



6500 Series User's Guide



May 2007

www.lexmark.com

Safety information

Use only the power supply and power supply cord provided with this product or the manufacturer's authorized replacement power supply and power supply cord.

Connect the power supply cord to a properly grounded electrical outlet that is near the product and easily accessible.

 **CAUTION:** Do not twist, bind, crush, or place heavy objects on the power cord. Do not subject the power cord to abrasion or stress. Do not pinch the power cord between objects such as furniture and walls. If the power cord is misused, a risk of fire or electrical shock results. Inspect the power cord regularly for signs of misuse. Remove the power cord from the electrical outlet before inspecting it.

Refer service or repairs, other than those described in the user documentation, to a professional service person.

This product is designed, tested, and approved to meet strict global safety standards with the use of specific Lexmark components. The safety features of some parts may not always be obvious. Lexmark is not responsible for the use of other replacement parts.

 **CAUTION:** Do not use the fax feature during a lightning storm. Do not set up this product or make any electrical or cabling connections, such as the power supply cord or telephone, during a lightning storm.

SAVE THESE INSTRUCTIONS.

Contents

Safety information.....	2
Introduction.....	13
Finding information about the printer.....	13
Operating system notice.....	16
Wireless network compatibility.....	16
Setting up the printer.....	17
Checking the box contents.....	17
Understanding the parts of the printer.....	18
Standalone setup.....	20
Installing the printer on additional network computers.....	25
Setting up the printer on a Windows operating system.....	26
Getting the printer ready to fax.....	27
Using an RJ11 adapter.....	27
Choosing a fax connection	30
Connecting to an answering machine	30
Connecting directly to a telephone wall jack.....	32
Connecting directly to a telephone wall jack in Germany	32
Connecting to a computer with a modem	33
Connecting to a telephone.....	34
Setting up to fax while behind a PBX	36
Using a digital phone service.....	36
Understanding the control panel.....	36
Using the control panel.....	36
Saving settings	39
Understanding the Settings menu	40
Installing another language control panel.....	42
Installing the printer software.....	43
Understanding the printer software.....	43
Turning printing voice notification on or off.....	46
Installing an internal wireless print server.....	47
Configuring the optional internal wireless print server.....	48
What do the Wi-Fi indicator lights mean?.....	48
Security Information.....	48
Networking.....	49
General networking.....	49
Networking overview	49
Common home network configurations	49

What information do I need and where do I find it?	51
Finding the MAC address	51
Printing a network setup page	52
Finding a printer/print server located on remote subnets	52
Direct IP printing	52
Checking the port setting	53
Wireless networking.....	53
Using a wireless network connection	53
IP addresses.....	54
Finding the signal strength	55
Installing the printer on a network.....	55
Sharing the printer on a network	55
Configure network printers	56
Types of wireless networks	56
Tips for using network adapters	57
Advanced wireless setup.....	57
Creating an ad hoc wireless network using Windows	57
Adding a printer to an existing ad hoc wireless network using Windows	59
Loading paper and original documents.....	60
Loading paper.....	60
Using the automatic paper type sensor.....	60
Loading envelopes.....	61
Loading labels.....	61
Loading greeting cards, index cards, photo cards, and postcards.....	62
Loading transparencies.....	62
Loading iron-on transfers.....	62
Loading custom-size paper.....	63
Loading banner paper.....	63
Loading original documents on the scanner glass.....	63
Loading original documents into the Automatic Document Feeder.....	65
Printing.....	67
Printing basic documents.....	67
Printing a document.....	67
Printing a Web page	67
Printing photos or images from a Web page	68
Printing multiple copies of a document.....	68
Collating copies	69
Printing the last page first (reverse page order)	69
Printing multiple pages on one sheet (N-Up).....	69
Printing document files from a memory card or flash drive	69
Pausing print jobs	70
Canceling print jobs	70

Printing specialty documents.....	71
Choosing compatible specialty paper types	71
Printing envelopes	71
Printing greeting cards, index cards, photo cards, and postcards.....	71
Printing a document as a poster.....	72
Printing an image as a poster.....	72
Printing a booklet.....	73
Assembling a booklet	73
Printing on custom-size paper	73
Printing iron-on transfers	74
Printing transparencies.....	74
Printing a banner	74
Printing on both sides of the paper (duplexing).....	75
Understanding the two-sided printing (duplexing) function.....	75
Printing on both sides of the paper (duplexing) automatically.....	75
Printing on both sides of the paper (duplexing) manually.....	76
Changing printer settings.....	76
Saving and deleting print settings.....	76
Resetting printer software to factory default settings.....	77

Working with photos.....78

Retrieving and managing photos.....	78
Inserting a memory card.....	78
Inserting a flash drive	79
Understanding the Photo Card menu	80
Connecting a PictBridge-enabled digital camera.....	81
Understanding the PictBridge menu.....	82
Transferring photos from a memory device to the computer using the control panel.....	83
Transferring all photos from a memory card using the computer	83
Transferring selected photos from a memory card using the computer	84
Transferring all photos from a CD or flash drive using the computer	84
Transferring selected photos from a CD or flash drive using the computer	85
Transferring photos from a memory card to a flash drive.....	85
Changing the Productivity Studio temporary files preferences.....	86
Changing the Productivity Studio searched folders preferences.....	86
Changing the Productivity Studio library preferences.....	87
Changing the Productivity Studio transfer settings.....	87
Editing photos.....	87
Cropping a photo	87
Rotating a photo	87
Changing the Resolution / Size of a photo	87
Applying One-Click Auto Fixes to a photo	88
Reducing the red-eye effect in a photo.....	88
Blurring/Sharpening a photo.....	88
Enhancing a photo.....	89
Changing the Hue / Saturation of a photo	89

Changing the Gamma Value of a photo or image	89
Despeckling a photo	89
Changing the Brightness / Contrast settings of a photo	90
Applying a color effect to a photo	90
Changing the Exposure setting of a photo	90
Removing wavy patterns from scanned photos, magazines, or newspapers.....	90
Printing photos.....	91
Printing photos from a CD or removable storage device using the computer	91
Viewing / Printing photos from the Productivity Studio	91
Printing Photo Packages	92
Creating Photo Greeting Cards	92
Printing all photos from a memory device	93
Printing photos stored on the memory device using the proof sheet.....	93
Printing photos by number.....	94
Using a PictBridge-enabled digital camera to control printing photos	95
Printing photos from a digital camera using DPOF	96
Printing photos by date range.....	96
Printing photos using color effects.....	96
Creating and viewing a slideshow.....	97
Copying.....	98
Understanding the Copy menu.....	98
Copying on both sides of the paper using the scanner glass.....	99
Copying on both sides of the paper using the Automatic Document Feeder (ADF).....	99
Copying photos.....	100
Copying a photo using the computer.....	101
Adjusting copy quality.....	101
Making borderless copies using the control panel.....	102
Making a copy lighter or darker.....	102
Collating copies using the control panel.....	103
Repeating an image on one page.....	103
Enlarging or reducing an image.....	104
Modifying the Copy settings.....	104
Scanning.....	105
Scanning a document.....	105
Scanning a document using the computer.....	105
Scanning text for editing.....	106
Scanning images for editing.....	106
Scanning a photo to Work with Documents and Photos.....	106
Scanning multiple photos at one time using the computer.....	107
Creating a PDF from a scanned item.....	107

Canceling a scan job.....	108
Customizing scan settings using the computer.....	108
Understanding the Scan menu.....	108
Scanning to a computer over a network.....	109
Saving a scanned image on the computer.....	109
Scanning clear images from magazines or newspapers.....	110
Changing the Productivity Studio scan settings.....	110
Adding a file to an e-mail message.....	111
Adding a new scanned image to an e-mail message.....	111
Scanning documents or images for e-mailing.....	111
Changing the Productivity Studio e-mail screen preferences.....	112
Faxing.....	113
Sending a fax.....	113
Entering a fax number.....	113
Sending a fax using the software.....	113
Sending a fax using the control panel.....	114
Sending a fax while listening to a call (On Hook Dial).....	115
Sending a broadcast fax at a scheduled time.....	115
Receiving a fax.....	116
Receiving a fax manually.....	116
Setting a fax manual answer code.....	116
Using Caller ID from the control panel.....	116
Using Caller ID from the software.....	117
Receiving a fax automatically.....	117
Receiving a fax with an answering machine.....	117
Receiving a two-sided fax.....	118
Forwarding faxes.....	118
Using the Phone Book.....	119
Using the control panel Phone Book.....	119
Using the computer Phone Book.....	120
Customizing fax settings.....	120
Customizing settings using the Fax Setup Utility.....	120
Understanding the Fax menu.....	123
Setting Auto Answer to on.....	124
Setting up a fax footer using the control panel.....	124
Creating a fax cover page using the Productivity Studio.....	125
Blocking junk faxes.....	125
Blocking unwanted changes to fax settings.....	126
Using the Fax Solutions Software.....	126
Setting up a dialing prefix.....	127
Setting the distinctive ring.....	127
Setting the number of rings before receiving a fax automatically.....	128
Setting up Speed Dial.....	128

Printing fax activity reports.....	129
Maintaining the printer.....	130
Removing a used print cartridge.....	130
Installing print cartridges.....	130
Refilling print cartridges.....	132
Using genuine Lexmark print cartridges.....	132
Aligning print cartridges.....	133
Cleaning the print cartridge nozzles.....	133
Wiping the print cartridge nozzles and contacts.....	133
Preserving the print cartridges.....	134
Cleaning the scanner glass.....	135
Cleaning the exterior of the printer.....	135
Ordering supplies.....	135
Ordering print cartridges.....	135
Ordering paper and other supplies.....	136
Troubleshooting.....	137
Setup Troubleshooting.....	137
Incorrect language appears on the display.....	137
Power button is not lit.....	138
Software does not install.....	138
Page does not print.....	139
Cannot print from digital camera using PictBridge.....	140
Understanding Warning levels.....	140
Removing and reinstalling the software.....	141
Enabling the USB port.....	141
Solving printer communication problems.....	142
Wireless troubleshooting.....	142
How do I find out what type of security my network is using?.....	142
Check your security keys.....	142
Printer is configured correctly, but cannot be found on the network.....	143
Wireless network printer does not print.....	143
Network printer does not show up in the printer selection list during installation.....	144
Wi-Fi indicator is not lit.....	145
Wi-Fi indicator light is blinking orange during installation.....	145
Wi-Fi indicator light is orange.....	147
Wireless printer is no longer working.....	148
Changing wireless settings after installation.....	149
Resetting an internal wireless print server to factory default settings.....	149
Printer cannot connect to the wireless network.....	150
Wireless Setup Utility cannot communicate with the printer during installation (Windows users only).....	151
Checking your network name (Windows users only).....	151

Ping the access point	152
Ping the printer	152
Run the Wireless Setup Utility (Windows users only).....	153
Check printer ports (Windows users only).....	153
Print troubleshooting.....	154
Partial 4 x 6 in. (10 x 15 cm) photo prints when using a PictBridge-enabled digital camera	154
Improving print quality	154
Poor text and graphic quality	155
Poor quality at the edges of the page.....	156
Print speed is slow.....	157
Partial document or photo prints.....	158
Photo smudges or scratches	158
Checking the print cartridges.....	158
Ink levels seem incorrect.....	158
Ink levels seem to go down too quickly	159
A blank or incorrect page prints.....	159
Characters on printout are missing or unexpected.....	159
Colors on printout are faded or differ from colors on the screen	160
Glossy photo paper or transparencies stick together	160
Page prints with different fonts	160
Print is too dark or smudged.....	161
Printed characters are improperly formed or are not aligned correctly.....	161
Printouts have alternating bands of light and dark print	161
Transparencies or photos contain white lines	162
Vertical straight lines are not smooth	162
White lines appear in graphics or solid black areas	162
Checking the printer status.....	163
Settings are not saved.....	163
Checking printer readiness.....	164
Checking the Spool Settings for banner printing	164
Resolving font problems	164
Printer is busy printing another job	165
Ready or Busy Printing is listed as the status	165
Printing a test page.....	165
Test page does not print.....	166
External print server is not working	167
Removing an external print server.....	167
Cable is not connected, is loose, or is damaged.....	167
Printer is plugged in but does not print.....	167
Printer is trying to print to File.....	168
Printer cannot communicate with computers over peer-to-peer network	168
Printer is not able to communicate with the computer	169
Problems when copying, scanning, or faxing	169
Wrong printer is attached	170
Updating the printer software	170
Bidirectional communication is not established.....	170
Experiencing poor quality or incorrect output	171

Cannot print to the network printer	171
Cannot print documents from a flash drive	172
Resetting the printer to factory default settings	172
Jams and misfeeds troubleshooting.....	172
How to clear and avoid paper jams	172
Paper jam in the printer	173
Paper jam in the paper support	173
Paper or specialty media misfeeds.....	173
Printer does not feed paper, envelopes, or specialty media.....	174
Banner paper jams	174
Paper continues to jam.....	175
Paper jam in the Automatic Document Feeder (ADF)	175
Paper jam in the duplex unit.....	175
Duplex unit does not operate correctly	176
Memory card troubleshooting.....	176
Memory card cannot be inserted.....	176
Nothing happens when memory card is inserted	177
Photos do not transfer from a memory card across a wireless network.....	177
Copy troubleshooting.....	178
Copier does not respond	178
Scanner unit does not close	178
Poor copy quality	179
Partial document or photo copies	180
Copied item does not match the original item	180
Scan troubleshooting.....	180
Scanner does not respond	180
Scan was not successful	181
Scanning takes too long or freezes the computer	181
Poor scanned image quality	182
Partial document or photo scans.....	182
Cannot scan to a computer over a network.....	182
Fax troubleshooting.....	183
Cannot send or receive a fax.....	183
Can send but not receive faxes	185
Can receive but not send faxes	185
Printer receives a blank fax	187
Received fax has poor print quality	187
Caller ID information is not displayed	188
Changing Caller ID pattern using the control panel.....	188
Fax Error.....	188
Fax Mode Unsupported	188
Remote Fax Error	189
Phone Line Busy	189
Failed to Connect	190
Phone Line Error	191
Error messages on the printer display.....	191

Alignment Error.....	191
Cartridge Error (1102, 1203, 1204, or 120F).....	192
Black Ink Low / Color Ink Low / Photo Ink Low.....	192
Clear Carrier Jam	192
Cover Open	193
Error 1104.....	193
Left Cartridge Error / Right Cartridge Error.....	193
Left Cartridge Incorrect / Right Cartridge Incorrect.....	193
Left Cartridge Missing / Right Cartridge Missing	194
Memory Failure.....	194
No images have been selected	194
No photo/paper size selection has been made	195
Could not detect a proof sheet	195
No proof sheet information	195
No valid photo image files detected.....	195
Only one photo enhancement may be chosen at a time	195
Only one photo/size selection can be chosen at a time	195
Paper/Photo Size Error.....	195
PictBridge communications error.....	196
Please remove the camera card.....	196
Some photos removed from card by host.....	196
Problems reading the memory card	196
2-Sided Paper Type Error.....	196
File Not Supported.....	196
Unsupported Paper Size	197
Error messages on the computer screen.....	197
Clearing error messages	197
Left/Right Cartridge Missing	197
Communication not available	197
General Printing Problem	198
Ink Low	198
Out of Memory.....	198
Out of Paper	198
Fixing a printing failure	198
Unsupported file types found on memory card.....	199
Paper Jam	199
Multiple All-In-Ones found	199
Notices.....	200
Product information.....	200
Edition notice.....	200
European EC directives conformity.....	202
Power consumption.....	207

Networking glossary.....	212
Index.....	214

Introduction

Finding information about the printer



Quick Setup sheet

Description	Where to find
The <i>Quick Setup</i> sheet gives you instructions for setting up hardware and software.	You can find this document in the printer box or on the Lexmark Web site at www.lexmark.com .

User's Guide

Description	Where to find
<p>The <i>User's Guide</i> gives you instructions for setting up hardware and software (on Windows operating systems) and some basic instructions for using the printer.</p> <p>Note: If your printer supports Macintosh operating systems, see the Mac Help:</p> <ol style="list-style-type: none">1 From the Finder desktop, double-click the Lexmark 6500 Series folder.2 Double-click the printer Help icon.	You can find this document in the printer box or on the Lexmark Web site at www.lexmark.com .

User's Guide: Comprehensive Version

Description	Where to find
<p>The <i>User's Guide: Comprehensive Version</i> gives you instructions for using the printer and other information such as:</p> <ul style="list-style-type: none"> • Using the software (on Windows operating systems) • Loading paper • Printing • Working with photos • Scanning (if supported by your printer) • Making copies (if supported by your printer) • Faxing (if supported by your printer) • Maintaining the printer • Connecting the printer to a network (if supported by your printer) • Troubleshooting problems with printing, copying, scanning, faxing, paper jams, and misfeeds <p>Note: If your printer supports Macintosh operating systems, see the Mac Help:</p> <ol style="list-style-type: none"> 1 From the Finder desktop, double-click the Lexmark 6500 Series folder. 2 Double-click the printer Help icon. 	<p>When you install the printer software, the <i>User's Guide: Comprehensive Version</i> will be installed.</p> <ol style="list-style-type: none"> 1 Do one of the following: <ul style="list-style-type: none"> • In Windows Vista, click . • In Windows XP and earlier, click Start. 2 Click Start → Programs or All Programs → Lexmark 6500 Series. 3 Click User's Guide. <p>If the link to the <i>User's Guide</i> is not on your desktop, follow these instructions:</p> <ol style="list-style-type: none"> 1 Insert the CD. The installation screen appears. Note: If necessary, click  → All Programs → Run. In Windows XP and earlier versions, click Start → Run, and then type D:\setup, where D is the letter of your CD-ROM drive. 2 Click Documentation. 3 Click View User's Guide (including Setup Troubleshooting). 4 Click Yes. An icon of the <i>User's Guide</i> appears on your desktop, and the <i>User's Guide: Comprehensive Version</i> appears on the screen. <p>You can also find this document on the Lexmark Web site at www.lexmark.com.</p>

Lexmark Solution Center

Description	Where to find
<p>The Lexmark Solution Center software is included on your CD. It installs with the other software, if your printer connects to a computer.</p>	<p>To access the Lexmark Solution Center:</p> <ol style="list-style-type: none"> 1 Do one of the following: <ul style="list-style-type: none"> • In Windows Vista, click . • In Windows XP and earlier, click Start. 2 Click Start → Programs or All Programs → Lexmark 6500 Series. 3 Select Lexmark Solution Center.

Customer support

Description	Where to find (North America)	Where to find (rest of world)
Telephone support	<p>Call us at</p> <ul style="list-style-type: none"> • US: 1-800-332-4120 Monday–Friday (8:00 AM–11:00 PM ET) Saturday (Noon–6:00 PM ET) • Canada: 1-800-539-6275 <i>English</i> Monday–Friday (8:00 AM–11:00 PM ET) Saturday (Noon–6:00 PM ET) <i>French</i> Monday–Friday (9:00 AM–7:00 PM ET) • Mexico: 01-800-253-9627 Monday–Friday (8:00 AM–8:00 PM ET) <p>Note: Support numbers and times may change without notice. For the most recent phone numbers available, see the printed warranty statement that shipped with your printer.</p>	<p>Telephone numbers and support hours vary by country or region.</p> <p>Visit our Web site at www.lexmark.com. Select a country or region, and then select the Customer Support link.</p> <p>Note: For additional information about contacting Lexmark, see the printed warranty that shipped with your printer.</p>
E-mail support	<p>For e-mail support, visit our Web site: www.lexmark.com.</p> <ol style="list-style-type: none"> 1 Click CUSTOMER SUPPORT. 2 Click Technical Support. 3 Select your printer family. 4 Select your printer model. 5 From the Support Tools section, click e-Mail Support. 6 Complete the form, and then click Submit Request. 	<p>E-mail support varies by country or region, and may not be available in some instances.</p> <p>Visit our Web site at www.lexmark.com. Select a country or region, and then select the Customer Support link.</p> <p>Note: For additional information about contacting Lexmark, see the printed warranty that shipped with your printer.</p>

Limited Warranty

Description	Where to find (US)	Where to find (rest of world)
<p>Limited Warranty Information</p> <p>Lexmark International, Inc. furnishes a limited warranty that this printer will be free of defects in materials and workmanship for a period of 12 months after the original date of purchase.</p>	<p>To view the limitations and conditions of this limited warranty, see the Statement of Limited Warranty included with this printer, or set forth at www.lexmark.com.</p> <ol style="list-style-type: none"> 1 Click CUSTOMER SUPPORT. 2 Click Warranty Information. 3 From the Statement of Limited Warranty section, click Inkjet & All-In-One Printers. 4 Scroll through the Web page to view the warranty. 	<p>Warranty information varies by country or region. See the printed warranty that shipped with your printer.</p>

Record the following information (located on the store receipt and the back of the printer), and have it ready when you contact us so that we may serve you faster:

- Machine Type number
- Serial number
- Date purchased
- Store where purchased

Operating system notice

All features and functions are operating system-dependent. For complete descriptions:

- **Windows users**—See the *User's Guide*.
- **Macintosh users**—If your product supports Macintosh, see the Mac Help installed with the printer software.

Wireless network compatibility

Your printer contains an IEEE 802.11g wireless print server. Your printer is compatible with IEEE 802.11 b/g/n routers that are Wi-Fi certified. If you are having issues with an N router, verify with your router manufacturer that the current mode setting is compatible with G devices, as this setting varies depending on the router brand/model.

Setting up the printer

Checking the box contents

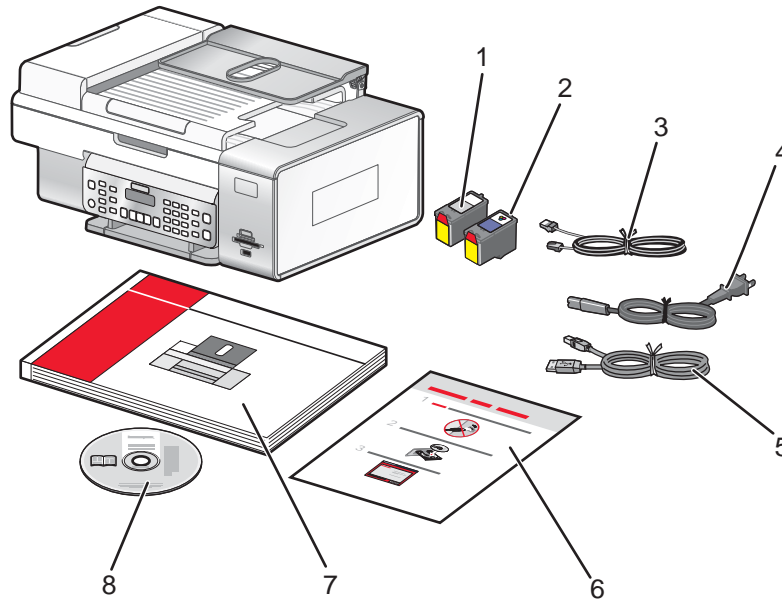

	Name	Description
1	Black print cartridge	Cartridges to be installed into the printer.
2	Color print cartridge	Note: Cartridge combinations vary depending on the product purchased.
3	Telephone cord	Use for faxing. For more information about connecting this cord, see “Choosing a fax connection” on page 30. Your telephone cord may look different from the one shown.
4	Power cord	Attaches to the power supply port located at the back of the printer. Note: Your power cord may look different from the one shown.
5	Installation cable	Connects the printer to the computer temporarily during some methods of installation.
6	<i>Quick Setup</i> sheet	Initial setup directions
7	<i>User's Guide</i>	Printed booklet that serves as a guide. Note: Complete user information (<i>User's Guide: Comprehensive Version</i> or <i>Mac Help</i>) can be found on the installation software CD.
8	Installation software CD for Windows and Mac	<ul style="list-style-type: none"> • Installation software for the printer • <i>User's Guide: Comprehensive Version</i> in electronic format • <i>Mac Help</i>

Understanding the parts of the printer

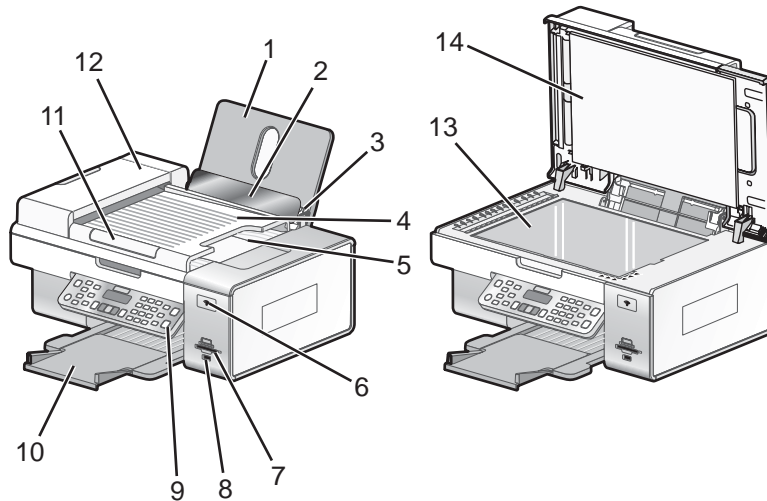

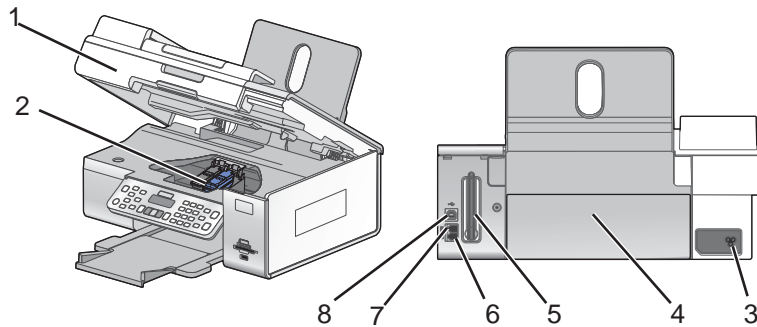

	Use the	To
1	Paper support	Load paper.
2	Paper feed guard	Prevent items from falling into the paper slot.
3	Paper guides	Keep paper straight when feeding.
4	Automatic Document Feeder (ADF) tray	Load original documents in the ADF. Recommended for scanning, copying, or faxing multiple-page documents. Note: Do not load postcards, photos, small items, or thin media (such as magazine clippings) into the ADF. Place these items on the scanner glass.
5	Automatic Document Feeder (ADF) output tray	Hold documents as they exit from the ADF.
6	Wi-Fi indicator	Check wireless status: <ul style="list-style-type: none"> • Off indicates that no wireless option is installed. • Orange indicates that the printer is ready for wireless connection, but not connected. • Green indicates that the printer is connected to a wireless network.
7	Memory card slots	Insert a memory card.
8	PictBridge port	Connect a PictBridge-enabled digital camera or a flash drive to the printer.
9	Control panel	Operate the printer. For more information, see “Using the control panel” on page 36.
10	Paper exit tray	Hold paper as it exits.
11	Automatic Document Feeder (ADF) paper guide	Keep paper straight when feeding into the ADF.
12	Automatic Document Feeder (ADF)	Scan, copy, or fax multiple-page letter-, legal-, and A4-size documents.

	Use the	To
13	Scanner glass	Copy or remove an item.
14	Top cover	Access the scanner glass.

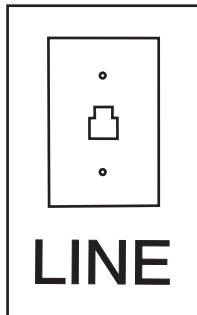

	Use the	To
1	Scanner unit	Access the print cartridges.
2	Print cartridge carrier	Install, replace, or remove a print cartridge.
3	Power supply with port	Plug the power cord into the power supply at the back of the printer and then into the wall outlet.
4	Duplex cover	<ul style="list-style-type: none"> • Print on both sides of a sheet of paper. • Remove paper jams.
5	Lexmark N2050 (internal wireless print server)	<p>Connect the printer to a wireless network.</p> <p>Note: The internal wireless print server may not come installed on all printers. To purchase the Lexmark N2050, see “Ordering paper and other supplies” on page 136.</p>
6	LINE port	<p>Connect the printer to an active telephone line to send and receive faxes. The printer must be connected to this telephone line to receive incoming fax calls.</p> <p>Note: Do not connect additional devices to the LINE port, and do not connect a DSL (digital subscriber line), ISDN (integrated services digital network), or cable modem to the printer.</p>



	Use the	To
7	EXT port 	Connect additional devices, such as data/fax modem, telephone, or answering machine to the printer. Note: Remove the plug to access the port.
8	USB port	Connect the printer to a computer using a USB cable. Warning: Do not touch the USB port except when plugging in or removing a USB cable or installation cable.

Standalone setup

1 Unpack the printer.

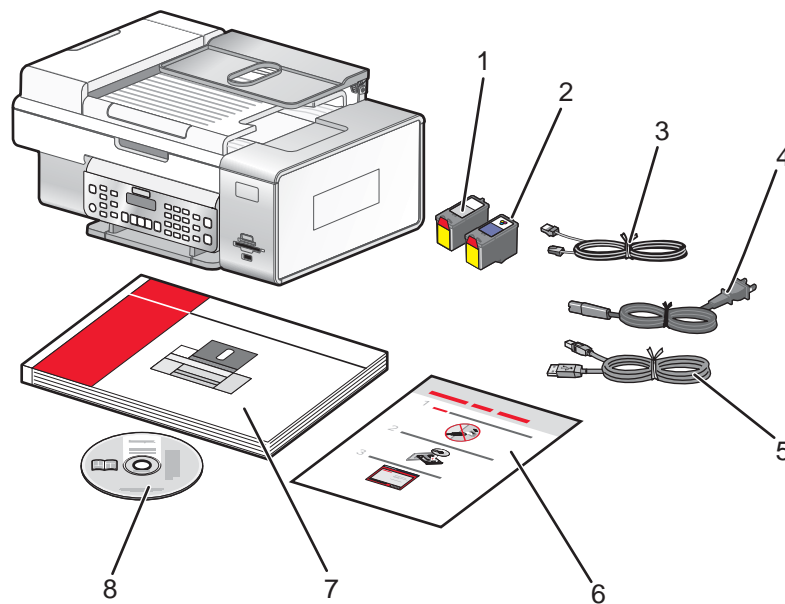

Notes:

- Place the printer near the computer during setup. If you're setting up on a wireless network, you may move the printer after setup is complete.
- You may need to purchase a USB cable separately.

2 Remove all tape and packing material from all areas of the printer.

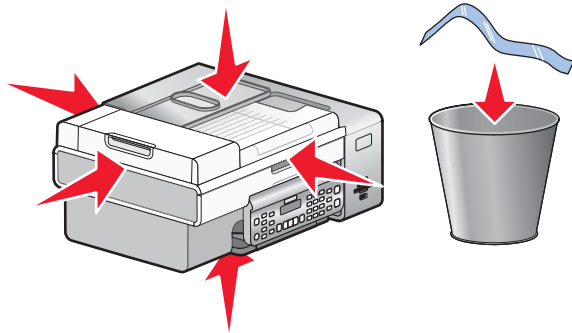

3 Raise the control panel.

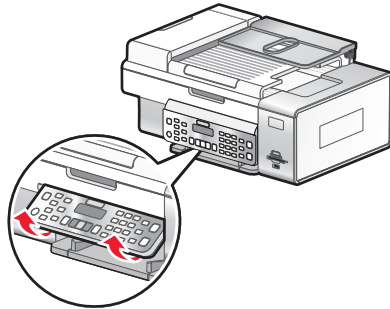

4 Extend the paper exit tray.

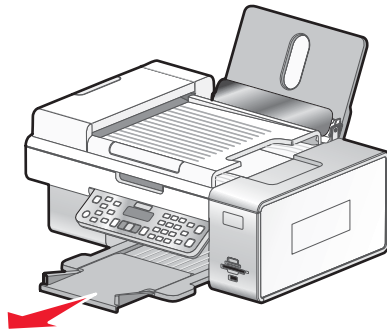

5 Raise the paper support.

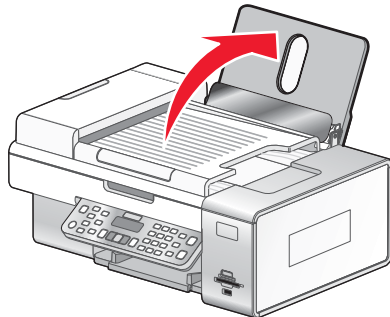

6 Extend the paper guides.

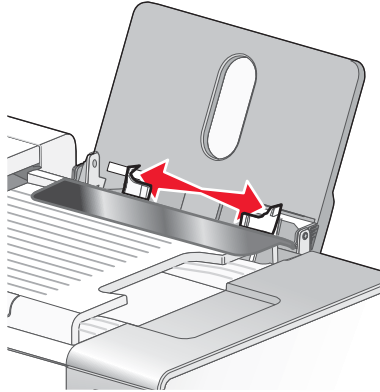

7 Load paper.

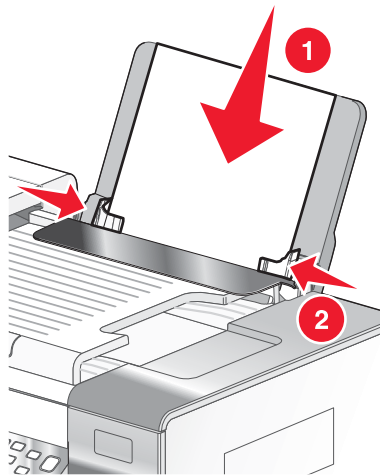

8 Connect the power cord.

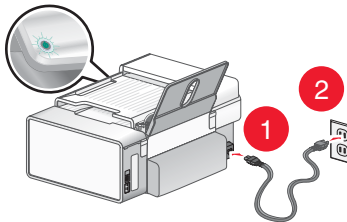

9 Make sure the power is on.

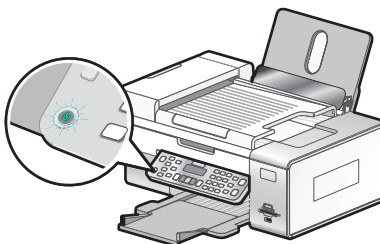

10 If prompted, set the language.

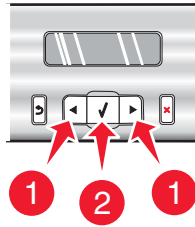

- a** Using the control panel of the printer, press ◀ or ▶ repeatedly until the language you want appears on the display.
- b** Press ✓ to save.

11 If prompted, set the country/region.

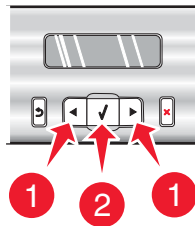

- a** Using the control panel of the printer, press ◀ or ▶ repeatedly until the country or region you want appears on the display.
- b** Press ✓ to save.

12 Open the printer.

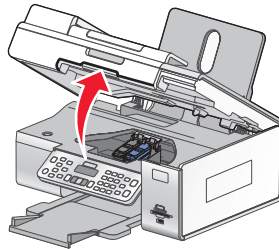

13 Press down on the cartridge carrier levers.

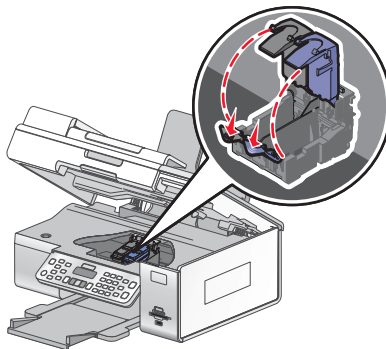

14 Remove the tape from the black print cartridge, and insert it in the left cartridge carrier.

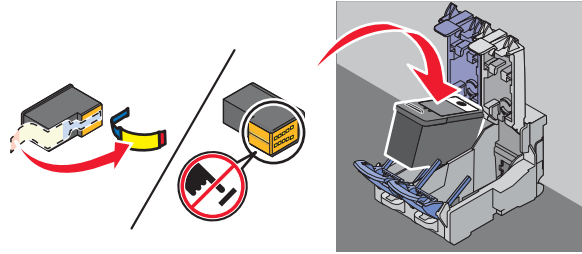

15 Close the black cartridge carrier lid

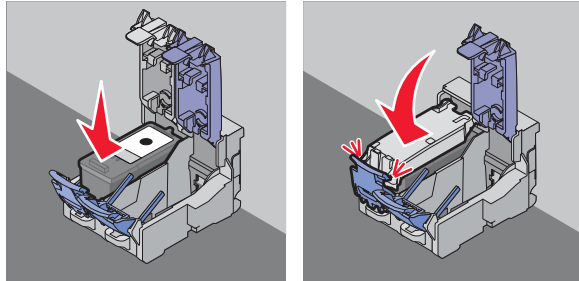

16 Remove the tape from the color print cartridge, and insert it in the right cartridge carrier.

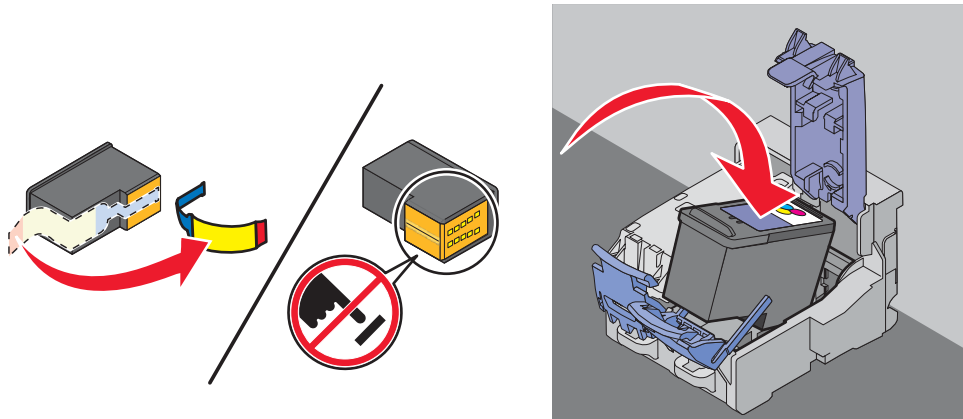

17 Close the color cartridge lid.

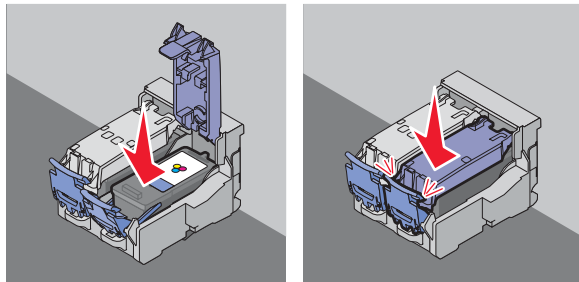

18 Close the printer.

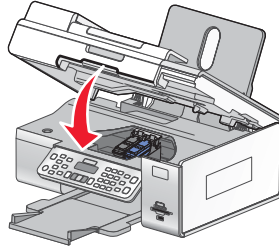

19 Press \checkmark .

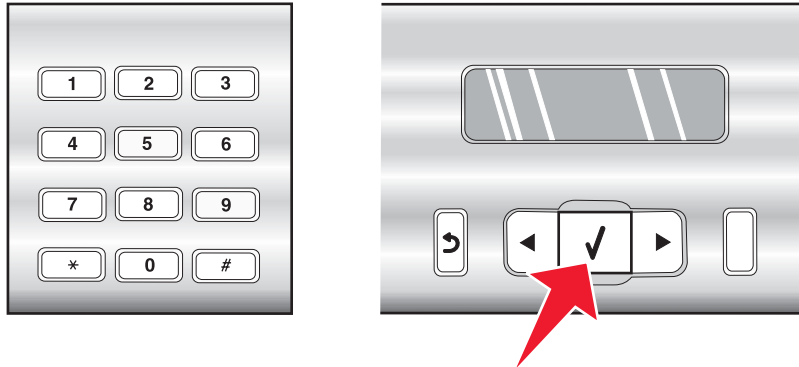

An alignment page prints.

20 Discard the alignment page.

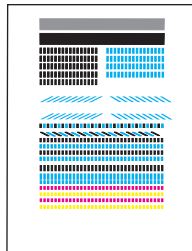

Notes:

- The alignment page that prints may differ from the one shown.
- Streaks on the alignment page are normal and not an indication of a problem.

Installing the printer on additional network computers

If you are installing your network printer for use with multiple computers on the network, insert the installation CD into each additional computer, and follow the instructions on the computer screen.

- You do not need to repeat the connection steps for each computer you want to print to the printer.
- The printer should appear as a highlighted printer in the installation. If multiple printers appear in the list, make sure you select the printer with the correct IP address/MAC address. If you need help finding the IP or MAC address, see “Finding the MAC address” on page 51.

Setting up the printer on a Windows operating system

1 Before you unpack the printer or attach anything, locate the CD for Windows.



2 Make sure the computer is on, and then insert the CD for Windows.

Wait several seconds for the install screen to appear.

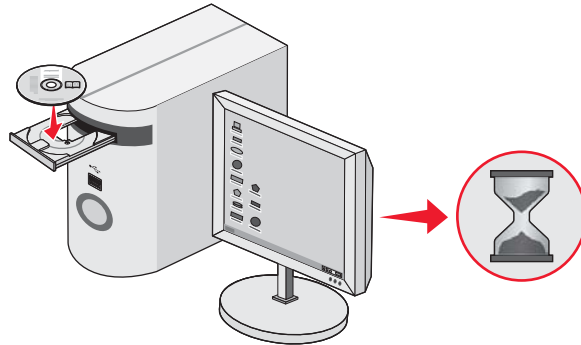

Note: If the install screen does not appear automatically, click **Start → Run**, and then type **D:\setup.exe**, where D is the letter of your CD-ROM drive.

3 Follow the instructions on the computer screen to set up the printer.

Your security software may notify you that Lexmark software is trying to communicate with your computer system. Always allow these programs to communicate. This is necessary for the printer to work properly.

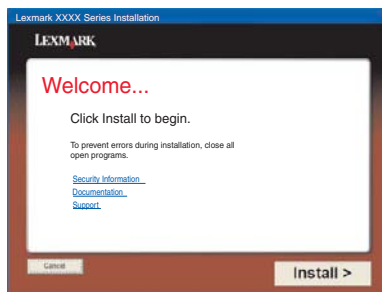

Getting the printer ready to fax

Using an RJ11 adapter

Country/region

- United Kingdom
- Ireland
- Finland
- Norway
- Denmark
- Italy
- Sweden
- Netherlands
- France
- Portugal

To connect your printer to an answering machine or other telecommunications equipment, use the telephone line adapter included in the box with the printer.

- 1 Connect one end of the telephone cord into the Line port  of the printer.

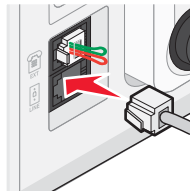

- 2 Connect the adapter to the telephone line that came with the printer.

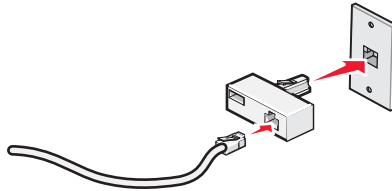

Note: The UK adapter is shown. Your adapter may look different, but it will fit the telephone outlet used in your location.

- 3 Connect the telephone line of your chosen telecommunications equipment to the left outlet of the adapter.

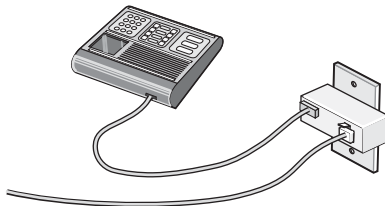

If your telecommunications equipment uses a US-style (RJ11) telephone line, follow these steps to connect the equipment:

- 1 Remove the plug from the EXT port on the back of the printer.

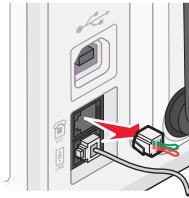

Note: Once this plug is removed, any country- or region-specific equipment you connect to the printer by the adapter, as shown, will not function properly.

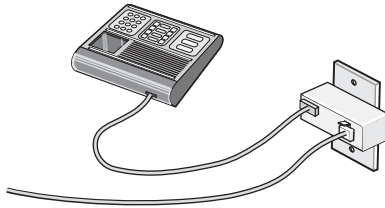

- 2 Connect your telecommunications equipment directly to the EXT port on the back of the printer.

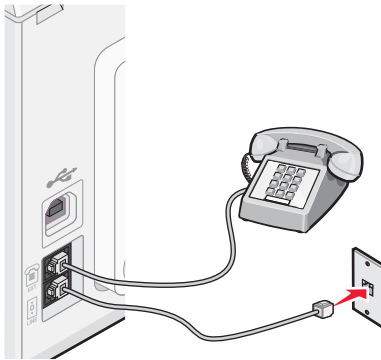

Warning: Do not touch cables or the printer in the area shown while actively sending or receiving a fax.

Country/region

- Saudi Arabia
- United Arab Emirates
- Egypt
- Bulgaria
- Czech Republic
- Belgium
- Australia
- South Africa
- Greece
- Israel
- Hungary
- Poland
- Romania
- Russia
- Slovenia
- Spain
- Turkey

To connect an answering machine or other telecommunications equipment to the printer:

- 1 Remove the plug from the back of the printer.

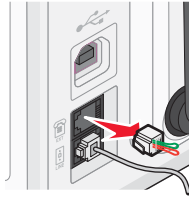

Note: Once this plug is removed, any country- or region-specific equipment that you connect to the printer by the adapter, as shown, will not function properly.

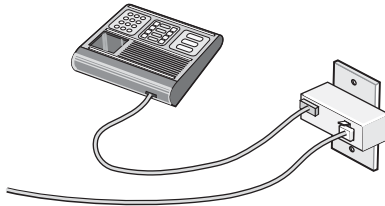

- 2 Connect your telecommunications equipment directly to the EXT port on the back of the printer.

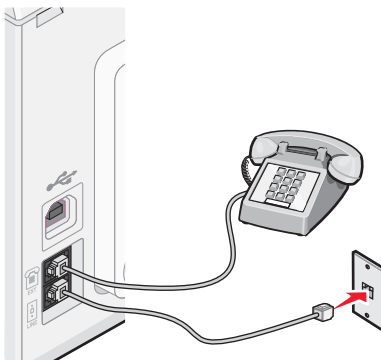

Warning: Do not touch cables or the printer in the area shown while actively sending or receiving a fax.

Country/region

- Germany
- Austria
- Switzerland

There is a plug installed in the EXT port of the printer. This plug is necessary for the proper functioning of the printer.

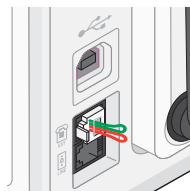

Note: Do not remove the plug. If you remove it, other telecommunications devices in your home (such as telephones or answering machines) may not work.

Choosing a fax connection

You can connect the printer with equipment such as a telephone, an answering machine, or a computer modem. If problems occur, see “Setup Troubleshooting” on page 137.

Note: The printer is an analog device that works best when directly connected to the wall jack. Other devices (such as a telephone or answering machine) can be successfully attached to pass through the printer, as described in the setup steps. If you want a digital connection such as ISDN, DSL, or ADSL, a third-party device (such as a DSL filter) is required.

You *do not* need to attach the printer to a computer, but you *do* need to connect it to a telephone line to send and receive faxes.

You can connect the printer to other equipment. See the following table to determine the best way to set up the printer.

Equipment	Benefits	See this section
<ul style="list-style-type: none">• The printer• A telephone cord	Send and receive faxes without using a computer.	“Connecting directly to a telephone wall jack” on page 32
<ul style="list-style-type: none">• The printer• A telephone• Two telephone cords	<ul style="list-style-type: none">• Use the fax line as a normal telephone line.• Send and receive faxes without using a computer.	“Connecting to a telephone” on page 34
<ul style="list-style-type: none">• The printer• A telephone• An answering machine• Three telephone cords	Receive both incoming voice messages and faxes.	“Connecting to an answering machine” on page 30
<ul style="list-style-type: none">• The printer• A telephone• A computer modem• Three telephone cords	Send faxes using the computer or the printer.	“Connecting to a computer with a modem” on page 33

Connecting to an answering machine

Connect an answering machine to the printer to receive both incoming voice messages and faxes.

Note: Setup steps may vary depending on your country or region. For more information on connecting the printer to telecommunications equipment, see the related topic, “Using an RJ11 adapter.”

1 Make sure you have the following:

- A telephone
- An answering machine
- Three telephone cords
- A telephone wall jack

2 Connect one telephone cord into the LINE port  of the printer, and then plug it into an active telephone wall jack.

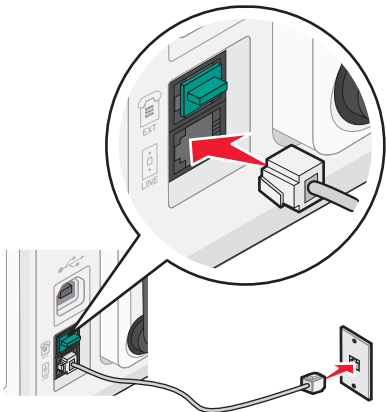

3 Remove the protective plug from the EXT port  of the printer.

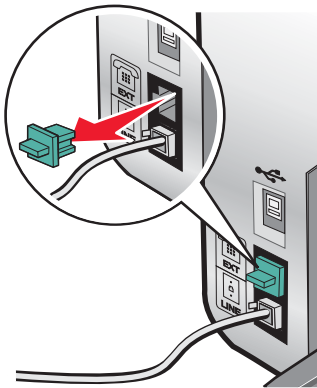

4 Connect a second telephone cord from the telephone to the answering machine.



5 Connect a third telephone cord from the answering machine to the EXT port  of the printer.

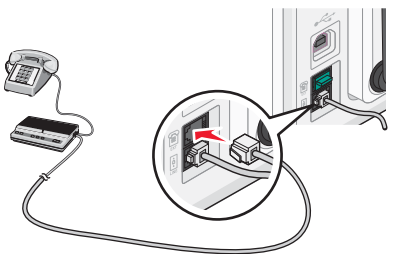

Connecting directly to a telephone wall jack

Connect the printer directly to a telephone wall jack to make copies or to send and receive faxes without using a computer.

- 1 Make sure you have a telephone cord and a telephone wall jack.
- 2 Connect one end of the telephone cord into the LINE port  of the printer.

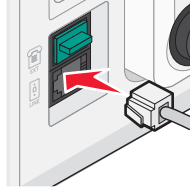

- 3 Connect the other end of the telephone cord into an active telephone wall jack.

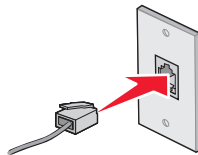

Connecting directly to a telephone wall jack in Germany

Connect the printer directly to a telephone wall jack to send and receive faxes without using a computer.

- 1 Make sure you have a telephone cord (provided with the product) and a telephone wall jack.
- 2 Connect one end of the telephone cord into the LINE port  of the printer.

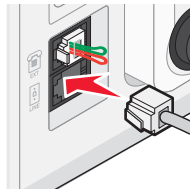

- 3 Connect the other end of the telephone cord into the N slot of an active telephone wall jack.

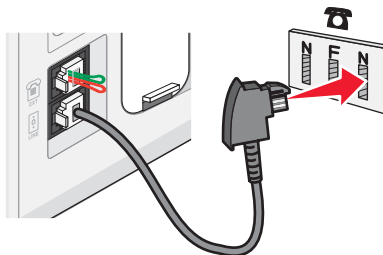

- 4 If you would like to use the same line for both fax and telephone communication, connect a second telephone line (not provided) between the telephone and the F slot of an active telephone wall jack.

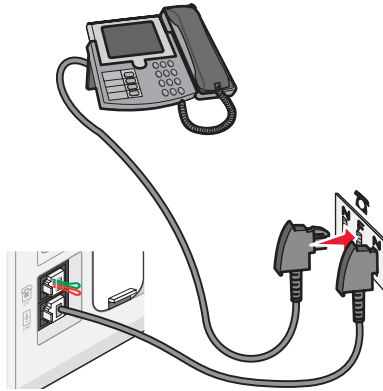

- 5 If you would like to use the same line for recording messages on your answering machine, connect a second telephone line (not provided) between the answering machine and the other N slot of the telephone wall jack.

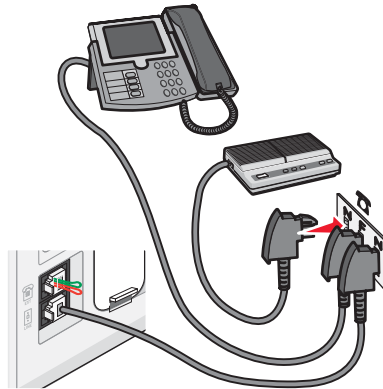

Connecting to a computer with a modem

Connect the printer to a computer with a modem to send faxes from the software application.

Note: Setup steps may vary depending on your country or region. For more information on connecting the printer to telecommunications equipment, see the related topic, "Using an RJ11 adapter."

- 1 Make sure you have the following:

- A telephone
- A computer with a modem
- Two telephone cords
- A telephone wall jack

- 2 Connect a telephone cord into the LINE port  of the printer, and then plug it into an active telephone wall jack.

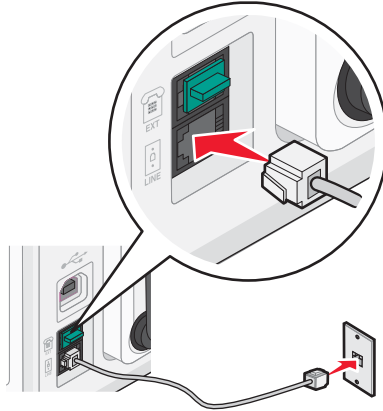

- 3 Remove the protective plug from the EXT port  of the printer.

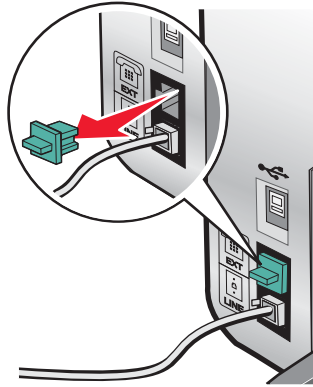

- 4 Connect a second telephone cord from the computer modem to the EXT port  of the printer.

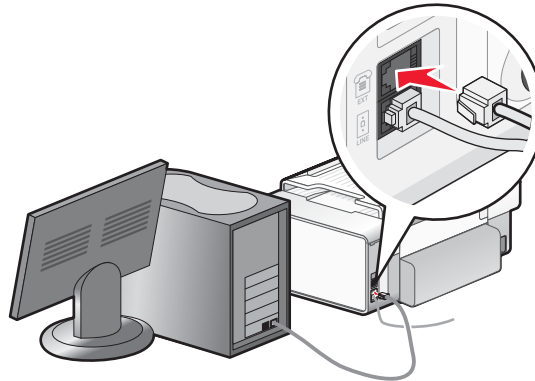

Connecting to a telephone

Connect a telephone to the printer to use the fax line as a normal telephone line. Then set up the printer wherever your telephone is located to make copies or to send and receive faxes without using a computer.

Note: Setup steps may vary depending on your country or region. For more information on connecting the printer to telecommunications equipment, see the related topic, “Using an RJ11 adapter.”

1 Make sure you have the following:

- A telephone
- Two telephone cords
- A telephone wall jack

2 Connect one telephone cord to the LINE port  of the printer, and then plug it into an active telephone wall jack.

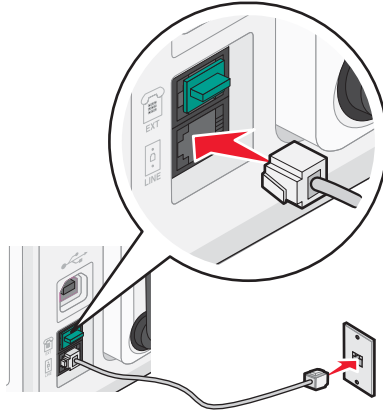

3 Remove the protective plug from the EXT port  of the printer.

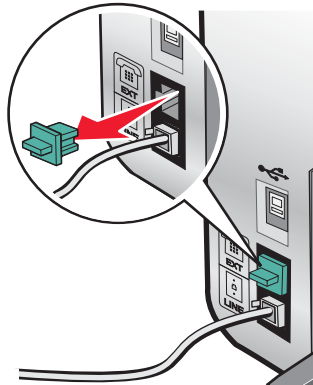

4 Connect the other telephone cord to a telephone, and then plug it into the EXT port  of the printer.

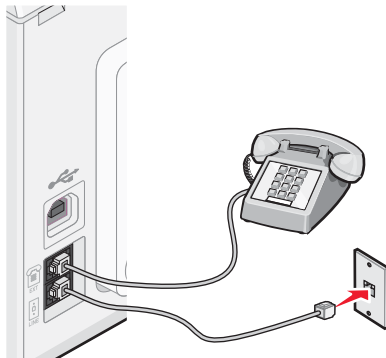

Setting up to fax while behind a PBX

If the printer is being used in a business or office, it may be connected to a Private Branch Exchange (PBX) telephone system. Ordinarily, when dialing a fax number, the printer waits to recognize the dial tone and then dials the fax number. However, this method of dialing may not work if the PBX telephone system uses a dial tone that is not recognizable to most fax machines. The “Dialing while behind a PBX” feature enables the printer to dial the fax number without waiting to recognize the dial tone.

- 1 From the desktop, double-click the **Productivity Studio** icon.
- 2 From the Settings area of the Welcome Screen, click **Fax History and Settings**.
- 3 From the “I Want To” menu, click **Adjust speed dial list and other fax settings**.
- 4 Click the **Dialing and Sending** tab.
- 5 From the “Dialing on your phone line” area, select **Behind PBX** from the Dialing Method drop-down list.
- 6 Click **OK** to save the setting.

Using a digital phone service

The fax modem is an analog device. Certain devices can be connected to the printer so that digital telephone services can be used.

- If you are using an ISDN telephone service, connect the printer to an analog telephone port (an R-interface port) on an ISDN terminal adapter. For more information and to request an R-interface port, contact your ISDN provider.
- If you are using DSL, connect to a DSL filter or router that will support analog use. For more information, contact your DSL provider.
- If you are using a PBX telephone service, make sure you are connecting to an analog connection on the PBX. If none exists, consider installing an analog telephone line for the fax machine. For more information on faxing when using a PBX telephone service, see the related topic, “Setting up to fax while behind a PBX.”

Understanding the control panel

Using the control panel

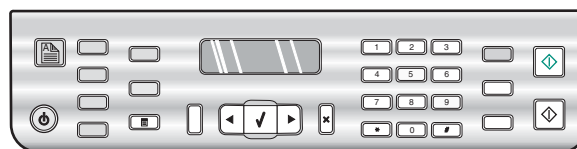

The control panel contains:

- Power on/off button
- Two-line display to show the printer status, messages, and menu items
- 30 buttons

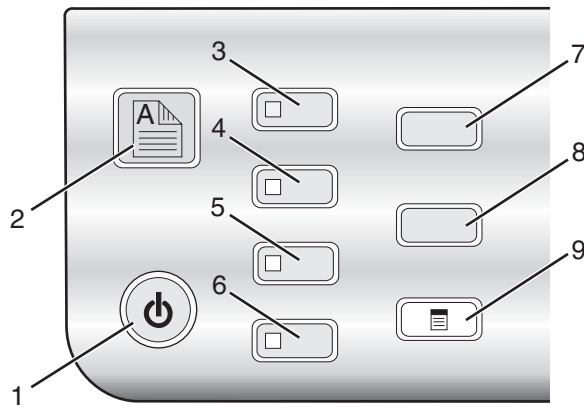

The following diagrams explain the sections of the control panel:



	Press	To
1		<ul style="list-style-type: none"> • Turn the printer on and off. • Stop the print, copy, scan, or fax process.
2		<p>Print on both sides of the paper (duplex). A green backlight comes on when the duplex function is activated.</p> <p>Note: This button is not functional with a Macintosh operating system. You can print two-sided documents with a Macintosh operating system by using the settings in the Two-Sided menu of the Print dialog.</p>
3	Copy Mode	<p>Access the copy default screen and make copies.</p> <p>Note: The mode is selected when the button light is on.</p>
4	Scan Mode	<p>Access the scan default screen and scan documents.</p> <p>Note: The mode is selected when the button light is on.</p>
5	Fax Mode	<p>Access the fax default screen and send faxes.</p> <p>Note: The mode is selected when the button light is on.</p>
6	Photo Card	<p>Access the photo default screen and print photos.</p> <p>Note: The mode is selected when the button light is on.</p>
7	Settings	<p>Access the settings default screen and change printer settings.</p> <p>Note: Other button lights are off when this button is selected.</p>
8	Lighter / Darker	Adjust the brightness of a copy, fax, or photo.
9		Display the Copy, Scan, Fax, or Photo Card menu, depending on which mode is selected.

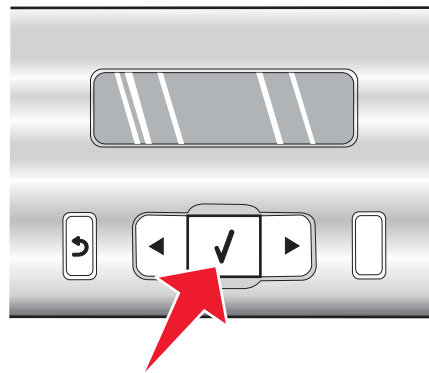
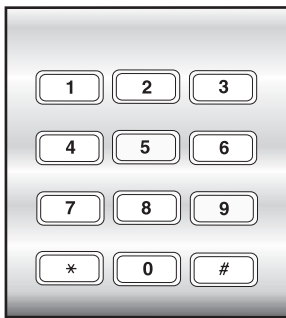

	Press	To
1		<ul style="list-style-type: none"> • Return to the previous screen. • Delete a letter or number.
2		<ul style="list-style-type: none"> • Decrease a number. • Delete a letter or number. • Scroll through menus, submenus, or settings on the display.
3		<ul style="list-style-type: none"> • Select a menu or submenu item that appears on the display. • Feed or eject paper.
4		<ul style="list-style-type: none"> • Increase a number. • Enter a space between letters or numbers. • Scroll through menus, submenus, or settings on the display.
5		<ul style="list-style-type: none"> • Cancel a print, copy, scan, or fax job in progress. • Clear a fax number or end a fax transmission and return to the fax default screen. • Exit a menu or submenu, and return to the default copy, scan, fax, or photo card screen. • Clear current settings or error messages, and return to default settings.

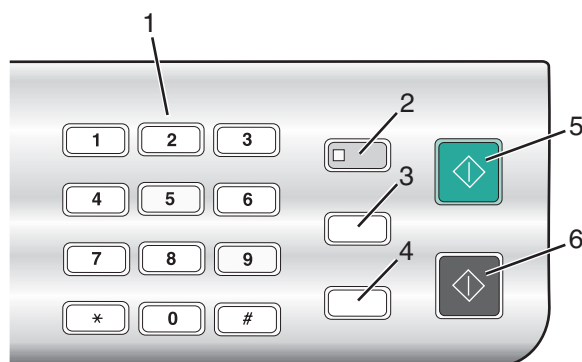

	Press	To
1	A keypad number or symbol	In Copy mode or Photo Card mode: Enter the number of copies or prints you want to make. In Fax mode: <ul style="list-style-type: none"> • Enter fax numbers. • Navigate an automated answering system. • Select letters when creating a Speed Dial list. • Type numbers to enter or edit the date and time shown on the display.
2	Auto Answer	Set the printer to answer all incoming calls when the button light is on.
3	Redial / Pause	In Fax mode: <ul style="list-style-type: none"> • Display the last number dialed. Press ◀ or ▶ to view the last five numbers dialed. • Insert a three-second pause in the number to be dialed to wait for an outside line or get through an automated answering system. Enter a pause only when you have already begun entering the number.
4	Phone Book	Access any of the programmed Speed Dial numbers (1–89) or Group Dial numbers (90–99).
5	Start Color	Start a color copy, scan, fax, or photo print job, depending on which mode is selected.
6	Start Black	Start a black-and-white copy, scan, fax, or photo print job, depending on which mode is selected.

Saving settings

In a setting menu, an * appears next to the default setting. To change the setting:

- 1 From the control panel, press **Settings**.
- 2 Press ◀ or ▶ repeatedly until the setting you want appears.
- 3 Press ✓:
 - To save most settings. An * appears next to the saved setting.
 - To select a temporary setting. An * appears next to the selected setting.

Note: The printer reverts to the default setting after two minutes of inactivity or if the printer is turned off. The Photo Card settings will not time out after two minutes of inactivity or turning off the power but will return to the default settings when a memory card or flash drive is removed.

To change the timeout feature:

- 1 Press **Settings**.
- 2 Press ◀ or ▶ repeatedly until **Device Setup** appears.
- 3 Press ✓.
- 4 Press ◀ or ▶ repeatedly until **Clear Settings Timeout** appears.
- 5 Press ✓.
- 6 Press ◀ or ▶ repeatedly until **Never** appears.
- 7 Press ✓.

To change one or more temporary settings into new default settings:

- 1 Press **Settings**.
- 2 Press ◀ or ▶ repeatedly until **Defaults** appears.
- 3 Press ✓.
- 4 Press ◀ or ▶ repeatedly until **Set Defaults** appears.
- 5 Press ✓.
- 6 Press ◀ or ▶ repeatedly until **Use Current** appears.
- 7 Press ✓.

Understanding the Settings menu

The Settings menu lets you perform maintenance functions and also change and save various printer settings. For information on saving temporary and other settings, see “Saving settings” on page 39.

- 1 From the control panel, press **Settings**.
- 2 Press ◀ or ▶ repeatedly until the menu item you want appears.
- 3 Press ✓.
- 4 Press ◀ or ▶ repeatedly until the submenu item you want or the setting you want appears.
- 5 Press ✓.
Note: When you choose a value selection, an asterisk (*) appears next to the selected setting.
- 6 To go into additional submenus and settings, repeat step 4 and step 5 as needed.
- 7 If necessary, press ↶ repeatedly to return to the previous menus and make other selections.

From here	You can
Maintenance	Select: <ul style="list-style-type: none"> • Ink Level to view the ink level of the color cartridge. Press ◀ or ▶ to view the ink level of the black (or photo) cartridge. • Clean Cartridges to clean the print cartridge nozzles. • Align Cartridges to align the cartridge. • Print Test Page to print a test page.
Paper Setup	Select the size and type of paper loaded.
Device Setup	Select: <ul style="list-style-type: none"> • Language to change the language setting. • Country to set the default blank paper size, date format, number of Caller ID patterns, and region selection being used in your location. • Date/Time to set the date and time. • Host Fax Settings to choose whether to allow the fax software from the computer to make changes in your fax settings. • Button Beep to set the volume of the tone when a control panel button is pressed to either On or Off. On is the default. • Power Saver to set the number of minutes before the printer, if left unused, enters the Power Saver mode. • Caller ID Pattern to choose from one of the following patterns available based on the country or region you selected during initial setup. If phones in your country use two detection patterns, call your telecommunications company to determine their subscribed pattern. <ul style="list-style-type: none"> – Pattern 1 (FSK) – Pattern 2 (DTMF) For more information, see “Using Caller ID from the control panel” on page 116. • Clear Settings Timeout to change the timeout feature before the printer, if left unused, resets to the factory default settings. For more information, see “Saving settings” on page 39.
Defaults	Select: <ul style="list-style-type: none"> • Photo Print Size to choose the size of photo(s) to print. • Set Defaults to change default settings. For more information, see “Saving settings” on page 39.

From here	You can
<p>Network Setup</p> <p>Note: This submenu item appears only when an internal wireless print server is installed in the printer.</p>	<p>Select:</p> <ul style="list-style-type: none"> • Print Setup Page to print a page that lists the network settings. • Wireless Setup to view: <ul style="list-style-type: none"> – Network Name, which shows the six characters unique to your specific printer. – Wireless Signal Quality, which shows the signal strength. – Reset Network Adapter to Factory Defaults, which lets you reset the wireless network settings. • TCP/IP to view the IP Address, IP Netmask, and IP Gateway of the printer. • Network Time to choose whether to enable the time server.

Installing another language control panel

These instructions apply only if you received one or more additional language control panels with the printer.

- 1 Lift the scanner unit.

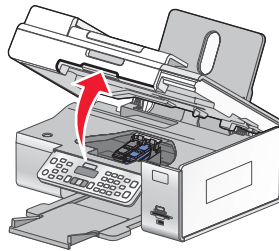

- 2 Grasp the control panel at the front. Lift and rotate it back to remove it (if one is installed).

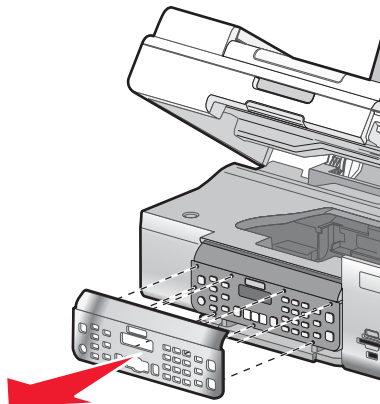

- 3 Choose the correct control panel for your language.
- 4 Align the tabs on the control panel with the holes on the printer. The control panel is at an angle.

- 5 Lower the control panel slightly at its front. Press the control panel down until it *snaps* into place.

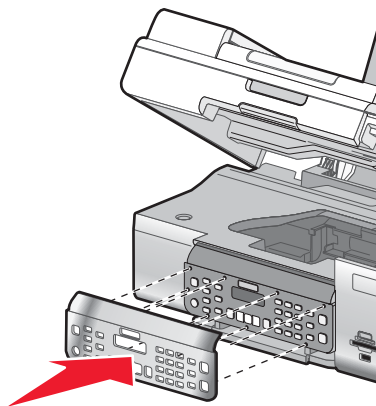

Installing the printer software

Using the installation software CD (Windows users only)

Using the CD that came with the printer:

- 1 Start Windows.
- 2 When the desktop appears, insert the software CD.
The software installation screen appears.
- 3 Click **Install**.

Using the installation software CD (Macintosh users only)

- 1 Close all open software applications.
- 2 Insert the software CD.
- 3 From the Finder desktop, double-click the printer CD icon that automatically appears.
- 4 Double-click the **Install** icon.
- 5 Follow the instructions on the computer screen.

Using the World Wide Web

- 1 Go to the Lexmark Web site at **www.lexmark.com**.
- 2 From the home page, navigate through the menu selection, and then click **Drivers & Downloads**.
- 3 Choose the printer and the printer driver for your operating system.
- 4 Follow the instructions on the computer screen to download the driver and install the printer software.







Understanding the printer software

Using the software that installed with your printer, you can edit photos, send faxes, maintain your printer, and do many other tasks. The following is an overview of features of the Productivity Studio and the Solution Center.

To open the Productivity Studio Welcome Screen, use one of these methods:

Method 1	Method 2
<p>From the desktop, double-click the Productivity Studio icon.</p>	<ol style="list-style-type: none"> 1 Do one of the following: <ul style="list-style-type: none"> • In Windows Vista, click . • In Windows XP and earlier, click Start. 2 Click Programs or All Programs → Lexmark 6500 Series. 3 Select Productivity Studio.

Click the **Productivity Studio** icon for the task you want to complete. Depending on the printer you have, some of the features of this software may not be applicable.

Click	To	Details
	Scan	<ul style="list-style-type: none"> • Scan a photo or document. • Save, edit, or share a photo or document.
	Copy	<ul style="list-style-type: none"> • Copy a photo or document. • Reprint or enlarge a photo.
	Fax	Send a photo or document as a fax.
	E-mail	Send a photo or document as an attachment to an e-mail message.
	Transfer Photos	Download photos from a memory card, flash drive, CD, or digital camera to the Library.
	Photo Greeting Cards	Make quality greeting cards from your photos.
	Photo Packages	Print multiple photos in various sizes.

Click	To	Details
	Poster	Print a photo as a multiple-page poster.



At the bottom left corner of the Welcome Screen, there are two Settings choices:

Click	To
Printer Status and Maintenance	<ul style="list-style-type: none"> • Open the Solution Center. • Check ink levels. • Order print cartridges. • Find maintenance information. • Select other Solution Center tabs for more information, including how to change printer settings and troubleshooting.
Fax History and Settings	Select printer fax settings for: <ul style="list-style-type: none"> • Dialing and Sending • Ringing and Answering • Fax Printing/Reports • Speed Dial and Group Dial numbers

The Solution Center is a complete guide to such printing features as printing photos, troubleshooting printing problems, installing print cartridges, and performing maintenance tasks. To open the Solution Center, use one of the following methods.

Method 1	Method 2
<ol style="list-style-type: none"> 1 From the desktop, double-click on the Solution Center icon. 2 Click Setup and diagnose printer. The Solution Center appears with the Maintenance tab open. 	<ol style="list-style-type: none"> 1 Do one of the following: <ul style="list-style-type: none"> • In Windows Vista, click . • In Windows XP and earlier, click Start. 2 Click Programs or All Programs → Lexmark 6500 Series. 3 Select Solution Center.

From here	You can:
How To 	<ul style="list-style-type: none"> • Learn how to: <ul style="list-style-type: none"> – Use basic features. – Print, scan, copy, and fax. – Print projects such as photos, envelopes, cards, banners, iron-on transfers, and transparencies. • Find the electronic <i>User's Guide</i> for more information. • View ink levels and order new print cartridges.

From here	You can:
Troubleshooting 	<ul style="list-style-type: none"> • Learn tips about the current status. • Solve printer problems. • View ink levels and order new print cartridges.
Advanced 	<ul style="list-style-type: none"> • Change the appearance of the Printing Status window. • Turn printing voice notification on or off. • Change network printing settings. • Share information with us regarding how you use the printer. • Obtain software version information. • View ink levels and order new print cartridges.
Maintenance 	<ul style="list-style-type: none"> • Install a new print cartridge. Note: Wait until scanning is complete before installing a new print cartridge. • Order new print cartridges. • Print a test page. • Clean print cartridges to fix horizontal streaks. • Align print cartridges to fix blurry edges. • View ink levels. • Troubleshoot other ink problems.

Turning printing voice notification on or off

The printer has a voice notification feature that tells you when printing starts and when it is completed.

To turn the voice notification on or off:

- 1 Do one of the following:
 - In Windows Vista, click .
 - In Windows XP and earlier, click **Start**.
- 2 Click **Start** → **Programs** or **All Programs** → **Lexmark 6500 Series**.
- 3 Click **Solution Center**.
- 4 Click **Advanced**.
- 5 Click **Printing Status**.
- 6 Select or clear **Play voice notification for printing events**.
- 7 Click **OK**.

Installing an internal wireless print server

The printer you purchased may contain an internal wireless print server that allows the printer to be used on a wireless network. If your printer does not have an internal wireless print server already installed, you can purchase one separately. Use the following instructions to install the internal wireless print server:

- 1 Turn off your printer, and then unplug the power cord from the wall outlet.

Warning: Failure to unplug the printer can cause damage to your printer and to the internal wireless print server. Make sure the printer is turned off and the power cord is unplugged from the wall outlet before you proceed.

- 2 Remove the back cover plate by pushing the tab down and then pulling the cover away from the printer.

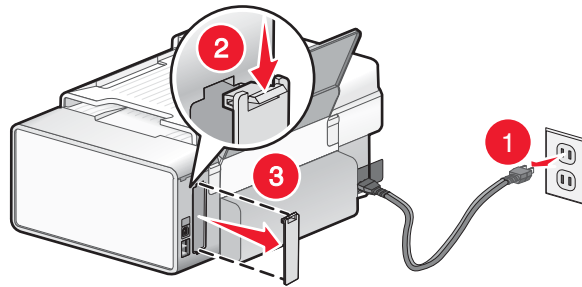

- 3 Unpack the internal wireless print server. Save the packaging materials.

Warning: Wireless print servers are easily damaged by static electricity. Touch something metal such as the printer frame before you touch the wireless print server.

- 4 Align the edges of the internal wireless print server with the guides on the left and right, and then slide the wireless print server into the printer until it *snaps* into place.

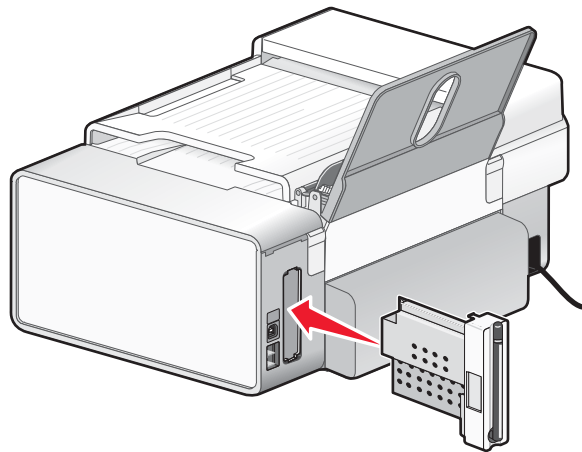

- 5 Make sure the antenna points up.

- 6 Attach the adhesive label with the MAC address to the back of the printer. You will need this later to network the printer.

You are now ready to configure the internal wireless print server to work on your wireless network.

Configuring the optional internal wireless print server

If you purchased the optional internal wireless print server after your printer was already set up, follow these steps:

- 1 Install the internal wireless print server into the printer. For more information, see “Installing an optional internal wireless print server” in the “Setting up the printer” chapter.
- 2 Click **Start** → **Programs** or **All Programs** → **Lexmark 6500 Series**.
- 3 Click **Wireless Setup**.
- 4 Click **Start**.
- 5 Follow the instructions on the computer screen.
- 6 Click **Finish** to complete the installation.

What do the Wi-Fi indicator lights mean?

- **Off** indicates that the printer is not turned on, or a wireless print server is not installed.

Select this option:

- If you want to connect the printer to the computer using a USB cable.
- If the printer does not have a wireless print server installed and you want to connect the printer to the computer using a USB cable.

- **Orange** indicates that the printer is ready to be configured for wireless printing, but it is not connected to a wireless network.

Select this option if you want to set up the printer on your wireless network.

- **Orange blinking** indicates that the printer is configured, but it is unable to communicate with the wireless network.

Select this option if you want to modify the wireless settings of the printer.

- **Green** indicates that the printer is connected to a wireless network.

Select this option to start using the printer that is already set up on your wireless network.

Security Information

Third-party applications, including anti-virus, security, and firewall programs may alert you about the printer software being installed. For your printer to work properly, allow the printer software to run on your computer.

Networking

General networking

Networking overview

A *network* is a collection of devices such as computers, printers, Ethernet hubs, wireless access points, and routers connected together for communication through cables or through a wireless connection. A network can be either wired, wireless, or designed to have both wired and wireless devices.

Devices on a wired network use cables to communicate with each other.

Devices on a wireless network use radio waves instead of cables to communicate with each other. For a device to be able to communicate wirelessly, it must have a wireless print server attached or installed that enables it to receive and transmit radio waves.

Common home network configurations

For desktop computers, laptops, and printers to communicate with each other over a network, they must be connected by cables and/or have wireless network adapters built in or installed in them.

There are different ways a network can be set up. Five common examples appear below.

Note: The printers in the following diagrams represent Lexmark printers with Lexmark internal print servers built in or installed in them so that they can communicate over a network. Lexmark internal print servers are devices made by Lexmark to enable Lexmark printers to be connected to wired or wireless networks.

Wired network example

- A computer, a laptop, and a printer are connected by Ethernet cables to a hub, router, or switch.
- The network is connected to the Internet through a DSL or a cable modem.

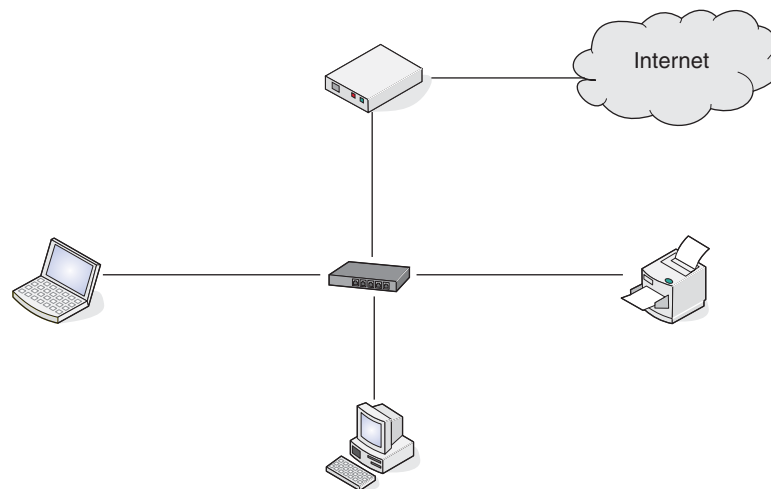

Wireless network examples

Four common wireless networks appear below:

- Scenario 1: Laptop and printer connected wirelessly with Internet
- Scenario 2: Computer, laptop, and printer connected wirelessly with Internet
- Scenario 3: Computer, laptop, and printer connected wirelessly without Internet
- Scenario 4: Laptop connected wirelessly to printer without Internet

Scenario 1: Laptop and printer connected wirelessly with Internet

- A computer is connected to a wireless router by an Ethernet cable.
- A laptop and a printer are connected wirelessly to the router.
- The network is connected to the Internet through a DSL or a cable modem.

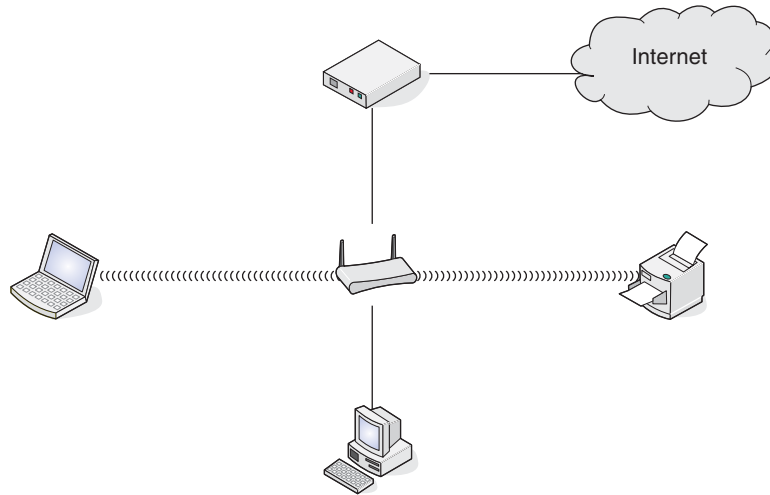

Scenario 2: Computer, laptop, and printer connected wirelessly with Internet

- A computer, a laptop, and a printer are connected wirelessly to a wireless router.
- The network is connected to the Internet through a DSL or a cable modem.

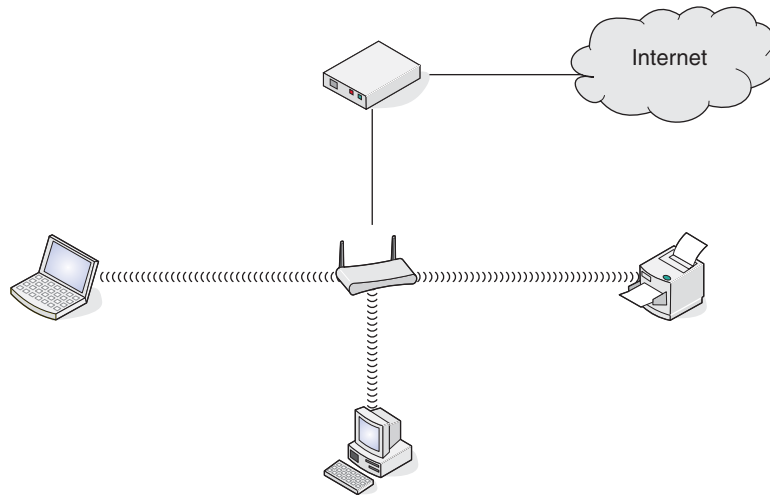

Scenario 3: Computer, laptop, and printer connected wirelessly without Internet

- A computer, a laptop, and a printer are connected wirelessly to a wireless access point.
- The network has no connection to the Internet.

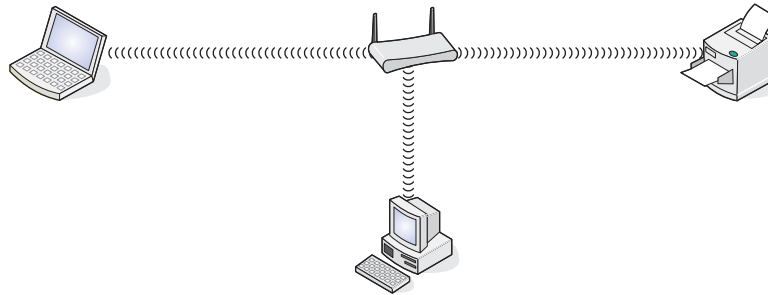

Scenario 4: Laptop connected wirelessly to printer without Internet

- A laptop is directly connected wirelessly to a printer without going through a wireless router.
- The network has no connection to the Internet.



What information do I need and where do I find it?

This printer may contain an internal wireless print server, which allows the printer to be used on a wireless network. You need the following settings from your existing wireless network:

- The network name, also known as the SSID
- The wireless mode (the type of wireless network you are using, either infrastructure or ad hoc)
- The type of security used on the network (WEP, WPA, or WPA2)
- Any applicable security keys or passwords used with the network security encryption type

Note: You must know this information in order to properly set up the printer for use on the wireless network. To obtain these settings, see the documentation that came with your wireless router or consult the person who set up your wireless network.

Finding the MAC address

Most network equipment has a unique hardware identification number to distinguish it from other devices on the network. This is called the *Media Access Control (MAC)* address.

If your printer has a factory installed internal wireless print server, the MAC address is a series of letters and numbers located on the back of your printer.

If you purchased the internal wireless print server separately, the MAC address appears on an adhesive label that came with the wireless print server. Attach the adhesive label to your printer so you will be able to find the MAC address when you need it.



Note: A list of MAC addresses can be set on a router so that only devices with matching MAC addresses can be allowed to operate on the network. This is called *MAC filtering*. If MAC filtering is enabled in your router and you want to add a printer to your network, the MAC address of the printer must be included in the MAC filter list.

Printing a network setup page

A network setup page lists your network configuration settings.

Note: You can print a network setup page only after a print server has been installed.

To print a network setup page:

- 1 From the control panel of the printer, press **Settings**.
- 2 Press ◀ or ▶ repeatedly until **Network Setup** appears.
- 3 Press ✓.
- 4 Press ◀ or ▶ repeatedly until **Print Setup Page** appears.
- 5 Press ✓.
- 6 Press ✓ again.

Finding a printer/print server located on remote subnets

The printer software CD can automatically find the printers that are located on the same network as the computer. If the printer and print server are located on another network (called a subnet), you must manually enter an IP address during printer software installation.

Direct IP printing

- 1 Connect the printer to an external print server using a USB cable.
- 2 Connect the print sever to the network using an Ethernet cable.

Note: You may be connecting your printer directly into a wall connection or through a router. For more information, see the print server documentation.

- 3 Insert the printer software CD.

- 4 Click **Install**.
- 5 From the “Connect Your Printer” dialog, select the network option.
- 6 From the “Networking Setup” dialog, select **Direct Network Attached**.
- 7 Select the printer/print server combination from the Network Printers list.

Note: If more than one is listed, match the MAC address of the print server to the one in the list. For more information, see “Finding the MAC address” on page 51.

Checking the port setting

Windows 2000 or XP users only:

- 1 Click **Start → Settings → Printers** or **Printers and Faxes**.
- 2 Right-click the **Lexmark 6500 Series** icon.
- 3 From the sidebar menu, select **Properties**.
- 4 Click the **Ports** tab.
- 5 Make sure:
 - The port is set to a **USB** port.
 - File is *not* set as the port.

Windows Vista users only:

- 1 Click **Start icon → Control Panel → Printers**.
- 2 Right-click the **Lexmark 6500 Series** icon.
- 3 From the sidebar menu, select **Properties**.
- 4 Click the **Ports** tab.
- 5 Make sure:
 - The port is set to a **USB** port.
 - File is *not* set as the port.

Wireless networking

Using a wireless network connection

This printer may contain an internal wireless print server, which allows the printer to be used on a wireless network. The following settings from your existing wireless network may be needed in order to properly configure the printer for use on the network:

- The network name, also known as the SSID
- The wireless mode (the type of wireless network you are using, either infrastructure or ad-hoc)
- The type of security used on the network (WEP, WPA, or WPA2)
- Any applicable security keys or passwords used with the network security encryption type

- 1 Insert the printer software CD.
- 2 Click **Install**.
- 3 Select **I agree to the terms of this License Agreement**, and then click **Continue**.

- 4 Select **Typical**, and then click **Continue**.
- 5 If this is the first time you have set up the printer, select **Yes**. If you have set up the printer previously and would like to install it on another computer, select **No**. Click **Continue**.
- 6 Follow the instructions on the next several screens to set up the paper tray, load paper, install the print cartridges, and align the cartridges.
- 7 Look at the W-Fi Indicator on your printer and select the matching option on the software screen.
- 8 Follow the instructions on the next several screens to continue with setup.
- 9 Select **Yes** to set up fax functions.
- 10 Follow the instructions on the next several screens to configure the fax settings appropriately for your equipment.
- 11 Print a sample page, and then click **Continue**.
- 12 If you want information on Lexmark promotions and discounts, select **Open my browser to the Lexmark Rewards registration page**. Click **Continue**.
- 13 If you want to print Web pages using shortcuts on the Toolbar, select **Install the Lexmark Toolbar**.
- 14 Click **Finish**.

IP addresses

Finding IP addresses

An IP address is a unique number used by devices on an IP network to locate and communicate with each other. Devices on an IP network can only communicate with each other if they have unique and valid IP addresses. A unique IP address means no two devices on the same network have the same IP address.

How to locate a printer IP address

You can locate the printer IP address by printing out the printer network setup page. For more information, see “Printing a network setup page” on page 52.

How to locate a computer IP address

- 1 Do one of the following:
 - In Windows Vista, click  → **All Programs** → **Accessories** → **Command Prompt**.
 - In Windows XP, click **Start** → **Programs** or **All Programs** → **Accessories** → **Command Prompt**.
- 2 Type **ipconfig**.
- 3 Press **Enter**.

The IP address appears as four sets of numbers separated by periods, such as 192.168.0.100.

Assigning an IP address

An IP address may be assigned by the network using DHCP. The print object, created at the end of the installation, sends all print jobs across the network to the printer using this address.

Many networks have the ability to automatically assign an IP address. Auto-IP is the ability for individual devices to assign themselves a unique IP address. Most networks use DHCP to assign addresses.

During the Direct IP printing installation of printer software, the IP address is visible in the printer list only as it is being assigned. The print object that is created in the Printers folder of the operating system will reference the MAC address of the printer in the port name.

If the IP address is not automatically assigned, you can try manually entering an address after selecting your printer from the available list.

Configure IP address

If you have lost communication with the printer over a network, select **Use DHCP** to reestablish communication with the printer.

You must assign an IP address in any of the following situations:

- You manually assigned IP addresses for the other network devices.
- You want to assign a specific IP address.
- You move the printer to a remote subnet.
- The printer is listed as **unconfigured** in the Configuration Utility.

Contact your system support person for more information.

Finding the signal strength

Wireless devices have built-in antennas that transmit and receive radio signals. The signal strength listed on the printer network setup page indicates how strongly a transmitted signal is being received. Many factors can affect the signal strength. One factor is interference from other wireless devices or even other devices such as microwave ovens. Another factor is distance. The farther two wireless devices are from each other, the more likely it is that the communication signal will be weaker.

Installing the printer on a network

Follow the instructions for the networking method you want to use. Make sure the selected network is set up and working properly, and that all relevant devices are turned on. For more information on your specific network, see your network documentation or consult the person who set up the network.

Sharing the printer on a network

Sharing the printer on the network (on the host computer)

Windows Vista users only:

- 1 For more information, see the setup information that came with your printer.
- 2 Click **Start icon → Control Panel → Printers**.
- 3 Right-click your printer icon, and select **Sharing**.
- 4 Click **Change sharing options**.
- 5 Click **Continue**.
- 6 Click **Share this printer**, and assign a name to your printer.
- 7 Follow the directions on the computer screen until installation is complete.

Windows 2000 or Windows XP users only:

- 1 For more information, see the setup information that came with your printer.
- 2 Click **Start → Settings → Printers**.
- 3 Right-click your printer icon, and select **Sharing**.
- 4 Click **Shared as**, and assign a name to your printer.
- 5 Follow the directions on the computer screen until installation is complete.

Installing the shared printer on other network computers (on the client computers)

Using the peer-to-peer method	Using the point-and-print method
<ol style="list-style-type: none"> 1 Go to a network computer that you want to enable to print to the shared printer. 2 Insert the printer software CD. 3 Agree to the license agreement, and then click Next. 4 Select Manual Setup. 5 From the Network Printer Setup dialog, select the Peer-to-Peer client option, and then click Next. 6 Select the appropriate printer from the list, and then click Next. 7 Select the software you want to install, and then click Next. 8 When setup is complete, click Finished. 9 Repeat this procedure for each network computer you want to access the shared printer. 	<ol style="list-style-type: none"> 1 Go to a network computer that you want to enable to print to the shared printer. 2 Browse the Network Neighborhood until you find the name of the shared printer assigned in step 4 on page 55. 3 Right-click the printer icon, and select Open or Connect. 4 This will copy a subset of the printer software from the host computer. A printer object will be created in the Printers folder of the client.

Configure network printers

Configure

To configure a network printer, select a printer from the list in the window. Click **Configure** to assign the printer an Internet Protocol (IP) address. Contact your system support person for more information.

Add printers

Specify remote subnets that may have direct network attached printers. If the software detects a direct network attached printer, you must first highlight the printer in the window, and then click **Configure** to manually assign an IP address to the printer. Contact your system support person for more information.

Note: The software does not automatically configure printers found on remote subnets.

Refresh

Click **Refresh** to have the Configuration Utility automatically search to find and configure newly added printers.

Types of wireless networks

Networks can operate in one of two modes: infrastructure or ad hoc. Lexmark recommends setting up a network in infrastructure mode using the installation CD that came with the printer.

A wireless network where each device communicates with others through a wireless access point (wireless router) is set up in infrastructure mode. All devices must have valid IP addresses and share the same SSID and channel. In addition, they must share the same SSID and channel as the wireless access point (wireless router).

A simple type of wireless network is one where a PC with a wireless adapter communicates directly with a printer equipped for wireless networking. This mode of communication is called *ad hoc*. A device in this type of network must have a valid IP address and be set to ad hoc mode. The wireless print server must also be configured with the same SSID and channel.

	Infrastructure	Ad hoc
Characteristics		

Communication	Through wireless access point (wireless router)	Directly between devices
Security	More security options	
Range	Determined by range and number of access points	Restricted to range of individual devices on network
Speed	Usually faster	Usually slower
Requirements for all devices on the network		
Unique IP address for each device	Yes	Yes
Mode set to	Infrastructure mode	Ad hoc mode
Same SSID	Yes, including the wireless access point (wireless router)	Yes
Same channel	Yes, including the wireless access point (wireless router)	Yes

Infrastructure mode is the recommended setup method because it has:

- Increased network security
- Increased reliability
- Faster performance
- Easier setup

Tips for using network adapters

- Make sure the adapter connections are secure.
- Make sure the computer is turned on.
- Make sure you entered the correct IP address.

Advanced wireless setup

Creating an ad hoc wireless network using Windows

The recommended way to set up your wireless network is to use a wireless access point (wireless router). A network set up this way is called an *infrastructure network*. If you have an infrastructure network in your home, you should configure your printer for use on that network.

If you don't have a wireless access point (wireless router) or would like to set up a standalone network between your printer and a computer with a wireless network adapter, you can set up an *ad hoc network*.

For Windows Vista users

- 1 Click  → **Control Panel** → **Network and Internet**.
- 2 Under Network and Sharing Center, click **Connect to a Network**.
- 3 In the Connect to a Network dialog, click **Set up a wireless ad-hoc (computer-to-computer) network**, and then click **Next**.

- 4 Follow the instructions in the “Set up a wireless ad hoc network” wizard. As part of the setup:
 - a Create a network name or SSID for the network between the computer and your printer.
 - b Write the name of your network in the space provided. Be sure to use the exact spelling and capitalization.
 - c Go to the Security Type drop-down, choose WEP, and create a security key (or password).
Note: WEP passwords must be either 5 or 13 characters.
 - d Write the password for your network in the space provided. Be sure to use the exact spelling and capitalization.

Windows Vista will enable the ad hoc network for you. It will appear in the “Connect to a network” dialog under available networks, indicating that the computer is configured for the ad hoc network.

- 5 Close the Control Panel and any remaining windows.
- 6 Insert the printer CD into the computer and follow the direction for wireless installation.
- 7 When the available networks are displayed, provide the network name and the security information you created in step 4. The installer will configure the printer for use with the computer.
- 8 Store a copy of your network name and security information in a safe place for future reference.

For Windows XP users

- 1 Click **Start → Settings → Control Panel → Network Connections**.
- 2 Right-click **Wireless Network Connections**.
- 3 If **Enable** appears in the pop-up menu, click it.
Note: If Enable does not appear, your wireless connection is already enabled.
- 4 Right-click the **Wireless Network Connection** icon.
- 5 Click **Properties**.
- 6 Click the **Wireless Networks** tab.
Note: If the Wireless Networks tab does not appear, your computer has third-party software that controls your wireless settings. You must use that software to set up the ad hoc wireless network. For more information, see the documentation for that software to learn how to create an ad hoc network.
- 7 Select the **Use Windows to configure my wireless network settings** check box.
- 8 Under Preferred Networks, delete any existing networks.
 - a Click the network to be removed.
 - b Click the **Remove** button.
- 9 Click **Add** to create an ad hoc network.
- 10 In the **Network Name (SSID)** box, type the name you want to give your wireless network.
- 11 Write down the network name you chose so you can refer to it when running the wireless setup. Make sure you copy it down exactly, including capital letters.
- 12 If **Network Authentication** appears in the list, select **Open**.
- 13 In the **Data encryption** list, select **WEP**.
- 14 If necessary, deselect the **The key is provided for me automatically** check box.
- 15 In the **Network Key** box, type in a security code.

16 Write down the security code you chose so you can refer to it when running the wireless setup. Make sure you copy it down exactly, including any capital letters.

Note: For more information about passwords (security keys), see “Check your security keys” in the “Wireless troubleshooting” section of the “Troubleshooting” chapter.

17 Type the same security code in the **Confirm network key** box.

18 Select the **This is a computer-to-computer (ad hoc) network; wireless access points are not used.** check box.

19 Click **OK** twice to close the two open windows.

20 It may take a few minutes for your computer to recognize the new settings. To check on the status of your network:

a Right-click the **Wireless Network Connections** icon.

b Select **View Available Wireless Networks**.

- If the network is listed but the computer is not connected, select the ad hoc network and then click the **Connect** button.
- If the network does not appear, wait a minute and then click the **Refresh network list** button.

21 Click **Start → Programs** or **All Programs → Lexmark 6500 Series**.

22 Click **Wireless Setup Utility**.

Note: You may be prompted to connect the printer to the computer again using the installation cable as part of the setup process.

23 Follow the prompts on the computer screen.

24 Store your network name and security code in a safe place for future reference.

Adding a printer to an existing ad hoc wireless network using Windows

1 Click **Start → Programs** or **All Programs → Lexmark 6500 Series**.

2 Click **Wireless Setup**.

3 Follow the instructions on the computer screen.

Loading paper and original documents

Loading paper

1 Make sure:

- You use paper designed for inkjet printers.
- If you are using photo, glossy, or heavyweight matte paper, you load it with the glossy or printable side facing you. (If you are not sure which side is the printable side, see the instructions that came with the paper.)
- The paper is not used or damaged.
- If you are using specialty paper, you follow the instructions that came with it.
- You do not force paper into the printer.

2 Before loading paper the first time, slide the paper guides out toward the edges of the paper support. You can load up to:

- 100 sheets of plain paper
- 25 sheets of heavyweight matte paper
- 25 sheets of photo paper
- 25 sheets of glossy paper

Note: Photos require more drying time. Remove each photo as it exits, and allow it to dry to avoid ink smudging.

3 Load the paper vertically in the center of the paper support, and adjust the paper guides to rest against the edges of the paper.

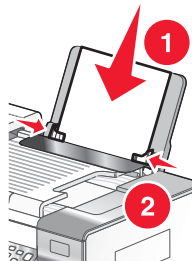

Note: To avoid paper jams, make sure the paper does not buckle when you adjust the paper guides.

Using the automatic paper type sensor

The printer is equipped with an automatic paper type sensing device. The Paper Type Sensor automatically detects the type of paper that has been loaded into the printer and adjusts the settings for you. For example, if you want to print a photo, load photo paper into the printer. The printer detects the type of paper and automatically adjusts the settings to give you optimum photo-printing results.

Loading envelopes

You can load up to 10 envelopes at a time.

Warning: Do not use envelopes that have metal clasps, string ties, or metal folding bars.

- 1 Load envelopes in the center of the paper support with the stamp location in the upper left corner.
- 2 Make sure:
 - The print side of the envelopes faces you.
 - The envelopes are designed for use with inkjet printers.
 - The paper guides rest against the edges of the envelopes.

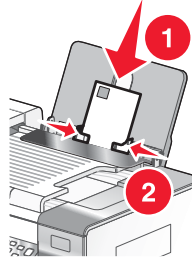

Notes:

- Do not load envelopes with holes, perforations, cutouts, or deep embossing.
- Do not use envelopes that have exposed flap adhesive.
- Envelopes require more drying time. Remove each envelope as it exits, and allow it to dry to avoid ink smudging.

Loading labels

You can load up to 25 sheets of labels at a time.

- 1 Load labels with the print side facing you and the top of the sheet fed into the printer first.
- 2 Make sure:
 - The print side of the labels faces you.
 - The top of the labels feeds into the printer first.
 - The adhesive on the labels does not extend to within 1 mm of the edge of the labels.
 - You use full label sheets. Partial sheets (with areas exposed by missing labels) may cause labels to peel off during printing, resulting in a paper jam.
 - The labels are loaded in the center of the paper support.
 - The paper guides rest against the edges of the labels.

Note: Labels require more drying time. Remove each sheet of labels as it exits, and allow it to dry to avoid ink smudging.

Loading greeting cards, index cards, photo cards, and postcards

You can load up to 25 greeting cards, index cards, photo cards, or postcards at a time.

- 1 Load cards with the print side facing you.
- 2 Make sure:
 - The cards are loaded in the center of the paper support.
 - The paper guides rest against the edges of the cards.

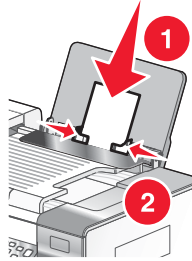

Note: Photo cards require more drying time. Remove each photo card as it exits, and allow it to dry to avoid ink smudging.

Loading transparencies

You can load up to 50 transparencies at a time.

- 1 Load transparencies with the rough side facing you. If the transparencies have a removable strip, each strip should face away from you and down toward the printer.
- 2 Make sure:
 - The transparencies are loaded in the center of the paper support.
 - The paper guides rest against the edges of the transparencies.

Notes:

- Transparencies with paper backing sheets are not recommended.
- Transparencies require more drying time. Remove each transparency as it exits, and allow it to dry to avoid ink smudging.

Loading iron-on transfers

You can load up to 10 iron-on transfers at once, but you will achieve best results loading them one at a time.

- 1 Load iron-on transfers with the print side of the transfer facing you.
- 2 Make sure:
 - You follow the loading instructions that came with the iron-on transfers.
 - The transfers are loaded in the center of the paper support.
 - The paper guides rest against the edges of the transfers.

Loading custom-size paper

You can load up to 100 sheets of custom-size paper at a time.

- 1 Load paper with the print side facing you.
- 2 Make sure:
 - The paper size fits within these dimensions:
Width:
 - 76.0–216.0 mm
 - 3.0–8.5 inchesLength:
 - 127.0–432.0 mm
 - 5.0–17.0 inches
 - The stack height does not exceed 10 mm.
 - The paper is loaded in the center of the paper support.
 - The paper guides rest against the edges of the paper.

Loading banner paper

You can load up to 20 sheets of banner paper at a time.

- 1 Remove all paper from the paper support before loading the banner paper.
- 2 Tear off only the number of pages needed to print the banner.
- 3 Place the required stack of banner paper on the top cover.
- 4 Feed the leading edge of the banner paper into the printer first.

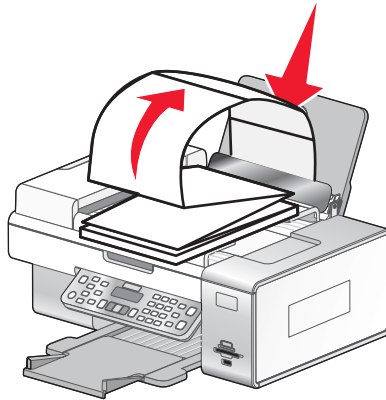

- 5 Make sure:
 - The paper is loaded in the center of the paper support.
 - The paper guides rest against the edges of the paper.

Loading original documents on the scanner glass

You can scan and then print photos, text documents, magazine articles, newspapers, and other publications. You can scan a document for faxing.

Note: The maximum scan area for the scanner glass is 216 x 297 mm (8.5 x 11.7 in.).

1 Open the top cover.

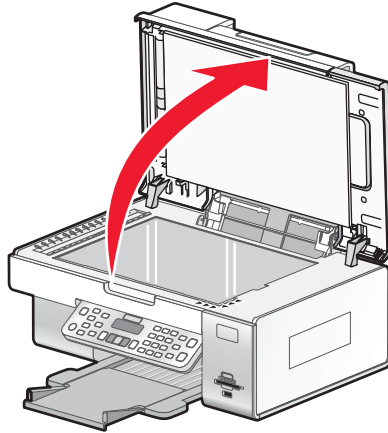

2 Place the original document or item facedown on the scanner glass in the lower right corner.

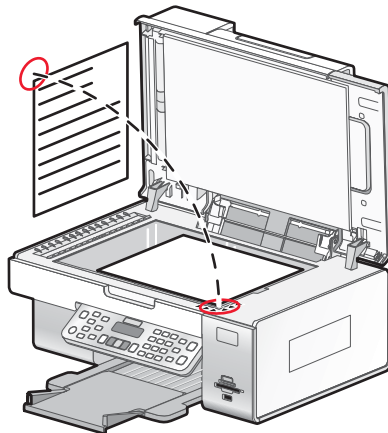

Note: Photos should be loaded as shown.

3 Close the top cover to avoid dark edges on the scanned image.

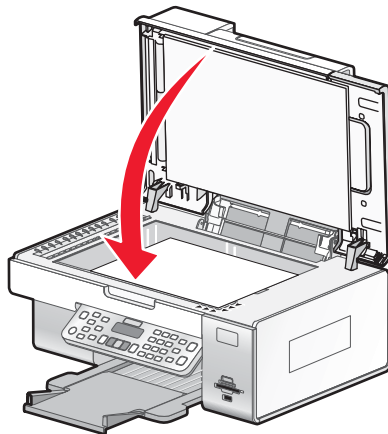

Loading original documents into the Automatic Document Feeder

You can load up to 25 sheets of an original document into the Automatic Document Feeder tray for scanning, copying, and faxing. You can load A4, letter, or legal size paper into the Automatic Document Feeder.

- 1 Load an original document text side up into the Automatic Document Feeder tray.

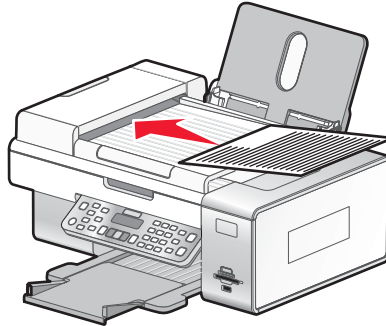

Note: Do not load postcards, photos, small items, or thin media (such as magazine clippings) into the Automatic Document Feeder. Place these items on the scanner glass.

- 2 Adjust the paper guide on the Automatic Document Feeder tray against the edges of the paper.

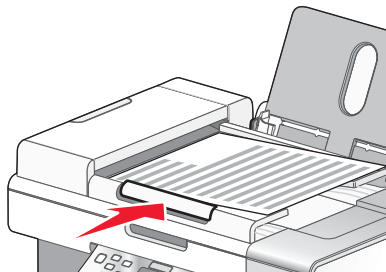

Automatic Document Feeder paper capacity

Load up to	Make sure
25 sheets of: <ul style="list-style-type: none">• Letter paper• A4 paper• Legal-size paper	<ul style="list-style-type: none">• The document is loaded text side up.• The paper guide is against the edge of the paper.

Load up to	Make sure
<p>25 sheets of:</p> <ul style="list-style-type: none"> • Custom paper • Pre-punched paper • Reinforced edge copier paper • Preprinted forms • Letterhead paper 	<ul style="list-style-type: none"> • The document is loaded text side up. • The paper guide is against the edge of the paper. • The paper size fits within these dimensions: <ul style="list-style-type: none"> Width: <ul style="list-style-type: none"> – 210.0 mm–215.9 mm – 8.27 in.–8.5 in. Length: <ul style="list-style-type: none"> – 279.4 mm–355.6 mm – 11.0 in.–14.0 in. • You allow preprinted media to dry thoroughly before loading into the Automatic Document Feeder tray. • You do <i>not</i> use media printed with metallic ink particles. • You avoid embossed designs.

Printing

Printing basic documents

Printing a document

- 1 Load paper.
- 2 With a document open, click **File → Print**.
- 3 Click **Properties, Preferences, Options, or Setup**.
- 4 Adjust the settings.
- 5 Click **OK**.
- 6 Click **OK** or **Print**.

Printing a Web page

You can use the Toolbar to create a printer-friendly version of any Web page.

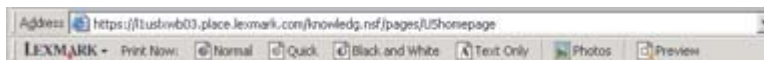

- 1 Load paper.
- 2 Open a Web page using Microsoft Internet Explorer 5.5 or later.
- 3 If you want to check or change your print settings:
 - a From the toolbar area, click **Lexmark → Page Setup**.
 - b Adjust the print settings.
 - c Click **OK**.
- 4 If you want to view the Web page before printing:
 - a Click **Preview**.
 - b Use the toolbar options to scroll between pages, zoom in or out, or select whether to print text and images or text only.
 - c Click:
 - **Print** in the Print Preview window, then click **Print** in the Print dialog that opens
or
 - **Close**, and continue to the next step.
- 5 If needed, select a print option from the Toolbar:
 - **Normal**
 - **Quick**
 - **Black and White**
 - **Text Only**

Printing photos or images from a Web page

- 1 Load paper. For best results, use photo or heavyweight matte paper, with the glossy or printable side facing you. (If you are not sure which side is the printable side, see the instructions that came with the paper.)
- 2 Open a Web page with Microsoft Internet Explorer 5.5 or later.
On the Toolbar, the number of photos valid for printing appears next to Photos.



- 3 If no number appears next to Photos:
 - a From the Lexmark logo drop-down menu, select **Options**.
 - b Select the **Advanced** tab.
 - c Select a lower minimum photo size.
 - d Click **OK**.
The number of photos valid for printing appears next to Photos.
- 4 Click **Photos**.
The Fast Pics dialog appears.
- 5 If you want to print all the photos or images using the same settings, select the size you want, the blank paper size in the printer, and the number of copies.
- 6 If you want to print one photo or image at a time:
 - a Click the photos or images you do *not* want to print to deselect them.
 - b To make common editing changes:
 - 1 Right click the photo or image.
 - 2 Click **Edit**.
 - 3 Make your selections.
 - 4 Follow the instructions on the screen.
 - 5 When you are finished making changes, click **Done**.
 - 6 Select the size you want, the blank paper size in the printer, and the number of copies.
- 7 Click **Print Now**.

Printing multiple copies of a document

- 1 With a document open, click **File → Print** or **Printer Setup**.
- 2 From the Print Setup dialog box, click **Properties**, **Preferences**, **Options**, or **Setup**.
- 3 In the Copies section of the **Quality/Copies** tab, enter the number of copies you want to print.
Note: If you print multiple copies of a multiple-page document and want them collated, click **Collate Copies**.
- 4 Click **OK** to close any printer software dialog boxes that are open.
- 5 Print the document.

Collating copies

If you print multiple copies of a document, you can choose to print each copy as a set (collated) or to print the copies as groups of pages (not collated).

Collated



Not collated



- 1 With a document open, click **File → Print**.
- 2 Click **Properties, Preferences, Options, or Setup**.
- 3 Click the **Quality/Copies** tab.
- 4 From the Multiple Copies section, click **Collate Copies**.
- 5 Click **OK** to close any printer software dialog boxes that are open.
- 6 Print the document.

Notes:

- This option is available only when you are printing multiple copies.
- If printing photos, to prevent smudging, remove each photo as it exits the printer, and let it dry before stacking.

Printing the last page first (reverse page order)

- 1 With a document open, click **File → Print**.
- 2 Click **Properties, Preferences, Options, or Setup**.
- 3 From the **Quality/Copies** tab, select **Print Last Page First**.
- 4 Click **OK**.
- 5 Click **OK** or **Print**.

Printing multiple pages on one sheet (N-Up)

- 1 With a document open, click **File → Print**.
- 2 Click **Properties, Preferences, Options, or Setup**.
- 3 From the **Print Layout** tab, select **N-up**.
- 4 Select the number of pages to print on each page.
- 5 If you want each page image to be surrounded by a border, select **Print Page Borders**.
- 6 Click **OK**.
- 7 Click **OK** or **Print**.

Printing document files from a memory card or flash drive

To print document files, the printer must be connected to a computer, and both the printer and computer must be on. Also, the computer must contain applications that support the file formats of the documents you want to print.

- 1 Insert a memory card into a card slot or a flash drive into the PictBridge port on the front of the printer.

If there are only document files stored on the memory card or flash drive, the printer automatically switches to **File Print** mode.

The following document file types are recognized:

- .doc (Microsoft Word)
- .xls (Microsoft Excel)
- .ppt (Microsoft Powerpoint)
- .pdf (Adobe Portable Document Format)
- .rtf (Rich Text Format)
- .docx (Microsoft Word Open Document Format)
- .xlsx (Microsoft Excel Open Document Format)
- .pptx (Microsoft Powerpoint Open Document Format)
- .wps (Microsoft Works)
- .wpd (WordPerfect)

Note: If there are also photos stored on the memory card or flash drive, the message **Which would you like to print?** appears on the display.

a If necessary, press ◀ or ▶ repeatedly until **Documents** appears.

b Press ✓.

2 If the document you want to print is in a subfolder within the memory card or flash drive, press ✓ repeatedly until the folder you want appears.

Note: Press ↶ to return to the previous folder.

3 Press ◀ or ▶ repeatedly until the file name of the document you want to print appears.

4 Press **Start Color** or **Start Black** to begin printing.

Pausing print jobs

1 For Windows Vista, click  → **Control Panel** → **Printer**.

For Windows XP, click **Start** → **Settings** → **Printers and Faxes**.

2 Right-click the **Lexmark 6500 Series** icon.

3 Select **Pause**.

Canceling print jobs

1 In Windows Vista, click  → **Control Panel** → **Printer**.

In Windows XP, click **Start** → **Settings** → **Printers and Faxes**.

2 Right-click the **Lexmark 6500 Series** icon.

3 Select **Open**.

4 Right-click the document name.

5 Select **Cancel**.

Printing specialty documents

Choosing compatible specialty paper types

- **Heavyweight matte paper**—A photo paper with a matte finish used for printing high-quality graphics.
- **Lexmark PerfectFinish™ Photo paper**—A high-quality photo paper specifically designed for Lexmark inkjet printers, but compatible with all inkjet printers. It is used specifically for printing professional quality photos with a glossy finish. It is best when used with genuine Lexmark evercolor™ 2 ink, providing photos that are fade- and water-resistant.
- **Lexmark Photo Paper**—An outstanding "everyday" heavyweight inkjet photo paper designed for use with Lexmark printers, but compatible with all brands of inkjet printers. Although inexpensive, it offers excellent image quality and outstanding value.
- **Transparency**—A clear, plastic media primarily used for overhead projectors.
- **Card stock**—A very thick paper used for printing sturdier items, such as greeting cards.
- **Iron-On transfer**—A type of media that has a reverse image printed on it that can be ironed onto fabric.

Printing envelopes

- 1 Load envelopes.
- 2 With a document open, click **File → Print**.
- 3 Click **Properties, Preferences, Options, or Setup**.
- 4 From the "I Want To" menu, select **Print on an envelope**.
- 5 From the Envelope Size list, select the envelope size loaded.
- 6 Select **Portrait** or **Landscape** orientation.

Notes:

- Most envelopes use landscape orientation.
- Make sure the same orientation is also selected in the software application.

- 7 Click **OK** to close any printer software dialogs that are open.
- 8 Click **OK** or **Print**.

Printing greeting cards, index cards, photo cards, and postcards

- 1 Load greeting cards, index cards, photo cards, or postcards.
- 2 With a document open, click **File → Print**.
- 3 Click **Properties, Preferences, Options, or Setup**.
- 4 Select a Quality/Speed setting.
Select **Photo** for photos and greeting cards, and select **Normal** for other types of cards.
- 5 Select the **Paper Setup** tab.
- 6 Select **Paper**.
- 7 From the Paper Size list, select a card size.
- 8 Click **OK**.
- 9 Click **OK** or **Print**.

Notes:

- To avoid paper jams, do not force the cards into the printer.
- To prevent smudging, remove each card as it exits, and let it dry before stacking.

Printing a document as a poster

- 1 With a document open, click **File → Print**.
- 2 Click **Properties, Preferences, Options, or Setup**.
- 3 Click the **Print Layout** tab.
- 4 From the **Layout** drop-down box, select **Poster**.
- 5 Select the poster size you want to print. The number you select represents the number of pages that make up the height and width of the poster.
- 6 Select **Print Crop Marks** if you want each page of the poster to show crop marks.
- 7 Click **Select Pages To Print** to reprint any damaged poster pages without having to print all of the poster pages. Click pages to select or cancel them.
- 8 Click **OK** to close any printer software dialogs that are open.
- 9 Print the document.

Note: Certain programs may cause text to be clipped or to disappear when using extra-large or extra-small fonts. If this occurs, try decreasing or increasing the font size.

Printing an image as a poster

- 1 From the desktop, double-click the **Productivity Studio** icon.
- 2 From the Photo Printing area of the Welcome Screen, click **Poster**.
- 3 If you are scanning a photo:
 - a Place the photo facedown on the scanner glass.
 - b Click **File → Add Photo from Scanner**.
- 4 If you are not scanning a new item, open the folder that contains the photo you want to print as a poster.
- 5 Drag the photo to the Print a Multi-Page Poster preview area of the screen.
- 6 Click **Next Step**.
- 7 From the “Paper size to print poster on” drop-down list, select a paper size.
- 8 From the “Paper type to print poster on” drop-down list, select a paper type.
- 9 From the “Print quality for poster” drop-down list, select a print quality.
- 10 From the “Poster size” drop-down list, select the poster size.
- 11 If you want to rotate the poster so that it fits better on the printed pages, click **Rotate 90 degrees**.
- 12 Click **Print Now**.

Printing a booklet

- 1 Before you change any Print Properties settings, you must select the correct paper size from the program. You can print booklets using these paper sizes:
 - Letter
 - A4
 - 2 Load the paper.
 - 3 With a document open, click **File → Print**.
 - 4 Click **Properties, Preferences, Options, or Setup**.
 - 5 Click the **Print Layout** tab, and then click **Booklet**.
 - 6 If you are printing a large booklet, select a number of **Printed sheets per bundle**.
 - a Click **Options → Layout Options**.
 - b From the **Printed sheets per bundle** drop-down menu, select a number of printed sheets per bundle.
- Note:** A bundle is a set number of sheets of paper folded together. The printed bundles are stacked, one on top of the other, keeping the correct page order. The stacked bundles can be bound to make a booklet. When printing with a heavier paper stock, select a smaller number of **Printed sheets per bundle**.
- 7 Click **OK** to close any printer software dialog boxes that are open.
 - 8 Print the document.

Assembling a booklet

- 1 Flip the printed stack of papers over in the paper exit tray.
- 2 Take the first bundle from the stack, fold it in half, and then set it aside with the front page down.
- 3 Take the next bundle from the stack, fold it in half, and then stack it with the front page down on top of the first bundle.



- 4 Stack the rest of the bundles with the front page down, one on top of the other, until the booklet is complete.
- 5 Bind the bundles together to complete the booklet.



Printing on custom-size paper

- 1 Load up to 100 sheets of custom-size paper.
- 2 With a document open, click **File → Print**.
- 3 From the Quality/Copies tab, select a Quality/Speed setting.
- 4 Click the **Paper Setup** tab.
- 5 From the Paper Size section, select **Paper** and then select **Custom Size**.

- 6 Select the measurement units to use.
- 7 Use the sliders, or type the size of the paper loaded into the printer.
- 8 Click **OK** to close any printer software dialogs that are open.
- 9 Print the document.

Note: Do not force paper into the printer.

Printing iron-on transfers

- 1 Load up to 10 iron-on transfers.
- 2 With an image open, click **File → Print**.
- 3 Click **Properties, Preferences, Options, or Setup**.
- 4 From the Print Layout tab, select **Mirror** if you want the printer software to flip the image.
Select **Normal** if you have a program that automatically flips the image.
- 5 Click **OK** to close any printer software dialogs that are open.
- 6 Print the iron-on transfers.

Note: Do not force iron-on transfers into the printer.

Printing transparencies

- 1 Load up to 50 transparencies.
- 2 With a document open, click **File → Print**.
- 3 Click **OK** or **Print**.

Note: To prevent smudging, remove each transparency as it exits, and let it dry before stacking. Transparencies may require up to 15 minutes to dry.

Printing a banner

- 1 With a document open, click **File → Print**.
- 2 Click **Properties, Preferences, Options, or Setup**.
- 3 From the Print Layout tab, select **Banner**.
Note: After you print a banner, return the setting to **Normal**.
- 4 To keep banner paper from jamming, select **Letter Banner** or **A4 Banner** from the Banner Paper Size dialog.
- 5 From the Paper Setup tab, select **Landscape** orientation.
- 6 Click **OK**.
- 7 Click **OK** or **Print**.

Printing on both sides of the paper (duplexing)

Understanding the two-sided printing (duplexing) function

The printer has a built-in duplex unit that lets you print on both sides of the paper automatically. This function is also known as two-sided printing or duplexing.











Note: Automatic two-sided printing (duplexing) works only with plain paper in letter and A4 sizes. If you want to print two-sided documents on another size or type of paper, use the manual duplexing method.

To print a two-sided copy, the  light must be on. The  button works in tandem with the Duplexing settings in the printer software. To access the Duplexing settings:

- 1 With a document open, click **File → Print**.
- 2 Click **Properties, Preferences, Options, or Setup**.
- 3 Click the **Print Layout** tab.

The Duplexing area is on the lower portion of the dialog.

The options under the Duplexing drop-down box are “Use Printer Settings,” “On,” “Off,” and “Manual.”



Select	To
Use Printer Settings	Control two-sided printing using the  button. Press  to turn the  light on or off. <ul style="list-style-type: none"> • When the  light is on, your documents are printed on both sides of the paper (duplexed). • When the  light is off, your documents are <i>not</i> printed on both sides of the paper. Note: Use Printer Settings is the factory default setting.
On	Turn on the  button so that <i>all</i> documents are printed on both sides of the paper. Note: The  light stays on until you select a different option.
Off	Turn off the  button so that all documents are printed on one side of the paper. Note: The  light stays off until you select a different option.
Manual	Duplex a print job manually. You must select this option when printing two-sided jobs that will be printed on a size or type of paper other than letter- or A4-size plain paper (such as greeting cards). Note: You can select to print the two-sided pages so they turn like the pages of a magazine <div style="display: flex; justify-content: space-around; align-items: center; margin-top: 10px;"> <div style="text-align: center;">  <p>(Side-Flip) or like the pages of a legal pad (Side-Flip is the factory default setting.</p> </div> <div style="text-align: center;">  <p>Top-Flip).</p> </div> </div>

For more information, see “Printing on both sides of the paper (duplexing) automatically” on page 75 and “Printing on both sides of the paper (duplexing) manually” on page 76.

Printing on both sides of the paper (duplexing) automatically

The printer has a built-in duplex unit that lets you print on both sides of the paper automatically.

Note: Automatic two-sided printing (duplexing) works only with plain paper in letter and A4 sizes. If you want to print two-sided documents on another type or size of paper, use the manual duplexing method.

- 1 Press .
- 2 With a document open, click **File → Print**.
- 3 Click **Properties, Preferences, Options, or Setup**.
- 4 Click the **Print Layout** tab
- 5 From the Duplexing area, select **Use Printer Settings** from the drop-down box.
- 6 Make sure the  light is on.
- 7 Click **OK** to close any printer software dialogs that are open.
- 8 Press .

Note: To return to single-sided printing, make sure the  light is not on.

Printing on both sides of the paper (duplexing) manually

If you want to print a two-sided (duplex) document on a size or type of paper other than plain letter- or A4-size paper, you must use the manual duplex method. This method involves printing the odd-numbered pages, then flipping and reloading the stack of paper to print the even-numbered pages on the other side of the sheets.

- 1 With a document open, click **File → Print**.
- 2 Click **Properties, Preferences, Options or Setup**.
- 3 Click the **Print Layout** tab.
- 4 From the Duplexing area, select **Manual** from the drop-down box.
- 5 Select the **Print manual duplex instructions** check box.
- 6 Press .
- 7 The printer prints the odd-numbered pages and the instruction sheet, which describes how to flip and reload the paper.
- 8 Following the instruction sheet, flip and reload the paper with the printed side facing away from you.
- 9 The printer then prints the even-numbered pages on the reverse sides of the odd-numbered pages, completing the two-sided sheets.

Note: If you want to return to automatic duplexing, go to the Duplexing drop-down box and select **Use Printer Settings**.

Changing printer settings

Saving and deleting print settings

- 1 With a document open, click **File → Print**.
- 2 Click **Properties, Preferences, Options, or Setup**.
- 3 Click the **Quality/Copies** tab.
- 4 Make necessary adjustments to any of the settings in the Quality/Speed, Paper Type, and Multiple Copies sections.

- 5 From the Save Settings drop-down menu, select **Save your current settings**.
- 6 Click a radio button next to the number of the location where you want to save your settings, then type a name for your settings in the selected box.
Note: The first location contains Factory Default Settings, which cannot be changed or deleted.
- 7 Click **Save**.

Notes:

- To retrieve your print settings, click the **Save Settings** drop-down menu, and select them from the list.
- To delete settings, choose **Delete a setting from the list** from the Save Settings drop-down menu. Select the radio button next to the setting you want to delete, and then click **Delete**.

Resetting printer software to factory default settings

Windows 2000, Windows XP, or Windows Vista users

- 1 In Windows Vista, click  → **Control Panel** → **Printer**.
In Windows 2000 and Windows XP, click **Start** → **Settings** → **Printers** or **Printers and Faxes**.
- 2 Right-click the **Lexmark 6500 Series** icon.
- 3 Click **Printing Preferences**.
- 4 Click the **Save Settings** menu.
- 5 From the Restore section, select **Factory Settings (Defaults)**.

Note: Factory default settings cannot be deleted.

Working with photos

Retrieving and managing photos

Inserting a memory card

- 1 Insert a memory card.
 - Insert the card with the brand name label facing up.
 - If there is an arrow on the card, make sure it points toward the printer.
 - Make sure you connect the memory card to the adapter that came with it before inserting it into the slot.

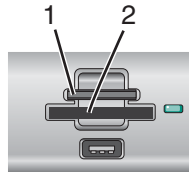

Slots	Memory card
1	<ul style="list-style-type: none">• xD-Picture Card• xD-Picture Card (type H)• xD-Picture Card (type M)• Secure Digital• Mini Secure Digital (with adapter)• Micro Secure Digital (with adapter)• MultiMedia Card• Reduced Size MultiMedia Card (with adapter)• MultiMedia Card mobile (with adapter)• Memory Stick• Memory Stick PRO• Memory Stick Duo (with adapter) or Memory Stick PRO Duo (with adapter)
2	<ul style="list-style-type: none">• Compact Flash Type I and Type II• Microdrive

- 2 Wait for the light located near the memory card slots on the printer to come on. The light blinks to indicate the memory card is being read or is transmitting data.

Warning: Do not touch cables, any network adapter, the memory card, or the printer in the area shown while actively printing, reading, or writing from a memory card. A loss of data can occur. Also, do not remove a memory card while actively printing, reading, or writing from a memory card.



When the printer recognizes that a memory card is installed, the message **Memory Card Detected** appears.

If the printer does not read the memory card, remove and reinsert it. For more information, see “Memory card troubleshooting” on page 176.

Notes:

- The printer recognizes one active media device at a time.
- If you insert more than one memory card, a message appears on the display prompting you to remove all memory cards inserted. After removing all the memory cards from the printer, re-insert the memory card that you want to use.
- If you insert a memory card and a flash drive is already inserted into the printer, a message appears on the display prompting you to designate the device you want the printer to recognize.

Inserting a flash drive

- 1 Insert the flash drive into the PictBridge port on the front of the printer.

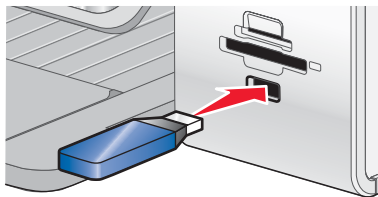

Note: An adapter may be necessary if your flash drive does not fit directly into the port.

- 2 Wait for the printer to recognize that a flash drive is installed. When the flash drive is recognized, the message **Storage Device Detected** appears.

If the printer does not read the flash drive, remove and reinsert it.

Warning: Do not touch cables, any network adapter, the flash drive, or the printer in the area shown while actively printing, reading, or writing from the flash drive. A loss of data can occur. Also, do not remove the flash drive while actively printing, reading, or writing from the flash drive.



Note: The printer recognizes one active media device at a time. If you insert more than one media device, a message appears on the display prompting you to designate the device you want the printer to recognize.

Understanding the Photo Card menu

- 1 If necessary, press **Photo Card**, or insert a memory card or a flash drive into the printer.
- 2 Press ◀ or ▶ repeatedly until the menu item you want appears, and then press ✓.
- 3 Press ◀ or ▶ repeatedly until the submenu item you want or the setting you want appears, and then press ✓.
Note: Pressing ✓ selects a setting. An * appears next to the selected setting.
- 4 To go into additional submenus and settings, repeat steps 2 and 3 as needed.
- 5 If necessary, press ↶ repeatedly to return to the previous menus and make other setting selections.
- 6 Press **Start Color** or **Start Black**.

Menu item	Action
Proof Sheet	Print and then scan a proof sheet: <ul style="list-style-type: none"> • for all photos on the memory card • for the most recent 20 photos • by date
Print Photos	Print photos directly from a memory card or flash drive.
Save Photos	<ul style="list-style-type: none"> • Save photos stored on a memory card or flash drive to the computer. • Copy photos from a memory card to a flash drive.
Lighter/Darker	Adjust brightness of printed photos.
Photo Effects ¹	Apply automatic image enhancement or color effects to your photos.
Paper Setup ^{1, 2}	Specify the size and type of the paper loaded.
Photo Size ^{1, 2}	Specify the size photo you want.
Layout ¹	Select borderless or bordered, center one photo on a page, or specify the number of photos to print on a page.
Quality ¹	Adjust the quality of printed photos.
¹ Setting will return to factory default setting when a memory card or flash drive is removed. ² Setting must be saved individually.	

Saving Paper Size, Paper Type, and Photo Size settings

- 1 From the control panel, press **Settings**.
- 2 Press ◀ or ▶ repeatedly until **Paper Setup** appears.
- 3 Press ✓.
- 4 Press ◀ or ▶ repeatedly until **Paper Size** appears.
- 5 Press ✓.

- 6 Press ◀ or ▶ repeatedly until the size you want appears.
- 7 Press ✓.
- 8 Press ↻ to go to the **Paper Type** submenu.
- 9 Press ✓.
- 10 Press ◀ or ▶ repeatedly until the setting type you want appears.
- 11 Press ✓.
- 12 Press ↻ repeatedly until **Defaults** appears.
- 13 Press ✓.
- 14 Press ◀ or ▶ repeatedly until **Photo Print Size** appears.
- 15 Press ✓.
- 16 Press ◀ or ▶ repeatedly until the setting you want appears.
- 17 Press ✓.

Connecting a PictBridge-enabled digital camera

PictBridge is a technology available in most digital cameras that lets you print directly from your digital camera without using a computer. You can connect a PictBridge-enabled digital camera to the printer, and use the camera to control printing photos.

- 1 Insert one end of the USB cable into the camera.
Note: Use only the USB cable that came with the camera.
- 2 Insert the other end of the cable into the PictBridge port on the front of the printer.

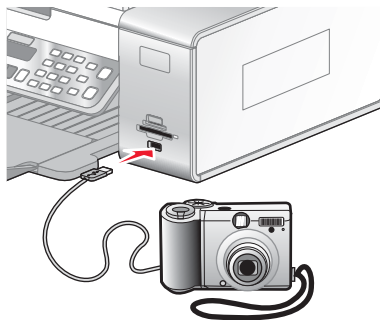

Notes:

- Make sure the PictBridge-enabled digital camera is set to the correct USB mode. If the camera USB selection is incorrect, the camera will be detected as a USB storage device, or an error message will be displayed on the control panel of the printer. For more information, see the documentation that came with your camera.
 - The printer reads only one media device at a time.
- 3 If the PictBridge connection is successful, the following appears on the display: **PictBridge Camera detected. Press ✓ to change the settings.**

Understanding the PictBridge menu

The PictBridge default settings menu lets you select printer settings if you did not specify the settings beforehand on your digital camera. For more information on making camera selections, see the documentation that came with your camera.

- 1 Connect a PictBridge-enabled digital camera to the printer.
 - a Insert one end of the USB cable into the camera.

Note: Use only the USB cable that came with the digital camera.
 - b Insert the other end of the cable into the PictBridge port on the front of the printer.



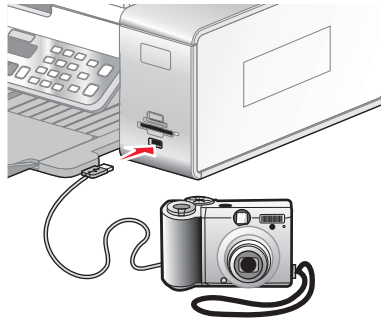





Note: The PictBridge port is marked with the  PictBridge symbol.



The message, **PictBridge camera detected. Press  to change settings.** appears on the display.



Warning: Do not touch the USB cable, any network adapter, or the printer in the area shown while actively printing from a PictBridge-enabled digital camera. A loss of data can occur. Also, do not remove the USB cable or network adapter while actively printing from a PictBridge-enabled digital camera.

- 2 Press  or  repeatedly until the menu item you want appears.
- 3 Press .
- 4 Press  or  repeatedly until the submenu item you want or the setting you want appears.
- 5 Press .
- Note:** Pressing  selects a setting. An * appears next to the selected setting.
- 6 To go into additional submenus and settings, repeat the above steps.
- 7 If necessary, press  repeatedly to return to the previous menus and make other setting selections.

Menu Item	Action
Paper Setup ^{1, 2}	Specify the size and type of paper loaded.
Photo Size ^{1, 2}	Specify the size of printed photos. Note: If you did not specify the photo size beforehand in your digital camera, the default photo sizes are: <ul style="list-style-type: none"> • 4 x 6 (if Letter is your default Paper Size) • 10 x 15 cm (if A4 is your default Paper Size, and your country is <i>not</i> Japan) • L (if A4 is your default Paper Size, and your country is Japan)
Layout ¹	Center one photo on a page, or specify the number of photos to print on a page.
Quality ¹	Adjust the quality of printed photos.
¹ Setting will return to factory default setting when the PictBridge-enabled digital camera is removed. ² Setting must be saved individually.	

Transferring photos from a memory device to the computer using the control panel

If the printer is connected directly to a computer, or connected to a computer through a wireless network connection, you can transfer photos from a memory card or flash drive to the computer.

Note: The printer may require that you select a computer (and a PIN, if required by that computer).

- 1 Insert a memory card or a flash drive that contains the images you want to transfer. For more information, see “Inserting a memory card” on page 78 or “Inserting a flash drive” on page 79.
- 2 Press ◀ or ▶ repeatedly until **Save Photos** appears.
- 3 Press ✓.
- 4 If necessary, press ◀ or ▶ repeatedly until **Computer** appears.
- 5 Press ✓.
- 6 If necessary, press ◀ or ▶ repeatedly until the computer name you want appears.
- 7 If required by the selected computer, type in the four-digit PIN using the keypad.
- 8 Follow the instructions on the computer screen.

Transferring all photos from a memory card using the computer

- 1 Insert a memory card into the printer with the label facing the printer control panel. If the computer is connected to a wireless network, you will need to select the printer.
Note: For a network connection, you must manually open the application and select the printer you want to use. The Productivity Studio software launches automatically on your computer.
- 2 Click **Automatically save all photos to “My Pictures”**.

3 If you want to erase the photos from the memory card, click **Yes**.

Note: Make sure all the photos have been copied before you click **Yes** to erase.

4 Click **Done**. Remove the memory card to view your transferred photos in the Library.

Transferring selected photos from a memory card using the computer

1 Insert a memory card into the printer with the label facing the printer control panel.

The Lexmark Imaging Studio software launches automatically on your computer.

Note: For a wireless network connection, you must first open the application and then select the printer you wish to use.

2 Click **Select photos to save**.

3 Click **Deselect All**.

4 Click to select the photo(s) you want to transfer.

5 Click **Next**.

6 If you want to save the photos to the default folder, click **Next**.

7 If you want to save the photos in a folder other than the default folder:

a Click **Browse**.

b Select the folder you want.

c Click **OK**.

8 If you want to assign a prefix to all of the photos you just transferred, click the check box and enter a name.

9 Click **Next**.

10 If you want to erase the photos from the memory card, click **Yes**.

Note: Make sure all the photos have been copied before you select **Yes** to erase.

11 Click **Done**. Remove the memory card to view your transferred photos in the Photo Library.

Transferring all photos from a CD or flash drive using the computer

1 Insert a CD or a flash drive into the computer.

2 If you are using Windows Vista, an AutoPlay screen appears.

Click **Transfer photos to your computer**.

3 If you are using Windows XP, a “What do you want Windows to do?” screen appears.

Click **Copy pictures to a folder on my computer using Microsoft Scanner and Camera Wizard**.

4 If you are using Windows 2000:

a From the desktop, double-click the **Productivity Studio** icon.

b Click **Transfer Photos**.

5 Click **Automatically save all photos to “My Pictures”**.

6 Remove the flash drive or CD to view your transferred photos in the Library.

Transferring selected photos from a CD or flash drive using the computer

- 1 Insert a CD or a flash drive into the computer.
- 2 If you are using Windows Vista, an “AutoPlay” screen appears.
Click **Transfer Photos to your computer using the Productivity Studio**.
- 3 If you are using Windows XP, a “What do you want Windows to do?” screen appears.
Click **Transfer Photos to your computer using the Productivity Studio**.
If you are using Windows 2000:
 - a From the desktop, double-click the **Productivity Studio** icon.
 - b Click **Transfer Photos**.
- 4 Click **Select photos to save**.
- 5 Click **Deselect All**.
- 6 Click to select the photo(s) you want to transfer.
- 7 If you want to save the photos to the default folder, click **Next**.
- 8 If you want to save the photos in a folder other than the default folder:
 - a Click **Browse**.
 - b Select the folder you want.
 - c Click **OK**.
- 9 If you want to assign a prefix to all of the photos you just transferred, select the check box and enter a name.
- 10 Click **Next**.
- 11 Remove the CD or flash drive to view your transferred photos in the Library.

Transferring photos from a memory card to a flash drive

- 1 Insert a memory card that contains the images you want to transfer. For more information, see “Inserting a memory card” on page 78.
- 2 Insert a flash drive into the PictBridge port on the front of the printer. For more information, see “Inserting a flash drive” on page 79.
Which device is to be displayed? appears on the display.
- 3 Press ◀ or ▶ repeatedly until **Camera Card** or the specific type of your camera card appears.
- 4 Press ✓.
- 5 Press ◀ or ▶ repeatedly until **Save Photos** appears.
- 6 Press ✓.
- 7 If needed, press ◀ or ▶ repeatedly until **USB drive** appears.
- 8 Press ✓.
- 9 If needed, press ◀ or ▶ repeatedly until the setting you want appears.

Notes:

- If photos on the memory card were taken on more than one date, selections will include **Last Date** and **Date Range**.
- To choose a date range, press ✓ and then press ◀ or ▶ repeatedly until the desired date is displayed. Date ranges are displayed by month and year starting with the most recent month.

10 Press **Start Color** or **Start Black**.

Notes:

- If there is not enough memory on the flash drive, a prompt appears on the display.
- Do not remove the flash drive until a message appears on the display indicating that copying is complete.

Warning: Do not touch cables, any network adapter, the memory card or flash drive, or the printer in the area shown while actively printing, reading, or writing from a memory card or flash drive. A loss of data can occur. Also, do not remove a memory card or flash drive while actively printing, reading, or writing from a memory card or flash drive.



Changing the Productivity Studio temporary files preferences

- 1 From the desktop, double-click the **Productivity Studio** icon.
- 2 From the Tools menu, click **Preferences**.
- 3 Click **Temporary Files**.
 - a Use the slider to set the maximum disk space you want to allocate for temporary files created by the Productivity Studio.
 - b Click **Browse** to choose a different folder for saving the temporary files.
- 4 Click **OK**.

Changing the Productivity Studio searched folders preferences

- 1 From the desktop, double-click the **Productivity Studio** icon.
- 2 From the Tools menu, click **Preferences**.
- 3 Click **Searched Folders**.
- 4 If you want to exclude system folders when looking for photos, select **Ignore system folders**.
- 5 Click **OK**.

Changing the Productivity Studio library preferences

- 1 From the desktop, double-click the **Productivity Studio** icon.
- 2 From the Tools menu, click **Preferences**.
- 3 Click **Library**.

From here, you can choose how you want to sort photos. You can also set the minimum file size for the photo to appear in the library.

- 4 Click **OK**.

Changing the Productivity Studio transfer settings

- 1 From the desktop, double-click the **Productivity Studio** icon.
- 2 From the Tools menu, click **Preferences**.
- 3 Click **Transfer Settings**.
 - a Select “**Skip Save option and go automatically to**”, and choose to Automatically Save, Manually Save, or Print your photos from the photo storage device connected to your computer.
 - b Click **Browse** to choose a different folder to transfer your photos to.
 - c Select “**Always erase photos from my media after transferring**” to automatically delete photos from your photo storage device after transferring them to your computer.
- 4 Click **OK**.

Editing photos

Cropping a photo

- 1 From the Productivity Studio Welcome Screen, click **File → Open** to select the image you want to edit.
- 2 With an image open, click **Crop Photo** on the Quick Fixes tab.
- 3 Click and drag with your mouse to select the section of the image that you want to crop. You can adjust the cropped area by using your mouse and dragging the lines to increase or decrease the cropped area.
- 4 Click **Crop Now**.
- 5 The cropped portion of the original image displays in the Preview pane. You can save the cropped image.

Rotating a photo

- 1 From the Productivity Studio Welcome Screen, click **File → Open** to select the image you want to edit.
- 2 With an image open, click the **Quick Fixes** tab.
- 3 Click **Rotate Left** or **Rotate Right** to rotate the image 90 degrees in either direction.

The thumbnail of the photo is updated.

Changing the Resolution / Size of a photo

Resolution refers to dpi (dots per inch).

- 1 From the Productivity Studio Welcome Screen, click **File → Open** to select the image you want to edit.
- 2 With an image open, click **Advanced**.

3 Click **Image Resolution / Size**.

4 Select **Photo Size** to select from a list of defined photo sizes, or click **Custom Size** to enter a different photo size.

Note: If you selected **Photo Size**, you can click **Rotate** to rotate your photo 90 degrees clockwise.

5 If you selected **Custom Size**, enter the width and height for your custom-size photo.

Note: **Maintain Aspect Ratio** is selected by default. This ensures that your image will remain proportional.

Applying One-Click Auto Fixes to a photo

From the Productivity Studio Welcome Screen, click the **Quick Fixes** tab to access all three One-Click Auto Fixes.

1 Click **File → Open** to select the image you want to edit.

2 With an image open, click **One-Click Auto Fix** to let the software automatically adjust the brightness and contrast of your image.

3 Click **Automatic Brightness** to adjust only the brightness of your image.

4 Click **Automatic Red-Eye Reduction** to let the software automatically reduce the appearance of red-eye in your image.

Note: Click **Undo** at the top of the window if you are not satisfied with the results after applying any of the One-Click Auto Fixes.

Reducing the red-eye effect in a photo

1 From the Productivity Studio Welcome Screen, click **File → Open** to select the image you want to edit.

2 With an image open, click the **Quick Fixes** tab.

3 Click **Automatic Red-Eye Reduction** to let the software reduce the red-eye effect automatically. If you are not satisfied with the results, continue with the steps below.

4 Click **Manual Red-Eye Reduction**.

5 Move the cursor across the photo, and place it over an affected eye.

6 Click to reduce the red-eye effect.

Blurring/Sharpening a photo

Increasing the amount of blur will soften your image. Increasing the sharpness will make your image seem more focused.

1 From the Productivity Studio Welcome Screen, click **File → Open** to select the image you want to edit.

2 With an image open, click the **Enhancements** tab.

3 Click **Blur / Sharpen**.

4 Use the slider to blur or sharpen the image. You can preview the changes to the image by comparing the **Before** and **After** preview panes at the top of the window.

5 Click **OK** to accept your changes, or click **Cancel** to reject them.

Enhancing a photo

The Enhance feature lets you make subtle adjustments to the brightness, contrast, and sharpness of an image.

- 1 From the Productivity Studio Welcome Screen, click **File → Open** to select the image you want to edit.
- 2 With an image open, click the **Enhancements** tab.
- 3 Click **Enhance**.
- 4 Use the slider to adjust the Enhance setting. You can preview the changes to your image by comparing the **Before** and **After** preview panes at the top of the window.
Note: Click **Automatic** to let the software automatically enhance your photo.
- 5 Click **OK** to accept your changes, or click **Cancel** to reject them.

Changing the Hue / Saturation of a photo

Adjusting hue lets you control the color of an image. Adjusting its saturation lets you control the intensity of the color.

- 1 From the Productivity Studio Welcome Screen, click **File → Open** to select the image you want to edit.
- 2 With an image open, click the **Enhancements** tab.
- 3 Click **Hue / Saturation**.
- 4 Use the slider to adjust the hue or saturation of your photo. You can preview the changes to the image by comparing the **Before** and **After** preview panes at the top of the window.
- 5 Click **OK** to accept your changes, or click **Cancel** to reject them.

Changing the Gamma Value of a photo or image

Adjusting the gamma value helps you to control the overall brightness of an image—particularly those intended to be viewed on a computer monitor. When images are not properly gamma-corrected, they will look either too light or too dark.

- 1 From the Productivity Studio Welcome Screen, click **File → Open** to select the image you want to edit.
- 2 With an image open, click **Advanced**.
- 3 Type a value in the text box, or use the up or down arrows to select a higher or lower gamma value.
Note: You can enter gamma values from -10–10. If you are not satisfied with your changes, return the gamma value back to 0.
- 4 Click **Save** to keep your changes.

Despeckling a photo

Despeckling lets you remove specks that appear in your photo.

- 1 From the Productivity Studio Welcome Screen, click **File → Open** to select the image you want to edit.
- 2 With an image open, click **Enhancements**.
- 3 Click **Despeckle**.
- 4 Using the slider, adjust the Despeckle setting. You can preview the changes to your image by comparing the **Before** and **After** preview panes at the top of the window.
- 5 Click **OK**. The thumbnail is updated.

Changing the Brightness / Contrast settings of a photo

- 1 From the Productivity Studio Welcome Screen, click **File → Open** to select the image you want to edit.
- 2 With an image open, click **Enhancements**.
- 3 Click **Brightness/Contrast**.
- 4 Adjust the brightness and contrast settings. You can preview the changes to the image by comparing the **Before** and **After** preview panes at the top of the window.
- 5 Click **OK** to accept your changes, or click **Cancel** to reject them.

Note: You can let the software automatically adjust only the brightness of the image by clicking **Automatic Brightness** on the Quick Fixes tab.

Applying a color effect to a photo

- 1 From the Productivity Studio Welcome Screen, click **File → Open** to select the image you want to edit.
- 2 With an image open, click the **Enhancements** tab.
- 3 Click **Color Effects**.
- 4 Apply a color effect.
You can select sepia, antique brown, black and white, or antique grey.
- 5 Click **OK**.

Changing the Exposure setting of a photo

Changing the Exposure setting lets you correct lighting irregularities in your photo.

- 1 From the Productivity Studio Welcome Screen, click **File → Open** to select the image you want to edit.
- 2 With an image open, click **Enhancements**.
- 3 Click **Exposure**.
- 4 Using the slider, adjust the amount of exposure to correct uneven lighting in your image. You can preview the changes to your image by comparing the **Before** and **After** preview panes at the top of the window.
- 5 Click **OK** to accept your changes, or click **Cancel** to reject them.

Removing wavy patterns from scanned photos, magazines, or newspapers

Descreening helps to remove wavy (moire) patterns from images scanned from magazines or newspapers.

- 1 From the Productivity Studio Welcome Screen, click **File → Open** to select the image you want to edit.
- 2 Click the **Advanced** tab.
- 3 Click **Image Patterns**.
- 4 To remove the image patterns caused by scanning from magazines or newspapers, click **Remove Patterns**.
- 5 From the drop-down list, select the patterns to be removed.
- 6 To reduce stray marks on color photos, click the check box, and then move the slider to the desired value.
- 7 Click **OK**. The thumbnail is updated.

Printing photos

Printing photos from a CD or removable storage device using the computer

- 1 Load photo paper with the glossy or printable side facing you. (If you are not sure which side is the printable side, see the instructions that came with the paper.)
- 2 Insert a CD or any removable storage device (such as a flash drive, memory card, or digital camera) into the computer.
 - a If you are using Windows XP or Windows Vista, a “What do you want Windows to do?” screen appears. Click **Transfer Photos to your computer using the Lexmark Imaging Studio**.
 - b If you are using Windows 2000:
 - 1 From the desktop, double-click the **Productivity Studio** icon.
 - 2 Click **Transfer Photos**.
- 3 Click **Select photos to print**.
- 4 To print all photos, click **Print**.
- 5 To print selected photos, click **Deselect All** and select only the photo(s) you want to print.
- 6 Click **Print**.
- 7 From the Quality drop-down list, select a print quality.
- 8 From the Paper Size in the Printer drop-down list, select the paper size.
- 9 To select multiple prints of a photo, or to select photo sizes other than 4 x 6 in. (10 x 15 cm), select the options you want in the table. Use the drop-down list in the last column to view and select other sizes.

Note: If you want to edit your photo(s) before printing, click **Edit Photo** above the Print Preview pane. Select **One-Click Auto Fix**, **Automatic Red-Eye Reduction**, or **Automatic Brightness Fix** to let the software edit your photo(s) automatically. Click **More Retouch Tools** to go to the photo-editing window. When you've completed your edit(s), click **Return with edits** in the bottom right corner to return to the print window.
- 10 Click **Print Now** in the bottom right corner of the window.
- 11 Remove the CD or storage device.

Viewing / Printing photos from the Productivity Studio

- 1 From the desktop, double-click the **Productivity Studio** icon.
- 2 Click **Work with Documents and Photos**.
- 3 Click to select the photo(s) you want to print.
- 4 From the Productivity Studio taskbar located at the bottom of the screen, click **Photo Prints**.
- 5 From the Quality drop-down list, select a copy quality.
- 6 From the Paper Size in Printer drop-down list, select the paper size.
- 7 From the Paper Type in Printer drop-down list, select the paper type
- 8 To select multiple prints of a photo, or to select photo sizes other than 10 x 15 cm (4 x 6 in.), select the options you want in the table. Use the drop-down list in the last column to view and select other sizes.
- 9 Click **Print Now** in the bottom right corner of the screen.

Printing Photo Packages

- 1 From the desktop, double-click the **Productivity Studio** icon.
- 2 Click **Photo Packages**.
- 3 Click to select the photos you want to include in your photo package.
- 4 Click **Next**.
- 5 From the Quality drop-down list, select a copy quality.
- 6 From the Paper Size in Printer drop-down list, select the paper size.
- 7 To select multiple prints of a photo, or to select photo sizes other than 4 x 6 in. (10 x 15 cm), select the options you want in the table. Use the drop-down list in the last column to view and select other sizes.
- 8 Click **Print Now** in the bottom right corner of the screen.

Creating Photo Greeting Cards

- 1 From the desktop, double-click the **Productivity Studio** icon.
- 2 Click **Photo Greeting Cards**.
- 3 From the Style tab, click to select a style for your greeting card.
- 4 From the Photo tab, select and drag a photo into the preview pane on the right side of the screen.
- 5 Click the text area to be able to add text to your photo greeting card.
- 6 When you have finished editing your text, click **OK**.
- 7 If you want to create another photo greeting card using a different style and/or photo, click **Add New Card**, and repeat step 3 on page 92 through step 6 on page 92.
- 8 If you want to print your photo greeting card, select **Print your Photo Greeting Card** from the Share tab.
- 9 Select the number of copies from the Copies drop-down list.
- 10 Select the copy quality from the Quality drop-down list.
- 11 Select the paper size from the Paper Size in Printer drop-down list.

Paper sizes supported	Dimensions
A4	210 x 297 millimeters
Letter	8.5 x 11 inches
Greeting cards	4 x 8 inches (10.16 x 20.32 centimeters)

- 12 Click **Print Now**.
- 13 If you want to e-mail your photo greeting card, click **E-mail your Photo Greeting Card** from the Share tab.
- 14 From the Send Quality and Speed area of the screen, select the image size.
- 15 Click **Create E-mail** to create an e-mail message with your photo greeting card(s) attached.

Printing all photos from a memory device

- 1 Load photo paper with the glossy or printable side facing you. (If you are not sure which side is the printable side, see the instructions that came with the paper.)
- 2 Insert a memory card or flash drive that contains the images you want to print.
- 3 Press ◀ or ▶ repeatedly until **Print Photos** appears.
- 4 Press ✓.
- 5 Press ◀ or ▶ repeatedly until **Print All Photos** appears.
- 6 Press **Start Color** or **Start Black**.

The print settings used on the print job are displayed sequentially on the second line of the display.
- 7 Press **Start Color** or **Start Black** again.

Printing photos stored on the memory device using the proof sheet

- 1 Load plain letter- or A4-size paper.
- 2 Insert a memory card or flash drive that contains the images you want to print.
- 3 Press ◀ or ▶ repeatedly until **Proof Sheet** appears.
- 4 Press ✓.
- 5 Press ◀ or ▶ repeatedly until **Print Proof Sheet** appears.
- 6 Press ✓.
- 7 Press ◀ or ▶ to specify which category of photos you want to print.

You can print a proof sheet:

 - For all photos on the memory card
 - For the 20 most recent photos, if there are 20 or more photos on the card
 - By date, if the photos on the card were taken on more than one date
- 8 Press ✓.
- 9 Press ✓ again.

One or more proof sheets print.
- 10 Follow the instructions on the proof sheet to select which photos to print, the number of copies, red-eye reduction, page layout, print options, color effects, and paper size.

Note: When making selections, make sure you completely fill in the circles.
- 11 Load the proof sheet facedown on the scanner glass.
- 12 If needed, press ◀ or ▶ repeatedly until **Scan Proof Sheet** appears.
- 13 Press ✓.
- 14 Press **Start Color** or **Start Black** to scan the proof sheet.

- 15 Load photo paper with the glossy or printable side facing you. (If you are not sure which side is the printable side, see the instructions that came with the paper.)

Note: Make sure the paper matches the size you selected on the proof sheet.

- 16 Press **Start Color** or **Start Black** to print your photos.

Printing photos by number

You can print photos using the numbers assigned to them on a photo proof sheet. If you want to print photos by photo number, you must first print a proof sheet. For more information, see “Printing photos stored on the memory device using the proof sheet” on page 93.

- 1 Load photo paper with the glossy or printable side facing you. (If you are not sure which side is the printable side, see the instructions that came with the paper.) For more information, see “Loading paper” on page 60.
- 2 Insert a memory card or flash drive that contains the images you want to print. For more information, see “Inserting a memory card” on page 78 or “Inserting a flash drive” on page 79.
- 3 Press ◀ or ▶ repeatedly until **Print Photos** appears.
- 4 Press ✓.
- 5 Press ◀ or ▶ repeatedly until **Photo Number** appears.
- 6 Press ✓.
- 7 Press ◀ or ▶ repeatedly until the photo number you want appears.
- 8 Press ✓ to select a photo.

Note: When you select a photo, an asterisk (*) appears to the left of the number on the second line of the display.

- 9 If you want to select additional photos, press ◀ or ▶ to reach the number, and then press ✓
- 10 Press **Start Color** or **Start Black**.

The print settings used on the print job are displayed one at a time on the second line of the display.

- 11 Press **Start Color** or **Start Black** again.

Using a PictBridge-enabled digital camera to control printing photos

You can connect a PictBridge-enabled digital camera to the printer, and use the buttons on the camera to select and print photos.

- 1 Insert one end of the USB cable into the camera.

Note: Use only the USB cable that came with the digital camera.

- 2 Insert the other end of the cable into the PictBridge port on the front of the printer.

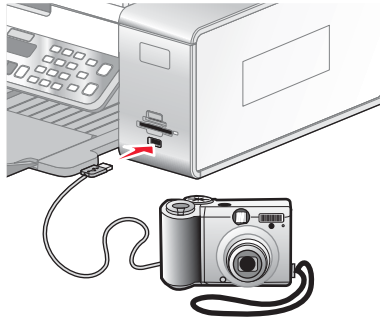

Warning: Do not touch the USB cable, any network adapter, or the printer in the area shown while actively printing from a PictBridge-enabled digital camera. A loss of data can occur. Also, do not remove the USB cable or network adapter while actively printing from a PictBridge-enabled digital camera.



Notes:

- Make sure the PictBridge-enabled digital camera is set to the correct USB mode. For more information, see the camera documentation.
- The printer recognizes one active media device at a time. If you insert more than one media device, a message appears on the display prompting you to designate the device you want the printer to recognize.
- If you have a memory card inserted when you connect a PictBridge-enabled camera, an error message will be displayed telling you to remove one of the devices.
- If the PictBridge connection is successful, the following appears on the printer display: **PictBridge camera detected. Press \checkmark to change settings.** If any other message appears, see “Error messages on the computer screen” on page 197.
- Values selected within the menu items are the settings used for Pictbridge printing if no explicit selection is made from the camera.

- 3 Follow the instructions in the camera documentation to select and print photos.

Note: If the printer is turned off while the camera is connected, you must disconnect and then reconnect the camera.

Printing photos from a digital camera using DPOF

Digital Print Order Format (DPOF) is a feature available on some digital cameras. If your camera supports DPOF, you can specify which photos to print, how many of each, and print settings while the memory card is still in the camera. The printer recognizes these settings when you insert the memory card into the printer.

Note: Make sure the photo print settings you select in the camera match your current printer settings.

- 1 Load photo paper with the glossy or printable side facing you. (If you are not sure which side is the printable side, see the instructions that came with the paper.)
- 2 Insert a memory card.
- 3 Press ◀ or ▶ repeatedly until **Print Photos** appears.
- 4 Press ✓.
- 5 Press ◀ or ▶ repeatedly until **Print DPOF** appears.
- 6 Press **Start Color** or **Start Black**.

Printing photos by date range

- 1 Load photo paper with the glossy or printable side facing you. (If you are not sure which side is the printable side, see the instructions that came with the paper.)
- 2 Insert a memory card or flash drive that contains the images you want to print.
- 3 Press ◀ or ▶ repeatedly until **Print Photos** appears.
- 4 Press ✓.
- 5 Press ◀ or ▶ repeatedly until **Date Range** appears.
- 6 Press ✓.
Dates are displayed by month and year starting with the most recent month.
- 7 Press ◀ or ▶ to select the month you want.
- 8 Press ✓.
- 9 Press **Start Color** or **Start Black**.

The print settings to be used on the print job are displayed sequentially on the second line of the display.

- 10 Press **Start Color** or **Start Black** again.

Printing photos using color effects

You can automatically enhance the color of your photos or print photos in antique tones.

Note: You can also print photos with color effects using a proof sheet. For more information, see “Printing photos stored on the memory device using the proof sheet” on page 93.

- 1 Load photo paper with the glossy or printable side facing you. (If you are not sure which side is the printable side, see the instructions that came with the paper.) For more information, see “Loading paper” on page 60.
- 2 Insert a memory card or flash drive that contains the images you want to print. For more information, see “Inserting a memory card” on page 78 or “Inserting a flash drive” on page 79.

3 Press ◀ or ▶ repeatedly until **Photo Effects** appears.

4 Press ✓.

5 Press ◀ or ▶ repeatedly until the color effect you want appears.

Note: Color effect selections include Auto Enhance, Sepia, Antique Grey, and Antique Brown.

6 Press ✓.

Note: The selected color effect applies to all the photos you print until the active memory card or flash drive is removed.

Creating and viewing a slideshow

1 From the Productivity Studio Welcome Screen, click **Work with Documents and Photos**.

2 Select the folder that contains the photos you want to include in the slideshow. Thumbnails of the photos in the folder will appear in a preview pane.

3 Click to select the photos you want to include in the slideshow, and then select **Slideshow**.

If you want additional photos to appear in specific order, click the photos in the order you want them to appear, and then drag them into the “Photos in Your Slideshow” area.

4 Click the **Slideshow Settings** tab to adjust the amount of time between each photo in the slideshow. You can also modify the setting that lets the slideshow replay automatically (loop).

5 Click the **Share** tab to save or print your slideshow.









6 Click **View Show** in the lower-right corner of the window to start the slideshow.

Note: You can exit the slideshow any time by moving your cursor to the bottom center of the screen and clicking **Exit Slideshow**.

Copying

Understanding the Copy menu

To understand and use the Copy menu:

- 1 From the control panel, press **Copy Mode**.
The copy default screen appears.
 - 2 If you do not want to change a setting, press **Start Color** or **Start Black**.
 - 3 If you want to change a setting, press .
 - 4 Press  or  repeatedly until the menu item you want appears.
 - 5 Press .
 - 6 Press  or  repeatedly until the submenu item you want or the setting you want appears.
 - 7 Press .
- Note:** Pressing  selects a setting. An * appears next to the selected setting.
- 8 To go into additional submenus and settings, repeat step 6 and step 7 as needed.
 - 9 If necessary, press  repeatedly to return to the previous menus and make other setting selections.
 - 10 Press **Start Color** or **Start Black**.

Use this	To
Copies*	Specify how many copies to print.
Resize*	<ul style="list-style-type: none">• Specify the percentage for enlarging or reducing the original copy.• Specify a specific copy size.• Create a multiple-page poster.
Lighter / Darker*	Adjust the brightness of a copy.
Quality*	Adjust the quality of a copy.
Paper Setup	Specify the size and type of the paper loaded.
Repeat Image*	Choose how many copies of an image to print on a page.
Collate	Print one or more copies in the correct order.
N-Up*	Choose how many pages to print on a page.
2-Sided Original	Specify if you have a two-sided original document.
Original Size*	Specify the size of the original document.
Original Type*	Specify the type of the original document.
* Temporary setting. For information on saving temporary and other settings, see "Saving settings" on page 39.	



Copying on both sides of the paper using the scanner glass

The printer has a built-in duplex unit that lets you copy on both sides of the paper.

Note: For two-sided copying, use only plain paper in letter or A4 size. Do *not* make two-sided copies on envelopes, card stock, or photo paper.



- 1 Load paper.
- 2 Load an original document facedown on the scanner glass.
- 3 Make sure the  light is on.
- 4 From the control panel, press **Copy Mode**.
- 5 Adjust the copy settings.

Note: If you are copying a two-sided original document, press the  button, and select the menu item **2-Sided Original**.

- 6 Press  to save your settings temporarily.
- 7 Press .

The printer scans the first page of the original document. A page prints, and then is pulled back into the printer.

CAUTION: Do *not* touch the paper while the printer is actively printing.

- 8 When asked if you want to **Scan another page?**, press  to choose **Yes**.
- 9 Place the next page facedown on the scanner glass. If you have a two-sided original, load the original document with the other side facedown on the scanner glass, and then press .
- 10 Repeat step 8 and step 9 for each two-sided copy you want to make.

The printer scans the next page—or the other side of the original document—and then prints.

Copying on both sides of the paper using the Automatic Document Feeder (ADF)

The printer has a built-in duplex unit that lets you copy on both sides of the paper.

Note: For two-sided copying, use only plain paper in letter or A4 size. Do *not* make 2-sided copies on envelopes, card stock, or photo paper.

- 1 Load paper.
- 2 Load an original document faceup in the Automatic Document Feeder.
- 3 Make sure the  light is on.
- 4 From the control panel, press **Copy Mode**.
- 5 Adjust the copy settings.

Note: If you are copying a two-sided original document, press  twice and select the menu item **2-Sided Original**.

- 6 Press  to save your settings temporarily.

7 Press .

The printer scans the front side of each page of the original document.

8 If you are copying a two-sided original document, the printer will display this message: **Reload the Original in the Automatic Document Feeder without flipping or rotating the stack, then press .**

9 Press .

Copying photos

1 Load photo paper with the glossy or printable side facing you. (If you are not sure which side is the printable side, see the instructions that came with the paper.)

2 Place a photo facedown on the scanner glass in the lower right corner. For more information, see “Loading original documents on the scanner glass” on page 63.

3 From the control panel, press **Copy Mode**.



4 Press .

5 Press  or  repeatedly until **Quality** appears.



6 Press .

7 Press  or  repeatedly until **Photo** appears.



8 Press .

9 Press  or  repeatedly until **Paper Setup** appears.



10 Press .

11 Press  or  repeatedly until **Paper Size** appears.

12 Press .

13 Press  or  repeatedly until the size you want appears.

14 Press .

15 Press  or  repeatedly until **Paper Type** appears.

16 Press .

17 Press  or  repeatedly until the type of paper loaded into the printer appears.

18 Press .

19 Press **Start Color** or **Start Black**.

Copying a photo using the computer



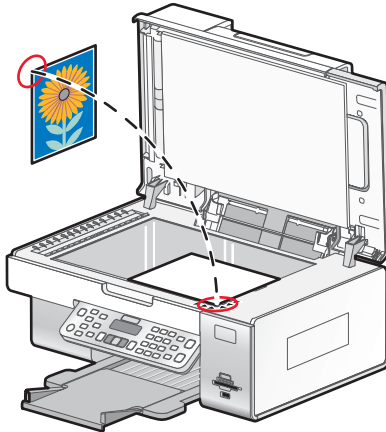



- 1 Place the photo facedown on the scanner glass.



- 2 From the desktop, double-click the **Productivity Studio** icon.
- 3 From the Welcome screen, click **Copy**.
- 4 Select **Photo**.
- 5 Click **Start**.
The photo appears in the right pane.
- 6 From the Quality drop-down list, select the copy quality.
- 7 From the Paper Size in Printer drop-down list, select the paper size.
- 8 From the Paper Type in Printer drop-down list, select the paper type.
- 9 To select multiple prints of a photo, or to select photo sizes other than 4 x 6 in. (10 x 15 cm), select the options you want in the table. Use the drop-down list in the last column to view and select other sizes.
- 10 Click **Copy Now** in the bottom right corner of the screen.

Adjusting copy quality

Quality specifies the resolution used for the copy job. Resolution involves a dots-per-inch (dpi) count; the higher the dpi count, the higher the resolution and copy quality.

- 1 Load paper.
- 2 Load an original document facedown on the scanner glass.
- 3 If necessary, press **Copy Mode**.
- 4 Press .
- 5 Press  or  repeatedly until **Quality** appears.
- 6 Press .
- 7 Press  or  repeatedly until the quality you want appears.

8 Press **✓**.

9 Press **Start Color** or **Start Black**.

Making borderless copies using the control panel

- 1 Load photo paper with the glossy or printable side facing you. (If you are not sure which side is the printable side, see the instructions that came with the paper.)
- 2 Place a photo facedown on the scanner glass in the lower right corner. For more information, see “Loading original documents on the scanner glass” on page 63.
- 3 From the control panel, press **Copy Mode**.
- 4 Press .
- 5 Press **◀** or **▶** repeatedly until **Resize** appears.
- 6 Press **✓**.
- 7 Press **◀** or **▶** repeatedly until **Borderless** appears.
- 8 Press **✓**.
- 9 Press **◀** or **▶** repeatedly until **Paper Setup** appears.
- 10 Press **✓**.
- 11 Press **◀** or **▶** repeatedly until **Paper Size** appears.
- 12 Press **✓**.
- 13 Press **◀** or **▶** repeatedly until the size you want appears.
- 14 Press **✓**.
- 15 Press **◀** or **▶** repeatedly until **Paper Type** appears.
- 16 Press **✓**.
- 17 Press **◀** or **▶** repeatedly until either **Automatic** or **Photo** appears.
- 18 Press **✓**.
- 19 Press **Start Color** or **Start Black**.

Making a copy lighter or darker

If you want to adjust the look of a copy or photo, you can adjust it to make it lighter or darker.

1 Load paper.

Note: If you are copying photos, use photo or heavyweight matte paper, with the glossy or printable side facing you. (If you are not sure which side is the printable side, see the instructions that came with the paper.)

2 Load an original document facedown on the scanner glass.

3 From the control panel, press **Copy Mode**.

- 4 Press **Lighter/Darker**.
- 5 Press ◀ or ▶ repeatedly to adjust the slider.
- 6 Press ✓.
- 7 Press **Start Color** or **Start Black**.

Collating copies using the control panel

If you print multiple copies of a document, you can choose to print each copy as a set (collated) or to print the copies as groups of pages (not collated).

Collated



Not collated



- 1 Load paper.
- 2 Load an original document facedown on the scanner glass.
- 3 From the control panel, press **Copy Mode**.
- 4 Press .
- 5 Press ◀ or ▶ repeatedly until **collate** appears.
- 6 Press ✓.
- 7 Press ◀ or ▶ repeatedly until **on** appears.

Note: You can collate copies only if you did not make any changes in the **Resize** menu.
- 8 Press **Start Color** or **Start Black**.

Note: If you are using the scanner glass, a message appears prompting you for additional pages.
- 9 Press ✓ to continue copying more pages.
- 10 After the last page, press ◀ or ▶ repeatedly until **no** appears.
- 11 Press ✓.

Repeating an image on one page

You can print the same image multiple times on one sheet of paper. This option is helpful in creating labels, decals, flyers, and handouts.

- 1 Load paper.

Note: If you are copying photos, use photo or heavyweight matte paper, with the glossy or printable side facing you. (If you are not sure which side is the printable side, see the instructions that came with the paper.)
- 2 Load an original document facedown on the scanner glass.
- 3 From the control panel, press **Copy Mode**.
- 4 Press .

- 5 Press ◀ or ▶ repeatedly until **Repeat Image** appears.
- 6 Press ✓.
- 7 Press ◀ or ▶ repeatedly until the number of images you want to print on one page appears.
- 8 Press **Start Color** or **Start Black**.

Enlarging or reducing an image

- 1 Load paper.
Note: If you are copying photos, use photo or heavyweight matte paper, with the glossy or printable side facing you. (If you are not sure which side is the printable side, see the instructions that came with the paper.)
- 2 Load an original document or photo facedown on the scanner glass.
- 3 From the control panel, press **Copy Mode**.
- 4 Press .
- 5 Press ◀ or ▶ repeatedly until **Resize** appears.
- 6 Press ✓.
- 7 Press ◀ or ▶ repeatedly until the setting you want appears.

Notes:

- If you select **Custom Resize**, press and hold ◀ or ▶ until the size you want appears and press ✓.
- If you select **Borderless**, the printer will reduce or enlarge the document or photo as necessary to print a borderless copy on the paper size you have selected. For best results with this resize setting, use photo paper and set the paper type selection to Automatic or Photo.

- 8 Press **Start Color** or **Start Black**.

Modifying the Copy settings

- 1 With your scanned image open on the Copy screen, click the **Settings** tab.
- 2 From the Copies box, select the number of copies you want.
- 3 From the Quality drop-down list, select a copy quality.
- 4 From the Paper Size in Printer drop-down list, select the paper size.
- 5 Select the print size by clicking the appropriate thumbnail in the Print Size area of the screen, or use the drop-down list.
- 6 When you have finished making changes to the copy settings, click **Copy Now** from the right pane of the screen.
The photo will be copied.

Scanning

Scanning a document

- 1 Make sure the printer is connected to a computer, and both the printer and the computer are on.
 - 2 Load an original document facedown on the scanner glass.
 - 3 From the control panel, press **Scan Mode**.
 - 4 If your printer is connected to more than one computer:
 - a Press ◀ or ▶ repeatedly until the computer to which you want to scan appears.
 - b Press ✓.

If you set a PIN during network setup and are being asked for it:

 - 1 Enter the PIN using the keypad.
 - 2 Press ✓.
 - 5 Wait until the printer has finished downloading the scan applications list.
 - 6 Press ◀ or ▶ repeatedly until destination to which you want to scan to appears.
 - 7 Press **Start Color** or **Start Black**.
- Note:** If you are using a Macintosh operating system, you may need to click **Scan** from the Scan dialog on the computer screen.
- 8 If you want to save the scanned image, from the software application, click **File → Save As**.
 - 9 Enter the file name, format, and location where you want the scanned image saved.
 - 10 Click **Save**.

Scanning a document using the computer

- 1 Load an original document facedown on the scanner glass.

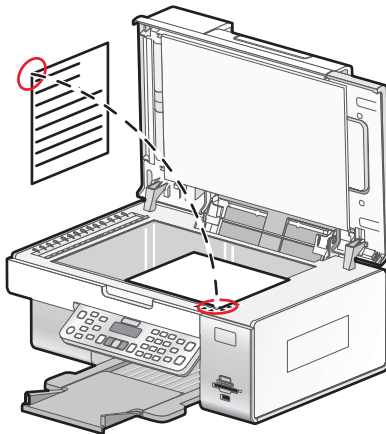

- 2 From the desktop, double-click the **Productivity Studio** icon.
- 3 Click **Scan**.

4 Select the **Document** option.

5 Click **Start**.

The scanned document is loaded into your default word processing application. You can now edit the document.

Scanning text for editing

The Optical Character Recognition (OCR) feature turns a scanned document into text you can edit with a word-processing application.

1 Make sure the printer is connected to a computer, and both the printer and the computer are powered on.

2 Load an original document facedown on the scanner glass.

3 From the desktop, double-click the **Productivity Studio** icon.

4 From the Welcome Screen, click **Scan and Edit Text (OCR)**.

5 Select the **Document** option.

6 Click **Start**.

The scanned document is loaded into your default word-processing application. You can now edit the document.

Scanning images for editing

1 Make sure the printer is connected to a computer, and both the printer and the computer are on.

2 Load an original document facedown on the scanner glass.

3 From the desktop, double-click the **Productivity Studio** icon.

4 Click **Scan**.

5 Select the **Photo** or **Several Photos** option.

6 Click **Start**.

You can edit the scanned image.

Scanning a photo to Work with Documents and Photos

1 Load a photo facedown on the scanner glass.

2 From the desktop, double-click the **Productivity Studio** icon.

3 Click **Work with Documents and Photos**.

4 From the Add menu, click **Add New Scan**.

5 Select the **Photo** option.

6 Click **Start**.

The photo is placed in the current folder in Work with Documents and Photos.

Scanning multiple photos at one time using the computer

- 1 Place the photos facedown on the scanner glass.

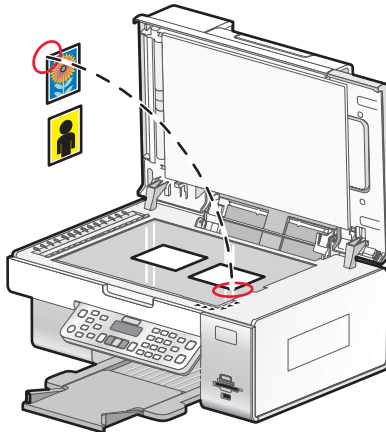

Note: For best results, place photos with the most space possible between the photos and the edges of the scan area.

- 2 From the desktop, double-click the **Productivity Studio** icon.
- 3 Click **Scan**.
- 4 Select the **Several Photos** option.
- 5 Click **Start**.

Creating a PDF from a scanned item

- 1 Load an original document facedown on the scanner glass.
- 2 From the desktop, double-click the **Productivity Studio** icon.
- 3 From the Welcome Screen, click **Convert to PDF**.
- 4 Select **Photo**, **Several Photos**, or **Document**.
- 5 Click  to begin scanning.
- 6 Click **Add Another** to scan additional images, or to add an image from the Library.
- 7 To add or scan another image, do one of the following:
 - Select **Add New Scan** and repeat step 3 to scan another image
 - or*
 - Select **Add Photo from Photo Library** to add a previously scanned image. Select or deselect images by clicking on them in the preview pane.

Click **Add Files** when you have made your selections.

- 8 Select **Save all images as one PDF file** or **Save each image as individual PDF file**.
- 9 Click **Create PDF**.
- 10 If you want to save the scanned image separately, make your selections and click **Save**. Otherwise, click **Cancel** when the Photo Save options appear.

The software prepares your PDF and opens a Save dialog.

11 Enter a file name for your PDF and select a storage location.

12 Click **Save**.

Canceling a scan job

To cancel a job being scanned on the scanner glass, go to the control panel, and press .

To cancel a scan job started in the Productivity Studio, click **Scan** and then click **Stop**.

Customizing scan settings using the computer

1 From the desktop, double-click the **Productivity Studio** icon.

2 Click **Scan**.

3 Click **Custom Settings**.

4 Change the settings as needed.



Setting	Options
Color Depth	Select Color, Grey, or Black and White.
Scan Resolution (Dots Per Inch)	Select a scan resolution value from the drop-down list.
Size	<ul style="list-style-type: none">You can auto-crop the scanned item.You can select the area to be scanned. From the drop-down list, select a paper source.
Select area to be scanned	Select the area to be scanned by choosing a paper size from the drop-down list.
Convert the image to text with OCR	Convert an image to text.
Always use these settings when scanning	Make your selections permanent by selecting the check box.

Understanding the Scan menu

To understand and use the Scan menu:



1 From the control panel, press **Scan Mode**.

The scan default screen appears.

2 Press  or  repeatedly until the scan destination you want appears.

3 If you do not want to change a setting, press **Start Color** or **Start Black**.

4 If you want to change a setting, press .

5 Press  or  repeatedly until the menu item you want appears.

6 Press .

7 Press  or  repeatedly until the submenu item or the setting you want appears.

8 Press ✓.

Note: Pressing ✓ selects a setting. An asterisk (*) appears next to the selected setting.

9 To go into additional submenus and settings, repeat pressing ◀ or ▶ repeatedly until the submenu item or the setting you want appears, and then press ✓.

10 If needed, press ↶ repeatedly to return to the previous menus and make other setting selections.

11 Press **Start Color** or **Start Black**.

Use this	To
Quality ¹	Adjust the quality of a scan.
Original Size ¹	Specify the size of the original document.

¹ Temporary setting. For information on saving temporary and other settings, see "Saving settings" on page 39.

Scanning to a computer over a network

Make sure:

- The printer is connected to the network through a print server, and the printer and computer receiving the scan are on.
- The printer is configured to scan over a network (Direct IP Printing).

1 Load an original document facedown on the scanner glass.

2 From the control panel, press **Scan Mode**.

3 Press ◀ or ▶ repeatedly until the computer to which you want to scan is highlighted.

4 Press ✓.

5 Press ◀ or ▶ repeatedly until the scan destination you want appears.

6 Press **Start Color** or **Start Black**.

Saving a scanned image on the computer

1 Load an original document facedown on the scanner glass.

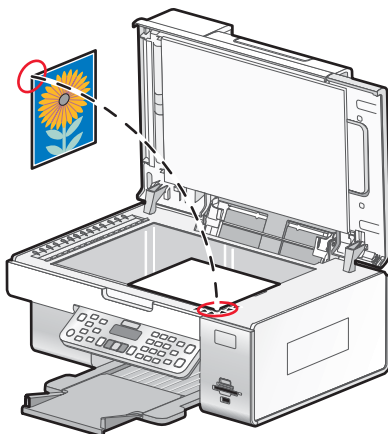

- 2 Close the top cover.
- 3 From the desktop, double-click the **Productivity Studio** icon.
- 4 Click **Scan**.
- 5 Select the **Photo** or **Several Photos** option.
- 6 Click **Start**.
- 7 From the Save or Edit screen menu bar, click **Save**.
- 8 To save to another folder, click **Browse**, and select a folder. Click **OK**.
- 9 To rename the file, enter the name in the File Name area. To assign the name as a prefix to all of your photos, select the **Start all photos with File Name** check box.
- 10 To save the photo as another file type, select the file type from the File Type drop-down list.
- 11 To select a date for the photo, click the drop-down list, and select a date from the calendar.
- 12 Click **Save**.

Scanning clear images from magazines or newspapers

Use the descreening feature to help remove wavy patterns from images scanned from magazines or newspapers.

- 1 Make sure the printer is connected to a computer, and both the printer and the computer are on.
- 2 Load an original document faceup into the Automatic Document Feeder (ADF) or facedown on the scanner glass.
Note: Do not load postcards, photos, small items, transparencies, photo paper, or thin media (such as magazine clippings) into the Automatic Document Feeder (ADF). Place these items on the scanner glass.
- 3 From the desktop, double-click the **Productivity Studio** icon.
- 4 From the Welcome Screen, click **Scan**.
- 5 Click **Display Advanced Scan Settings**.
- 6 Select the **Image Patterns** tab.
- 7 Select the **Remove image patterns from magazine/newspaper (descreen)** check box.
- 8 From the “What was scanned?” menu, select **Magazine** or **Newspaper**.
- 9 Click **OK**.
- 10 From the “Send scanned image to” menu, select the destination to which you want to send the scan.
- 11 Click **Scan Now**.

Changing the Productivity Studio scan settings

- 1 From the desktop, double-click the **Productivity Studio** icon.
- 2 From the Tools menu, click **Preferences**.
- 3 Click **Scan Settings**.
 - Select **Always use simple scan settings** to use the default scan settings.
 - Select **Always start scanning with the settings below** to customize the remaining scan settings.

- From the Color Depth: area, select the color depth from the drop-down list.
- From the Scan Resolution (Dots per inch): area, select the resolution value from the drop-down list.
- Click **Auto-crop the scanned item** to use the slider to select your cropped value.
- Click **Select area to be scanned** to select the value from the drop-down list.
- Click **Convert images to text with OCR** to convert images to text.

4 Click **OK**.

Adding a file to an e-mail message

- 1 From the desktop, double-click the **Productivity Studio** icon.
- 2 Under **Document Management**, click **Work with Documents and Photos**.
- 3 Click **Add**, and select **Add File On My Computer**.
- 4 Open the folder where the file is stored. The thumbnail is displayed in the list of files to be sent.
- 5 Click **Open** to select a file.
- 6 From **Work with Documents and Photos**, select the file that you want to add.
- 7 Click **E-mail** to create an e-mail message with your scanned image(s) attached.

Adding a new scanned image to an e-mail message

- 1 From the desktop, double-click the **Productivity Studio** icon.
- 2 Place the image facedown on the scanner glass, and close the top cover.
- 3 Click **E-mail**.
- 4 Click **Start**. The image is scanned.
- 5 From the Send Quality and Speed area of the screen, select the image size.
- 6 Click **Create E-mail** to create an e-mail message with your scanned image(s) attached.

Scanning documents or images for e-mailing

You can e-mail attached scanned images using your default e-mail application.

- 1 Load an original document facedown on the scanner glass.

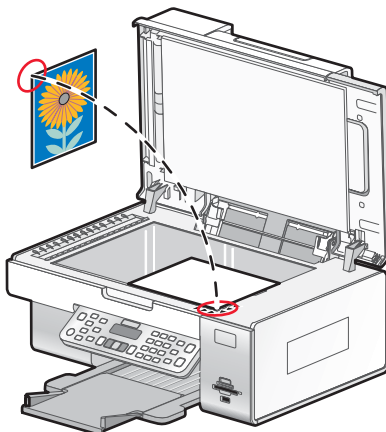

- 2 From the desktop, double-click the **Productivity Studio** icon.
- 3 Click **E-mail**.
- 4 Select from the **Photo**, **Several Photos**, or **Document** options.
- 5 Click **Start**.
- 6 If you are scanning a photo, select the Photo Size from the Send Quality and Speed area.
- 7 Click **Create E-mail** to have your images attached to an e-mail message.

Changing the Productivity Studio e-mail screen preferences

- 1 From the desktop, double-click the **Productivity Studio** icon.
- 2 From the Tools menu, click **Preferences**.
- 3 Click **E-mail Screen**.
 - Click **Remember my last selection** to use the photo size you selected in your most recent e-mail message.
 - Click **Original Size (Good for Printing)** to send photo attachments at their original size.
 - Click **Reduced to: 1024 x 768 (Good for Full-screen Viewing)** to send photo attachments at 1024 x 768 pixels.
 - Click **Reduced to: 640 x 480 (Good for Quick Viewing)** to send photo attachments at 640 x 480 pixels.
- 4 Click **OK**.

Faxing

 **CAUTION:** Do not use the fax feature during a lightning storm. Do not set up this product or make any electrical or cabling connections, such as the power supply cord or telephone, during a lightning storm.

Sending a fax

Entering a fax number

- 1 From the control panel, press **Fax Mode**.
- 2 Enter a fax number using:

The text box	Enter a fax number using the keypad. Notes: <ul style="list-style-type: none">• You can include a calling card number as part of the fax number.• Enter a maximum of 64 digits in a fax number, which can include the symbols * or #.• Press Redial / Pause to insert a three-second pause in a number you are entering to wait for an outside line or get through an automated answering system.
Speed Dial or Group Dial	<ol style="list-style-type: none">a Press Phone Book.b Enter Speed Dial and/or Group Dial numbers.<ul style="list-style-type: none">• Press ◀ or ▶ repeatedly until the Speed Dial or Group Dial number you want appears.• Use the keypad to enter the number of the Speed Dial entry (1–89) or Group Dial entry (90–99). Notes: <ul style="list-style-type: none">• For instructions on how to add Speed Dial or Group Dial numbers using the computer, see “Setting up Speed Dial” on page 128.• For instructions on how to add Speed Dial or Group Dial numbers using the control panel, see “Using the control panel Phone Book” on page 119.

- 3 If you want to send a fax to a group of numbers (broadcast fax):
 - a Press ✓ after each fax number.
 - b Repeat entering fax numbers, using any combination of the previous methods, until a maximum of 30 fax numbers have been entered.

Sending a fax using the software

You can scan a document to the computer and then fax it to someone using the software.

- 1 Load an original document facedown on the scanner glass.
- 2 From the desktop, double-click the **Productivity Studio** icon.
- 3 From the Welcome Screen, click **Fax**.

- 4 Select the **Document** option.
- 5 Click **Start**.
- 6 Enter the recipient information, and then click **Next**.

Note: A fax number can include up to 64 numbers, commas, periods, spaces, and/or these symbols: * # + - ().
- 7 Enter the cover page information, and then click **Next**.
- 8 If there are any additional documents that you want to send with your fax, add these now, and then click **Next**.
- 9 To send your fax:
 - Immediately—Select the “Send now” option.
 - At a scheduled time:
 - a Select the “Delay sending until” option.
 - b Set a time and date.
- 10 If you want a paper copy of your fax, select **Print a copy of your fax**.
- 11 Click **Send**.

Sending a fax using the control panel

Make sure the printer is on.

- 1 Load an original document facedown on the scanner glass.
- 2 From the control panel, press **Fax Mode**.
- 3 Enter a fax number using:

The text box	<p>Enter a fax number using the keypad.</p> <p>Notes:</p> <ul style="list-style-type: none"> • You can include a calling card number as part of the fax number. • A fax number can include up to 64 numbers, commas, periods, and/or these symbols: * #. • Press Redial / Pause to insert a three-second pause in a number you are entering to wait for an outside line or get through an automated answering system.
Speed Dial or Group Dial	<p>a Press Phone Book.</p> <p>b Enter Speed Dial and/or Group Dial numbers.</p> <ul style="list-style-type: none"> • Press ◀ or ▶ repeatedly until the Speed Dial or Group Dial number you want appears. • Use the keypad to enter the number of the Speed Dial entry (1–89) or Group Dial entry (90–99). <p>Notes:</p> <ul style="list-style-type: none"> • For instructions on how to add Speed Dial or Group Dial numbers using the computer, see “Setting up Speed Dial” on page 128. • For instructions on how to add Speed Dial or Group Dial numbers using the control panel, see “Using the control panel Phone Book” on page 119.

- 4 If you want to send a fax to a group of numbers (broadcast fax):
 - a Press ✓.
 - b Add fax numbers for the group, and press ✓ until all have been entered, for a maximum of 30.
- 5 Press **Start Color** or **Start Black**.

Sending a fax while listening to a call (On Hook Dial)

The manual dialing feature lets you dial a telephone number while listening to the call through a speaker on the printer. It is useful when you must navigate an automated answering system or enter a calling card number before sending your fax.

- 1 From the control panel, press **Fax Mode**.
- 2 Press .
- 3 Press ◀ or ▶ repeatedly until **On Hook Dial** appears, and then press ✓. You can now hear the dial tone of the telephone line.
- 4 Enter a fax number. For more information, see the related topic, “Entering a fax number.”

Note: Press the keypad numbers to use an automated answering system.
- 5 Press **Start Color** or **Start Black**.

Sending a broadcast fax at a scheduled time

You can send a fax to a group of fax numbers at a time you choose.

- 1 Load an original document facedown on the scanner glass.
- 2 From the control panel, press **Fax Mode**.
- 3 Press .
- 4 Press ◀ or ▶ repeatedly until **Delay Fax** appears.
- 5 Press ✓.
- 6 Press ◀ or ▶ repeatedly until **Delay Until** appears.
- 7 Press ✓.
- 8 Enter the time you want to send the fax.
- 9 Press ✓.
- 10 If the printer is not set to the 24-hour mode, press ◀ or ▶ repeatedly to select AM or PM, and then press ✓ to save your settings.
- 11 Enter a fax number, or press **Phone Book** to select a number from the Speed Dial or Group Dial list. For more information, see “Entering a fax number” on page 113.
- 12 If needed, add more fax numbers, and press ✓ until all, for a maximum of 30, have been entered.
- 13 Press **Start Color** or **Start Black**.

Note: At the designated time, the fax program dials and sends the fax to all of the designated fax numbers. If the fax transmission is unsuccessful to any of the numbers on the broadcast list, the unsuccessful numbers will be dialed again.

Receiving a fax

Receiving a fax manually

- 1 Make sure the Auto Answer light is off.
- 2 To receive the fax if you have not set up a manual answer code:
 - Press **Start Color** or **Start Black**.
 - or*
 - Press * 9 * on the telephone after you answer it and hear fax tones.
- 3 To receive a fax if you have set up a manual answer code, enter the code on the telephone after you answer it and hear fax tones.

Note: For information on how to set up a manual answer code, see the related topic, “Setting a fax manual answer code.”

- 4 Hang up the telephone. The printer receives the fax.

Setting a fax manual answer code

- 1 From the desktop, double-click the **Productivity Studio** icon.
- 2 From the Settings area of the Welcome Screen, click **Fax History and Settings**.
- 3 From the “I Want To” menu, click **Adjust speed dial list and other fax settings**.
- 4 Click the **Ringing and Answering** tab.
- 5 From the “Answering on your phone line type” area, enter the code you want to use.

Note: The code can include up to seven numbers, commas, periods, spaces, and/or these symbols: * # + - ().

- 6 Click **OK** to save the setting.

Using Caller ID from the control panel

Caller ID is a service provided by some telephone companies that identifies the telephone number or the name of the person who is calling. If you subscribe to this service, it works with the printer. When you receive a fax, the telephone number or name of the person who is sending you the fax appears on the display.

Notes:

- Caller ID is available only in some countries and regions.
- The number of patterns is defined by the country or region setting and only the number of patterns defined for the selected country or region is shown.

The printer supports two distinct Caller ID patterns: Pattern 1 (FSK) and Pattern 2 (DTMF). Depending on the country or region you live in and the telecommunications company you subscribe to, you may need to switch the pattern to display Caller ID information.

- 1 From the control panel, press **Settings**.
- 2 Press ◀ or ▶ repeatedly until **Device Setup** appears.
- 3 Press ✓.
- 4 Press ◀ or ▶ repeatedly until **Caller ID Pattern** appears.
- 5 Press ✓.

6 Press ◀ or ▶ repeatedly until the setting you want appears.

7 Press ✓ to save the setting.

Using Caller ID from the software

Caller ID is a service provided by some telephone companies that identifies the telephone number or the name of the person who is calling. If you subscribe to this service, it works with the printer. When you receive a fax, the telephone number or name of the person who is sending you the fax appears on the display.

Notes:

- Caller ID is available only in some countries and regions.
- The number of patterns is defined by the country or region setting and only the number of patterns defined for the selected country or region is shown.

The printer supports two distinct Caller ID patterns: Pattern 1 (FSK) and Pattern 2 (DTMF). Depending on the country or region you live in and the telecommunications company you subscribe to, you may need to switch the pattern to display Caller ID information.

- 1 From the desktop, double-click the **Productivity Studio** icon.
- 2 From the Settings area of the Welcome Screen, click **Fax History and Settings**.
- 3 From the “I Want To” menu, click **Adjust speed dial list and other fax settings**.
- 4 Click the **Ringling and Answering** tab.
- 5 From the “Answering on your phone line type” section, select the pattern number you want from the “Caller ID pattern” drop-down list.
- 6 Click **OK** to save the setting.

Receiving a fax automatically

- 1 From the desktop, double-click the **Productivity Studio** icon.
- 2 From Settings area of the Welcome Screen, click **Fax History and Settings**.
- 3 From the “I Want To” menu, click **Adjust speed dial list and other fax settings**.
- 4 Click the **Ringling and Answering** tab.
- 5 From the “Automatically answer incoming calls as a fax” area, select **On** from the Auto Answer drop-down list.
- 6 To turn the Auto Answer feature on and off at scheduled times, select the settings you want from the drop-down lists.
- 7 The Auto Answer light on the control panel comes on when the Auto Answer feature is enabled.
- 8 To set the number of telephone rings before the printer automatically receives faxes, select a setting from the “Pick-up on the” drop-down list in the “Answering on your phone line type” area.
- 9 Click **OK** to save the settings.

Receiving a fax with an answering machine

Note: You must set up the equipment as shown in the related topic, “Connecting to an answering machine” on page 30.

To receive a fax with an answering machine connected to the printer:

- 1 Make sure that the Auto Answer light is on.
- 2 Make sure you have set the number of times the telephone rings before receiving a fax automatically. For more information, see “Setting the number of rings before receiving a fax automatically” on page 128.

When a telephone ring is detected, the answering machine picks up the call.

- If the printer detects a fax, it receives the fax and disconnects the answering machine.
- If the printer does not detect a fax, the answering machine receives the call.



- 3 Set the answering machine to answer incoming calls before the printer does.

For example, if you set the answering machine to answer calls after three rings, set the printer to answer calls after five rings.

Receiving a two-sided fax

The printer has a built-in duplex unit that lets you print received faxes on both sides of the paper.

Note: For two-sided printing, use only plain paper in letter or A4 size.

- 1 From the control panel, press .
The  light comes on.
- 2 Press **Fax Mode**.
- 3 Press .
- 4 Press ◀ or ▶ repeatedly until **Fax Setup** appears.
- 5 Press ✓.
- 6 Press ◀ or ▶ repeatedly until **Fax Printing** appears.
- 7 Press ✓.
- 8 Press ◀ or ▶ repeatedly until **2-Sided Faxes** appears.
- 9 Press ✓.
- 10 Press ◀ or ▶ repeatedly until **Always** appears.
- 11 Press ✓ to save and exit.

Your faxes will now print on both sides of the paper.

Forwarding faxes

Use the fax-forwarding feature if you are going to be away but still want to receive your faxes. There are three fax-forwarding settings:

- **Off**—(Default)
- **Forward**—The printer sends the fax to the designated fax number.
- **Print & forward**—The printer prints the fax and then sends it to the designated fax number.

To set up fax forwarding:

- 1 From the desktop, double-click the **Productivity Studio** icon.
- 2 From the Settings area of the Welcome screen, click **Fax History and Settings**.
- 3 From the “I Want To” menu, click **Adjust speed dial list and other fax settings**.
- 4 Click the **Ringing and Answering** tab.
- 5 From the “Forward received faxes to another number” area, select the setting you want from the “Fax forwarding” drop-down list.
- 6 Enter the number to which you want to forward the fax.

Notes:

- You can include a calling card number as part of the fax number.
- A fax number can include up to 64 numbers, commas, periods, spaces, and/or these symbols: * # + - ().

- 7 Click **OK** to save the setting.

Using the Phone Book

Using the control panel Phone Book

The control panel Phone Book is a directory of Speed Dial entries (1–89) and Group Dial entries (90–99).

To access a Phone Book entry:

- 1 From the control panel, press **Phone Book**.
- 2 Press ◀ or ▶ repeatedly until the entry you want appears.

or

Use the keypad to enter the number of the Speed Dial or Group Dial entry.

To access the Phone Book menu:

- 1 From the control panel, press **Fax Mode**.
- 2 Press .
- 3 Press ◀ or ▶ repeatedly until **Phone Book** appears.
- 4 Press ✓.
- 5 Press ◀ or ▶ repeatedly until the setting you want appears.
- 6 Press ✓, and follow the instructions on the display.

Use this	To
View	View Phone Book entries.
Add	Create a new Speed Dial or Group Dial entry.
Remove	Delete a Speed Dial or Group Dial entry.
Modify	Edit a Speed Dial or Group Dial entry.
Print	Print all Speed Dial and Group Dial entries in the Phone Book.

Note: For instructions on how to add Speed Dial or Group Dial entries to the Phone Book using the computer, see “Setting up Speed Dial” on page 128.

Using the computer Phone Book

Address books from your operating system appear as Phone Books.

To access a Phone Book entry:

- 1 From the desktop, double-click the **Productivity Studio** icon.
- 2 From the Welcome Screen, click **Fax History and Settings**.
- 3 From the “I Want To” menu, click **View phonebook**.
- 4 To modify the Phone Book, select an option, enter the new information, and click **OK**.

Use this	To
New Contact	Create a new Phone Book entry.
New Group	Create a new Group Phone Book entry.
Edit	Edit a Phone Book entry.
Delete	Delete a Phone Book entry.
Add Contact to Speed Dial list	Add a Phone Book entry to your Speed Dial or Group Dial list.

Note: For more information on how to set up multiple Speed Dial and/or Group Dial entries, see “Setting up Speed Dial” on page 128.

Customizing fax settings

Customizing settings using the Fax Setup Utility

You can adjust the fax settings in the Fax Setup Utility. These settings apply to the faxes you send or receive.

- 1 From the desktop, double-click the **Productivity Studio** icon.
- 2 Click **Fax History and Settings**.
The Fax Solutions Software screen appears.
- 3 Click **Adjust speed dial list and other fax settings**.

The following screen appears.

Printer Setup Utility

Dialing and Sending | Ringing and Answering | Fax Printing/Reports | Speed Dial

Dialing on your phone line type

Dial method: PBX

Dial prefix:

Dial volume: High

Personal Information sent on each fax

Your fax number: 5555555555

Your fax name: CPD Fax

When fax can not be sent (busy signal)

Redial attempts: 3 times

Time between redials: 4 minutes

Sending options

When to scan document: After Dial

Maximum send speed: 33600

Default send quality: Standard

Automatic fax conversion: On

[Fax Set-up Wizard](#)

Defaults OK Cancel Help

4 Click each tab, and change the settings as needed.

Tab	Options
Dialing and Sending	<ul style="list-style-type: none"> • Select the telephone line format you want to use. • Enter a dialing prefix. • Select a dialing volume. • Enter your name and fax number. <p>Notes:</p> <ul style="list-style-type: none"> – You can include a calling card number as part of the fax number. – Enter a maximum of 64 digits in a fax number. <ul style="list-style-type: none"> • Select the number of times you want the machine to redial and the time between those attempts if the fax cannot be sent on the first try. • Choose whether to scan the entire document before dialing the number. <p>Note: Select After Dial if you are sending a large fax or a multiple-page color fax.</p> <ul style="list-style-type: none"> • Select a maximum send speed and print quality for outgoing faxes. • From the “Automatic fax conversion” line, select ON to match the resolution setting of the receiving fax machine.
Ringing and Answering	<ul style="list-style-type: none"> • Select incoming call options. • Select auto answer options. • Select whether you want to forward a fax, or print it and then forward it. • Enter a fax forwarding number. • Manage blocked faxes.
Fax Printing / Reports	<ul style="list-style-type: none"> • Automatically reduce an incoming fax to fit to the paper size loaded, or print it on two sheets of paper. • Choose whether to print a footer (the date, time, and page number) to appear on each page you receive. • Select a paper source. • Choose whether to print on both sides of the paper. • Select when to print fax activity and confirmation reports.
Speed Dial	Create, add to, edit, or delete entries from the Speed Dial list, including Group Dial entries.
Cover Page	Choose and customize your fax cover page and message.

5 Click **OK** after you finish customizing the settings.

6 Close the Fax Setup Utility.

Understanding the Fax menu



To understand and use the Fax menu:



- 1 From the control panel, press **Fax Mode**.

The fax default screen appears.

- 2 If you do not want to change a setting, enter the fax number and then press **Start Color** or **Start Black**.

- 3 If you want to change a setting, press .

- 4 Press  or  repeatedly until the menu item you want appears, and then press .

- 5 Press  or  repeatedly until the submenu item you want or the setting you want appears, and then press .

Note:

Pressing  selects a setting. An asterisk (*) appears next to the selected setting.

- 6 To go into additional submenus and settings, repeat step 5 on page 123.

- 7 If needed, press  repeatedly to return to the previous menus and make other setting selections.

- 8 Press **Start Color** or **Start Black** to send a fax.

The following table explains the function of each submenu or menu item in the **Fax Menu**.

Use this	To
Quality ¹	Adjust the quality of a fax you are sending.
Phone Book	Add, edit, and print names and fax numbers of individuals or groups.
On Hook Dial	Dial a telephone number while listening to the call through a speaker on the printer. This is useful when you must navigate an automated answering system before sending your fax.
Delay Fax	Enter a specific time to send a fax. Note: Make sure the date and time are entered correctly before setting a specific time to send a fax.
Lighter/Darker ¹	Adjust the brightness of a fax you are sending.
¹ Temporary setting. For information on saving temporary and other settings, see "Saving settings" on page 39.	













Use this	To
Fax Setup	<p>Access the Fax Setup menu and menu items. You can change the values and save them as user default settings.</p> <ul style="list-style-type: none"> • Print fax history or transmission status reports. • Customize settings in Ringling and Answering for receiving a fax. • Select fax printing options. • Customize settings in Dialing and Sending for sending a fax. • Block faxes from the numbers you specify. <p>Once each value is chosen, press  to save the values as user default settings and exit.</p> <p>Note: The user default setting remains in effect until you access the menu again, choose another value, and save it. An asterisk (*) appears next to the user default setting.</p>
<p>¹ Temporary setting. For information on saving temporary and other settings, see “Saving settings” on page 39.</p>	

Setting Auto Answer to on

- 1 From the desktop, double-click the **Productivity Studio** icon.
- 2 From the Welcome Screen, click **Fax History and Settings**.
- 3 From the “I Want To” menu, click **Adjust speed dial list and other fax settings**.
- 4 Click the **Ringling and Answering** tab.
- 5 From the Auto Answer drop-down list, select **On**.
- 6 Click **OK** to save the setting.

The Auto Answer light on the control panel comes on. When the number of rings you set is detected, the printer automatically receives the incoming fax.

Setting up a fax footer using the control panel

- 1 From the control panel, press **Fax Mode**.
- 2 Press .
- 3 Press  or  repeatedly until **Fax Setup** appears.
- 4 Press .
- 5 Press  or  repeatedly until **Fax Printing** appears.
- 6 Press .
- 7 Press  or  repeatedly until **Fax Footer** appears.
- 8 Press .
- 9 Press  or  repeatedly until **on** appears.

- 10 Press ✓.
- 11 During the initial setup of your printer, you were prompted to enter the date and time. If you have not entered this information:
 - a Press **Settings**.
 - b Press ✓.
 - c Press ◀ or ▶ repeatedly until **Device Setup** appears.
 - d Press ✓.
 - e Press ◀ or ▶ repeatedly until **Date/Time** appears.
 - f Press ✓.
 - g Enter the date using the keypad.
 - h Press ✓.
 - i Enter the time using the keypad.
 - j Press ✓.
 - k If the hour you entered is 12 or less, press ◀ or ▶ repeatedly until **AM, PM, or 24hr** appears.
 - l Press ✓ to save the setting.

Creating a fax cover page using the Productivity Studio

- 1 From the desktop, double-click the **Productivity Studio** icon.
- 2 From the Settings area of the Welcome Screen, click **Fax History and Settings**.
- 3 From the toolbar, click **Tools → Cover Pages**.

This screen provides a selection of cover pages and tells you how to change the personal information on the cover page.
- 4 Click **OK** to save your selection.

Blocking junk faxes

- 1 From the desktop, double-click the **Productivity Studio** icon.
- 2 From the Settings area of the Welcome Screen, click **Fax History and Settings**.

The Fax Solution Software appears.
- 3 From the “I Want To” menu, click **Adjust speed dial list and other fax settings**.
- 4 Click the **Ringling and Answering** tab.
- 5 From the “Block Faxes from particular senders/numbers” area, select **Manage Blocked Faxes**.
- 6 If you want to block faxes from senders missing a valid Caller ID, select the check box, and enable fax blocking.
- 7 If you want to block faxes from specific fax numbers, list them in the box provided. You can also edit this list.
- 8 Click **OK** to save the setting.

Blocking unwanted changes to fax settings



This feature blocks network users from changing fax settings.

- 1 From the control panel, press **Settings**.
- 2 Press ◀ or ▶ repeatedly until **Device Setup** appears.
- 3 Press ✓.
- 4 Press ◀ or ▶ repeatedly until **Host Fax Settings** appears.
- 5 Press ✓.
- 6 Press ◀ or ▶ until **Block** appears.
- 7 Press ✓.

Using the Fax Solutions Software

Use this software to adjust how faxes are sent and received. When you save the settings, they apply to every fax you send or receive. You can also use this software to create and edit the Speed Dial list.

- 1 Open the program through one of these methods:

Method 1	Method 2
<p>a Do one of the following:</p> <ul style="list-style-type: none"> • In Windows Vista, click . • In Windows XP and earlier, click Start. <p>b Click Programs or All Programs → Lexmark 6500 Series.</p> <p>c Click Fax Solutions.</p>	<p>a Do one of the following:</p> <ul style="list-style-type: none"> • In Windows Vista, click . • In Windows XP and earlier, click Start. <p>b Click Programs or All Programs → Lexmark 6500 Series.</p> <p>c Click Productivity Studio. The Productivity Studio screen appears.</p> <p>d Click the Fax icon.</p>

- 2 When the Fax Solutions Software appears, as shown, use the “I Want To” menu to:

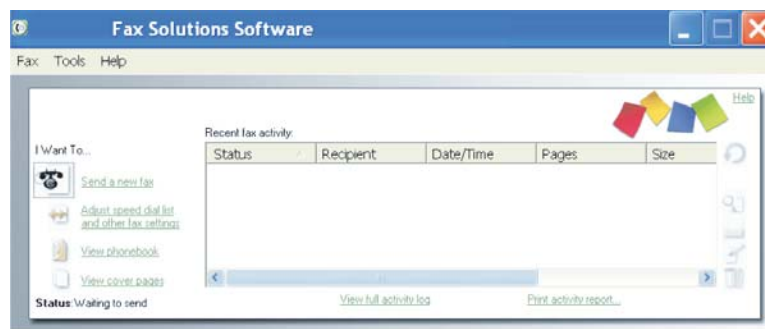

- Send a fax.
- Adjust the Speed Dial list and other fax settings.
- View and use the Phonebook, so you can add new contacts or groups, edit or delete contacts or groups, and add contacts or groups to Speed Dial lists.
- View several sample cover pages that you can choose from. You can also add your company logo to a sample cover page.

3 To access any of the items in the “I Want To” menu, click the item.

4 If needed, click the toolbar items to:

Click	To
Fax	<ul style="list-style-type: none">• Send a fax.• Forward a fax.• View, print, or modify a fax.• Delete a fax.• Retry to send a fax.
Tools	<ul style="list-style-type: none">• Access and use the Phonebook.• View several sample cover pages you can choose from.• View a fax history.• Change software preferences for fax lists.• Adjust fax settings.
Help	Locate information on faxing, fax settings, and so on.

For information on changing fax settings, see “Customizing settings using the Fax Setup Utility” on page 120

5 After changing settings, click **OK**.

6 Close the Fax Solutions Software.

Setting up a dialing prefix

You can add a prefix to the beginning of each fax number dialed. The prefix can include up to eight numbers, commas, periods, spaces, and/or these symbols: * # + - ().

1 From the desktop, double-click the **Productivity Studio** icon.

2 From the Settings area in the Welcome Screen, click **Fax History and Settings**.

3 From the “I Want To” menu, click **Adjust speed dial list and other fax settings**.

4 Click the **Dialing and Sending** tab.

5 Enter the prefix to be dialed before each telephone number.

6 Click **OK** to save the setting.

Setting the distinctive ring

Distinctive ring is a service provided by some telephone companies that assigns multiple phone numbers to a single telephone line. If you subscribe to this service, you can program your printer to have a distinctive ring pattern and phone number for incoming faxes.

1 From the desktop, double-click the **Productivity Studio** icon.

2 From the Settings area of the Welcome Screen, click **Fax History and Settings**.

3 From the “I Want To” menu, click **Adjust speed dial list and other fax settings**.

4 Click the **Ringling and Answering** tab.

- 5 From the “Answering on your phone line type” area, select the setting you want from the “Distinctive ring pattern” drop-down list.
- 6 Click **OK** to save the setting.

Setting the number of rings before receiving a fax automatically

- 1 From the desktop, double-click the **Productivity Studio** icon.
- 2 From the Welcome Screen, click **Fax History and Settings**.
- 3 From the “I Want To” menu, click **Adjust speed dial list and other fax settings**.
- 4 Click the **Ringling and Answering** tab.
- 5 From the “Pick-up on the” drop-down list, select the setting you want.
- 6 From the Auto Answer drop-down list, select **On**.
- 7 Click **OK** to save the setting.

The Auto Answer light on the control panel comes on. When the number of rings you set is detected, the printer automatically receives the incoming fax.

Setting up Speed Dial

- 1 From the desktop, double-click the **Productivity Studio** icon.
- 2 From the Settings area of the Welcome Screen, click **Fax History and Settings**.
- 3 From the “I Want To” menu, click **Adjust speed dial list and other fax settings**.
- 4 Click the **Speed Dial** tab.
- 5 To add a fax number to your Speed Dial list:
 - a Click the next empty line in the list.
 - b Type in a fax number.
 - c Place the cursor in the Contact Name field.
 - d Type in a contact name.
 - e Add fax numbers as needed, following the steps above, on lines 2–89.
- 6 To add a fax group:
 - a Scroll down and click line 90.
A new entry box appears.
 - b Click the next empty line in the list.
 - c Enter up to 30 fax numbers for the group.
 - d Place the cursor in the Contact Name field.
 - e Type in a contact name.
 - f Repeat these steps to add additional groups using lines 91–99 as necessary.
- 7 Click **OK** to save the entries.

Notes:

- You can include a calling card number as part of the fax number.
- A fax number can include up to 64 numbers, commas, periods, spaces, and/or these symbols: * # + - ().

Printing fax activity reports

- 1 From the desktop, double-click the **Productivity Studio** icon.
- 2 From the Settings area of the Welcome Screen, click **Fax History and Settings**.
The Fax Solution Software appears.
- 3 On the toolbar, click **Tools → Fax History**.
- 4 Click the **Print Report** button to print.

Maintaining the printer

Removing a used print cartridge

1 Make sure the printer is on.

2 Lift the scanner unit.

The print cartridge carrier moves and stops at the loading position, unless the printer is busy.

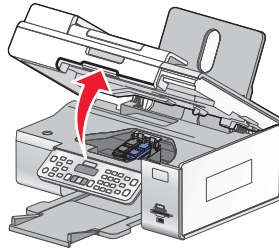

3 Press down on the cartridge carrier latch to raise the cartridge carrier lid.

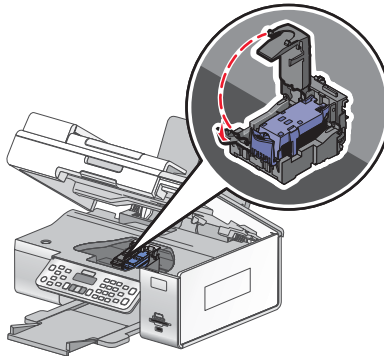

4 Remove the used print cartridge.

Note: If you are removing both cartridges, repeat step 3 and step 4 for the second cartridge.

Installing print cartridges

1 Open the printer.

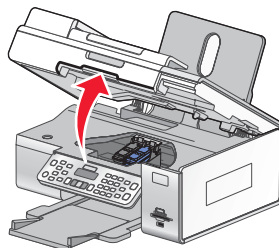

2 Press down on the cartridge carrier levers.

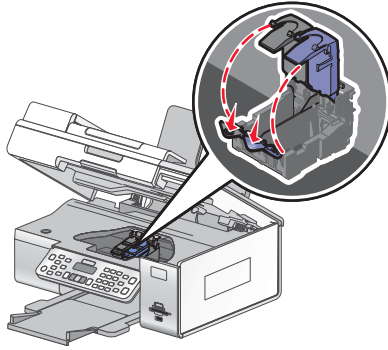

3 Remove the used print cartridge or cartridges. For more information, see “Removing a used print cartridge” on page 130.

4 If you are installing new print cartridges, remove the tape from the back and bottom of the black cartridge, and insert the cartridge in the left carrier.

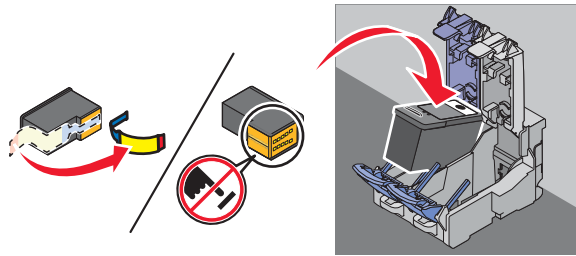

Warning: Do *not* touch the gold contact area on the back or the metal nozzles on the bottom of the cartridge.

5 Close the black cartridge carrier lid.

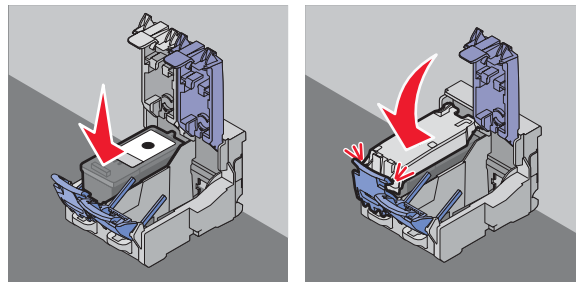

6 Remove the tape from the back and bottom of the color cartridge, and insert the cartridge in the right carrier.

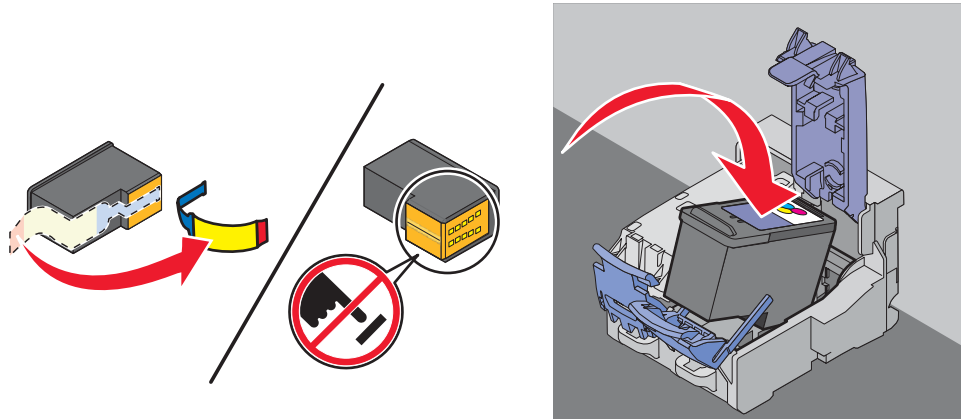

Warning: Do *not* touch the gold contact area on the back or the metal nozzles on the bottom of the cartridge.

7 Close the color cartridge carrier lid.

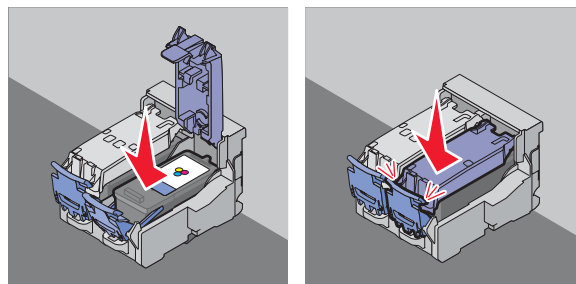

8 Close the printer, making sure to keep your hands out from underneath the scanner unit.

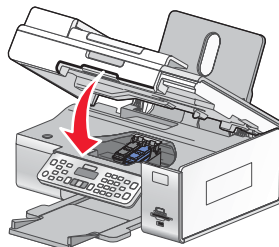

The control panel display will prompt you to load paper and press **✓** to print an alignment page.

Note: The printer must be closed to start a new scan, print, or copy job.

Refilling print cartridges

The warranty does not cover repair of failures or damage caused by a refilled cartridge. Lexmark does not recommend use of a refilled cartridge. Refilling a cartridge can affect print quality and may cause damage to the printer. For best results, use Lexmark supplies.

Using genuine Lexmark print cartridges

Lexmark printers, print cartridges, and photo paper are designed to perform together for superior print quality.

If you receive an **Out of Original Lexmark Ink** message, the original Lexmark ink in the indicated cartridge (s) has been depleted.

If you believe you purchased a new, genuine Lexmark print cartridge, but the **Out of Original Lexmark Ink** message appears:

- 1 Click **Learn More** on the message.
- 2 Click **Report a non-Lexmark print cartridge**.

To prevent the message from appearing again for the indicated cartridge(s):

- Replace your cartridge(s) with new Lexmark print cartridge(s).
- If you are printing from a computer, click **Learn more** on the message, select the check box, and click **Close**.
- If you are using the printer without a computer, press **Cancel**.

Lexmark's warranty does not cover damage caused by non-Lexmark ink or print cartridges.

Aligning print cartridges

- 1 Load plain paper.
- 2 From the control panel, press **Settings**.
- 3 Press ◀ or ▶ repeatedly until **Maintenance** appears.
- 4 Press ✓.
- 5 Press ◀ or ▶ repeatedly until **Align Cartridges** appears.
- 6 Press ✓.

An alignment page prints.

If you aligned the cartridges to improve print quality, print your document again. If print quality has not improved, clean the print cartridge nozzles.

Cleaning the print cartridge nozzles

- 1 Load plain paper.
- 2 Press **Settings**.
- 3 Press ◀ or ▶ repeatedly until **Maintenance** appears.
- 4 Press ✓.
- 5 Press ◀ or ▶ repeatedly until **Clean Cartridges** appears.
- 6 Press ✓.

A page prints, forcing ink through the print cartridge nozzles to clean them.

- 7 Print the document again to verify that the print quality has improved.
- 8 If print quality has not improved, try cleaning the nozzles up to two more times.

Wiping the print cartridge nozzles and contacts

- 1 Remove the print cartridges.
- 2 Dampen a clean, lint-free cloth with water, and place the cloth on a flat surface.

3 Gently hold the nozzles against the cloth for about three seconds, and then wipe in the direction shown.

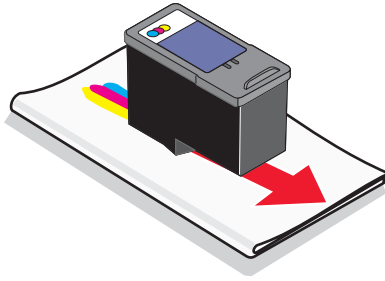

4 Using another clean section of the cloth, gently hold the cloth against the contacts for about three seconds, and then wipe in the direction shown.

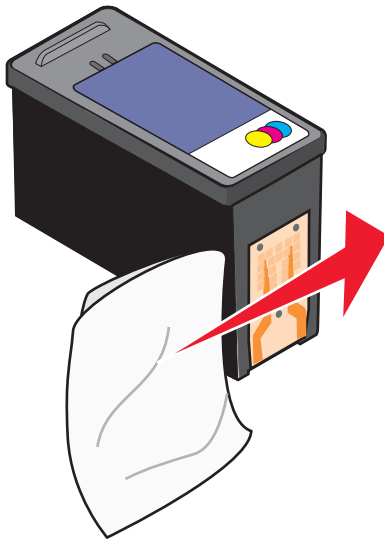

5 With another clean section of the cloth, repeat step 3 and step 4.

6 Let the nozzles and contacts dry completely.

7 Reinsert the print cartridges.

8 Print the document again.

9 If the print quality does not improve, clean the print nozzles. For more information, see “Cleaning the print cartridge nozzles” on page 133.

10 Repeat step 9 up to two more times.

11 If print quality is still not satisfactory, replace the print cartridges.

Preserving the print cartridges

- Keep a new cartridge in its packaging until you are ready to install it.
- Do not remove a cartridge from the printer except to replace, clean, or store it in an airtight container. The cartridges do not print correctly if left exposed for an extended period of time.

- Keep the photo cartridge in its own storage unit when not in use.

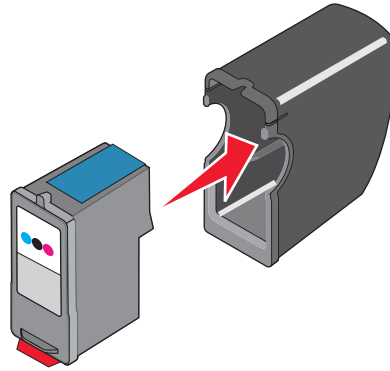

Cleaning the scanner glass

- 1 Dampen a clean, lint-free cloth with water.
- 2 Gently wipe the scanner glass clean.

Note: Make sure all ink or corrective fluid on a document is dry before placing the document on the scanner glass.

Cleaning the exterior of the printer

- 1 Make sure that the printer is turned off and unplugged from the wall outlet.

⚠ CAUTION: To avoid the risk of electric shock, unplug the power cord from the wall outlet and disconnect all cables to the printer before proceeding.

- 2 Remove paper from the paper support and paper exit tray.
- 3 Dampen a clean, lint-free cloth with water.

Warning: Do not use household cleaners or detergents, as they may damage the finish of the printer.

- 4 Wipe only the outside of the printer, making sure to remove any ink residue that has accumulated on the paper exit tray.

Warning: Using a damp cloth to clean the interior may cause damage to your printer.

- 5 Make sure the paper support and paper exit tray are dry before beginning a new print job.

Ordering supplies

Ordering print cartridges

Lexmark 6500 Series models

Item	Part number	Average cartridge standard page yield is up to ¹
Black cartridge	42A	220
Black cartridge ²	42	220
High yield black cartridge	44	500

¹ Values obtained by continuous printing. Declared yield value in accordance with ISO/IEC 24711.

² Licensed Return Program Cartridge

Item	Part number	Average cartridge standard page yield is up to ¹
Color cartridge	41A	210
Color cartridge ²	41	210
High yield color cartridge	43	350
Photo cartridge	40	Not applicable
¹ Values obtained by continuous printing. Declared yield value in accordance with ISO/IEC 24711. ² Licensed Return Program Cartridge		

Ordering paper and other supplies

To order supplies or to locate a dealer near you, visit our Web site at www.lexmark.com.

Notes:

- For best results, use only Lexmark print cartridges.
- For best results when printing photos or other high-quality images, use Lexmark Photo Paper or Lexmark Perfectfinish™ Photo Paper. Do *not* use Lexmark Premium Photo Paper. Your print cartridges are not compatible with this type of paper.
- To prevent smudging or scratching, avoid touching the printed surface with your fingers or sharp objects. For best results, remove each printed sheet individually from the paper exit tray, and allow the sheets to dry at least 24 hours before stacking, displaying, or storing.

Item	Part Number
USB cable	1021294
Lexmark N2050 (Internal wireless print server) Note: If your printer did not come with an internal wireless print server already installed, installing the Lexmark N2050 in the printer lets you print and scan on a wireless network.	For more information, go to www.lexmark.com .
For more information, go to www.lexmark.com	

Paper	Paper size
Lexmark Photo Paper	<ul style="list-style-type: none"> • Letter • A4 • 4 x 6 in. • 10 x 15 cm
Lexmark PerfectFinish Photo Paper	<ul style="list-style-type: none"> • Letter • A4 • 4 x 6 in. • 10 x 15 cm • L
Note: Availability may vary by country or region.	

For information on how to purchase Lexmark Photo Paper or Lexmark PerfectFinish Photo Paper in your country or region, go to www.lexmark.com.

Troubleshooting

If you set up your printer on a wireless network, make sure:

- The wireless network is working properly.
- The computer and printer are both connected to the same wireless network.
- The printer is within the range of the wireless network. The effective range for optimal performance is generally 100–150 feet.
- The printer is located away from other electronic devices that may interfere with the wireless signal.
- The power supply is connected to the printer, and  is lit.
- The Wi-Fi indicator light is green.
- The printer driver is installed on the computer from which you are performing a task.
- The correct printer port is selected.

Setup Troubleshooting

Incorrect language appears on the display

These are possible solutions. Try one of the following:

Change the language selection during initial setup

After you select a language, **L**anguage appears again on the display. To change the selection:

- 1 Press ◀ or ▶ repeatedly until the language you want appears on the display.
- 2 Press ✓ to save.

Select a different language after initial setup

- 1 From the control panel, press **Settings**.
- 2 Press ◀ or ▶ repeatedly until **Device Setup** appears.
- 3 Press ✓.
- 4 Press ◀ or ▶ repeatedly until **L**anguage appears.
- 5 Press ✓.
- 6 Press ◀ or ▶ repeatedly until the language you want appears on the display.
- 7 Press ✓.
- 8 Press ◀ or ▶ until **Yes** appears.
- 9 Press ✓ to save.

Note: If you cannot understand the language on the display, see “Resetting the printer to factory default settings” on page 172.

Power button is not lit

These are possible solutions. Try one or more of the following:



Press power button

Make sure the printer is on by pressing  .

Disconnect and reconnect the power cord

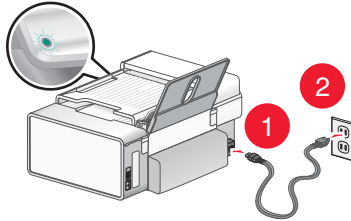
- 1 Disconnect the power cord from the wall outlet, and then from the printer.
- 2 Plug the cord all the way into the power supply on the printer.



- 3 Plug the cord into an electrical outlet that other electrical devices have been using.
- 4 If the  light is not on, press .

Software does not install

These are possible solutions. Try one or more of the following:

Check your operating system

The following operating systems are supported:

- Windows Vista
- Windows XP
- Windows 2000 with Service Pack 3 or later
- Mac OS X

Check your system requirements

Check that your computer meets the minimum system requirements listed on the printer box.

Check your USB connection

Follow these steps if you are not using the printer on a wireless network:

- 1 Check the USB cable for any obvious damage.
- 2 Firmly plug the square end of the USB cable into the back of the printer.
- 3 Firmly plug the rectangular end of the USB cable into the USB port of the computer.

The USB port is marked with the  USB symbol.

Reconnect the power supply

- 1 Press  to turn the printer off.
- 2 Disconnect the power cord from the wall outlet.

- 3 Gently remove the power supply from the printer.
- 4 Reconnect the power supply to the printer.
- 5 Plug the power cord into the wall outlet.
- 6 Press  to turn the printer on.

Uninstall and reinstall software

Uninstall the printer software, and then reinstall it. For more information, see “Removing and reinstalling the software” on page 141.

Page does not print

These are possible solutions. Try one or more of the following:

Check messages

If an error message is displayed, see “Error messages on the computer screen” on page 197.

Check power

If the  light is not on, see “Power button is not lit” on page 138.

Reload paper

Remove and then load paper.

Check ink

Check the ink levels, and install new print cartridges if necessary.

Check cartridges

- 1 Remove the print cartridges.
- 2 Make sure the sticker and tape have been removed.

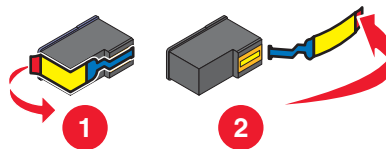

- 3 Reinsert the cartridges.



Check printer default and pause settings

- 1 Click:
 - In Windows Vista:  → **Control Panel** → **Printers** (under Hardware and Sound).
 - In Windows XP: **Start** → **Printers and Faxes**.
 - In Windows 2000: **Start** → **Settings** → **Printers**.
- 2 Double-click the printer queue device.

3 Click **Printer**.

- Make sure no check mark appears next to Pause Printing.
- If a check mark does not appear next to Set As Default Printer, you must select the print queue device for each file you want to print.

Reconnect power supply

- 1 Press  to turn the printer off.
- 2 Disconnect the power cord from the wall outlet.
- 3 Gently remove the power supply from the printer.
- 4 Reconnect the power supply to the printer.
- 5 Plug the power cord into the wall outlet.
- 6 Press  to turn the printer on.

Removing and reinstalling the software

Uninstall the printer software, and then reinstall it. For more information, see “Removing and reinstalling the software” on page 141.

Cannot print from digital camera using PictBridge

These are possible solutions. Try one or more of the following:

Enable PictBridge printing from camera

Enable PictBridge printing on the camera by selecting the correct USB mode. For more information, see the digital camera documentation.

Make sure the camera is a PictBridge-enabled digital camera

- 1 Disconnect the camera.
- 2 Connect a PictBridge-enabled digital camera to the PictBridge port. See the digital camera documentation to determine whether it is PictBridge-enabled.

Check USB cable

Use only the USB cable that came with the camera.

Remove memory cards

Remove any memory cards from the printer.

Check messages

If an error message appears on the display, see “Error messages on the computer screen” on page 197.

Understanding Warning levels

- A green check indicates system requirements were met.
- A yellow question mark indicates system requirements were not met. Most major functions will work, but you may experience some performance impact.
- A red question mark indicates system requirements were not met. Most major functions may not work.
- A red X indicates system requirements were not met. Installation will not continue.

For proper installation, make sure the computer supports all system requirements. System requirements are located on the printer box.

Removing and reinstalling the software

If the printer is not functioning properly, or if a communications error message appears when you try to use the printer, you may need to remove and reinstall the printer software.

- 1 Click **Start → Programs** or **All Programs → Lexmark 6500 Series**.
- 2 Select **Uninstall**.
- 3 Follow the instructions on the computer screen to remove the printer software.
- 4 Restart the computer before reinstalling the printer software.
- 5 Click **Cancel** on all New Hardware Found screens.
- 6 Insert the CD, and then follow the instructions on the computer screen to reinstall the software.

Note: If the install screen does not appear automatically after you restart your computer, click **Start → Run**, and then type **D:\setup**, where **D** is the letter of your CD-ROM drive.

If the software still does not install correctly, visit our Web site at www.lexmark.com to check for the latest software.

- 1 In all countries or regions except the United States, select your country or region.
- 2 Click the links for drivers or downloads.
- 3 Select your printer family.
- 4 Select your printer model.
- 5 Select your operating system.
- 6 Select the file you want to download, and then follow the directions on the computer screen.

Enabling the USB port

To confirm that the USB port is enabled on the computer:

- 1 In Windows Vista, click  → **Control Panel**.
In Windows XP, click **Start → Control Panel**.
In Windows 2000, click **Start → Settings → Control Panel**.
- 2 If you are using Windows Vista, click the **System and Maintenance** icon, and then click **Device Manager**.
If you are using Windows XP or Windows 2000:
 - a Click **Performance and Maintenance**, and then click the **System** icon.
 - b Click the **Hardware** tab.
 - c Click **Device Manager**.
- 3 Click the plus sign (+) beside **Universal Serial Bus Controller**.
If USB Host Controller and USB Root Hub are listed, the USB port is enabled.

Did you find the problem?

Yes

If USB Host Controller and USB Root Hub are *not* listed, the USB port is *not* enabled. For more information, see the computer documentation.

No

Contact the Customer Support Center.

- 1 Click **Start → Programs** or **All Programs → Lexmark 6500 Series**.
- 2 Click **Solution Center**.
- 3 Click the **Contact Information** tab.

Solving printer communication problems

The printer and the computer cannot exchange data.

These are possible solutions. Try one or more of the following:

Establish bidirectional communication between the printer and the computer

For more information, see “Bidirectional communication is not established” on page 170.

Make sure the printer is not in sleep mode

If the power light is blinking on and off slowly, the printer is in sleep mode.

- 1 Unplug the power cable from the wall outlet.
- 2 Wait ten seconds, and then insert the power cable into the wall outlet.
- 3 Press  to turn the printer on.

Wireless troubleshooting

How do I find out what type of security my network is using?

You must know the security key and security mode in order to properly set up the printer for use on the wireless network. To obtain this information, see the documentation that came with your wireless router, see the Web page associated with the router, or consult the person who set up your wireless network.

Check your security keys

A security key is like a password. All devices on the same network share the same security key.

Note: Make sure you copy down the security key exactly, including any capital letters, and store it in a safe place for future reference.

The security key must follow the following criteria.

WEP key

- Exactly 10 or 26 hexadecimal characters. Hexadecimal characters are A–F and 0–9.
- Exactly 5 or 13 ASCII characters. ASCII characters are letters, numbers, and symbols found on a keyboard.

WPA-PSK or WPA2-PSK key

- Up to 64 hexadecimal characters. Hexadecimal characters are A–F and 0–9.
- Between 8 and 64 ASCII characters. ASCII characters are letters, numbers, and symbols found on a keyboard.

Printer is configured correctly, but cannot be found on the network

Make sure:

- The printer has power and the  light is on.
- The printer is within range of the wireless network.
- The printer is located away from other electronic devices that may interfere with the wireless signal.
- Your wireless network is using a unique network name (SSID). If not, it is possible that the printer/print server is communicating over a different, nearby network that uses the same network name.
- The printer has a valid IP address on the network.

Wireless network printer does not print

These are possible solutions. Try one or more of the following:

Check power

Make sure the  light is on.

Check cable

- Make sure the power cable is connected to the printer and to the electrical outlet.
- Make sure the USB cable or the installation cable is not connected.

Check Wi-Fi indicator light

Make sure the Wi-Fi indicator light is green. If it is not green, see “Wi-Fi indicator light is orange” or “Wi-Fi indicator light is blinking orange during installation” in “Wireless troubleshooting.”

Check if printer driver is installed

Make sure the printer driver is installed on the computer from which you are sending the print job.

1 Do one of the following:

- In Windows Vista, click:  → **Control Panel** → **Printers**.
- In Windows XP, click: **Start** → **Settings** → **Printers and Faxes**.
- In Windows 2000 and earlier, click: **Start** → **Settings** → **Printers**.

If you cannot find the icon for your printer, then the printer driver is not installed.

2 If the printer driver is not installed, insert the installation software CD into your computer.

3 Follow the instructions on the computer screen.

Note: You must install the printer driver on each computer that uses the network printer.

Check if printer is connected to the wireless network

- 1** Print a network setup page. For more information, see “Printing a network setup page.”
- 2** Check to see if “Status: Connected” appears under Network Card.

Reboot the computer

Turn off and restart the computer.

Check printer ports

Make sure the correct printer port is selected.

1 Click:

- In Windows Vista:  → **Control Panel** → **Printers**.
- In Windows XP: **Start** → **Settings** → **Printers and Faxes**.
- In Windows 2000 and earlier: **Start** → **Settings** → **Printers**.

2 Right-click the **Lexmark 6500 Series** icon.

3 Click **Properties** → **Ports**.

4 Verify that **XXXX_Series_nnnnnn_P1** is selected, where XXXX is the model series number of your printer and nnnnnn is the last six numbers of the MAC address of your printer.

Note: The MAC address is located at the back of the printer beside the serial number.

5 If **USB** is selected instead:

- a Select the port name from step 4.
- b Click **Apply**.
- c Close the window, and try printing again.

Reinstall software

Uninstall and then reinstall the printer software.

Note: If more than one printer appears in the "Select your printer" list, pick the printer with the MAC address that matches the address on the back of your printer.

Network printer does not show up in the printer selection list during installation

Check whether the printer is on the same wireless network as the computer

The SSID of the printer must match the SSID of the wireless network.

1 If you do not know the SSID of the network, use the following steps to obtain it before rerunning the Wireless Setup Utility.

- a Enter the IP address of your wireless access point (wireless router) into the Web address field of your browser.

If you do not know the IP address of the wireless access point (wireless router):

1 Do one of the following:

- In Windows Vista, click  → **All Programs** → **Accessories** → **Command Prompt**.
- In Windows XP, click **Start** → **Programs** or **All Programs** → **Accessories** → **Command Prompt**.

2 Type **ipconfig**.

3 Press **Enter**.

- The "Default Gateway" entry is typically the wireless access point (wireless router).
- The IP address appears as four sets of numbers separated by periods, such as 192.168.0.100.

- b Enter your user name and password when prompted.

- c Click **OK**.

- d On the main page, click **Wireless** or any other selection where settings are stored. The SSID will be displayed.
- e Write down the SSID, security type, and the security keys if they are shown.

Note: Make sure you copy them down exactly, including any capital letters.

2 Click **Start → Programs** or **All Programs → Lexmark 6500 Series**.

3 Click **Wireless Setup**.

Note: You may be prompted to connect the printer to the computer again using the installation cable as part of the setup process.

4 Follow the instructions on the computer screen, including typing in the SSID of the wireless access point (wireless router) and the security keys when prompted.

5 Store the SSID and the security keys in a safe place for future reference.

Wi-Fi indicator is not lit

These are possible solutions. Try one or more of the following:

Check power

Make sure the printer power light is on. For more information, see “Power button is not lit”.

Remove and reinstall the optional internal print server

Note: This solution does *not* apply to printers that came with the internal wireless print server already installed.

Reinstall the internal wireless print server. For more information, see “Installing an optional internal wireless print server”.

Wi-Fi indicator light is blinking orange during installation

When the Wi-Fi indicator light is blinking orange, it indicates that the printer has been set up for wireless networking but cannot connect to the network for which it has been configured. The printer may be unable to join the network because of interference or its distance from the wireless access point (wireless router), or until its settings are changed.

These are possible solutions. Try one or more of the following:

Make sure the access point is on

Check the access point and, if necessary, turn it on.

Move your wireless access point (wireless router) to minimize interference

There may be temporary interference from other devices such as microwave ovens or other appliances, cordless phones, baby monitors, and security system cameras. Make sure your wireless access point (wireless router) is not positioned too closely to these devices.

Try adjusting external antennas

Generally, antennas work best if they are pointing straight up. You may find, however, that reception improves if you experiment with different angles for your printer and/or wireless access point (wireless router) antennas.

Move your computer and/or printer

Move the computer and/or printer closer to the wireless access point (wireless router). Although the possible distance between devices in 802.11b or 802.11g networks is 300 feet, the effective range for optimal performance is generally 100–150 feet.

You can find the signal strength of the network on the network setup page. For information on how to print a setup page, see “Printing a network setup page” on page 52.



Check security keys

Make sure security keys are correct. For more information, see “Check your security keys” on page 142.

Check MAC address

If your network uses MAC address filtering, provide the MAC address for the printer to your network. If you need help finding the MAC address, see “Finding the MAC address” on page 51.

Ping the wireless access point (wireless router) to make sure the network is working

- 1 If you do not already know it, find the IP address of the access point.
 - a Click:
 - In Windows Vista:  → **All Programs** → **Accessories** → **Command Prompt**.
 - In Windows XP and earlier: **Start** → **Programs** or **All Programs** → **Accessories** → **Command Prompt**.
 - b Type **ipconfig**.
 - c Press **Enter**.
 - The “Default Gateway” entry is typically the wireless access point (wireless router).
 - The IP address appears as four sets of numbers separated by periods, such as 192.168.0.100. Your IP address might also start with the numbers 10 or 169. This is determined by your operating system or wireless network software.
- 2 Ping the wireless access point (wireless router).
 - a Click:
 - In Windows Vista:  → **All Programs** → **Accessories** → **Command Prompt**.
 - In Windows XP and earlier: **Start** → **Programs** or **All Programs** → **Accessories** → **Command Prompt**.
 - b Type **ping** followed by a space and the IP address of the wireless access point (wireless router). For example:

```
ping 192.168.0.100
```
 - c Press **Enter**.
- 3 If the wireless access point (wireless router) responds, you will see several lines appear that start with “Reply from”. Turn off and restart the printer.
- 4 If the wireless access point (wireless router) does not respond, it will take several seconds and then you will see “Request timed out.”

Try the following:

- a Click:
 - In Windows Vista:  → **Control Panel** → **Network and Internet** → **Network and Sharing Center**
 - In Windows XP and earlier: **Start** → **Settings** or **Control Panel** → **Network Connection**
- b Select the appropriate connection from the ones shown.

Note: If the computer is connected to the access point (router) by an Ethernet cable, the connection may not include the word “wireless” in its name.
- c Right-click the connection, and then click **Repair**.

Run the wireless setup again

If your wireless settings have changed, you must run the printer wireless setup again. Some reasons your settings may have changed include your having manually changed your WEP or WPA keys, channel, or other network settings; or the wireless access point (wireless router) having been reset to factory defaults.

Notes:

- If you change network settings, change them on all the network devices before changing them for the wireless access point (wireless router).
- If you have already changed the wireless network settings on your wireless access point (wireless router), you must change the settings on all the other network devices before you can see them on the network.

1 Click:

- In Windows Vista: .
- In Windows XP and earlier: Start.

2 Click **Start** → **Programs** or **All Programs** → **Lexmark 6500 Series**.

3 Click **Wireless Setup**.

Note: You may be prompted to connect the printer to the computer again using the installation cable as part of the setup process.

4 Follow the instructions on the computer screen.

Wi-Fi indicator light is orange

These are possible solutions. Try one or more of the following:

Check cable

Make sure the installation cable is not connected to the printer.

Configure the optional internal wireless print server

Note: This solution does not apply to printers that have a pre-installed internal wireless print server.

If you purchased the optional internal wireless print server after your printer was already set up, see “Configuring the optional internal wireless print server” in the “Setting up the printer” chapter.

Check network name

Make sure your network does not have the same name as another network near you. For example, if you and your neighbor both use a manufacturer's default network name, your printer could be connecting to your neighbor's network.

If you are not using a unique network name, consult the documentation for your wireless access point (wireless router) to learn how to set a network name.

If you set a new network name, you must reset the printer and computer SSID to the same network name.

For more information, see “Checking your network name” in the “Wireless troubleshooting” section.

Check security keys

Make sure security keys are correct. For more information, see “Check your security keys” on page 142.

Move your computer and/or printer

Move the computer and/or printer closer to the wireless access point (wireless router). Although the possible distance between devices in 802.11b or 802.11g networks is 300 feet, the effective range for optimal performance is generally 100–150 feet.

You can find the signal strength of the network on the network setup page. For information on how to print a setup page, see “Printing a network setup page” on page 52.

Check MAC address

If your network uses MAC address filtering, provide the MAC address for the printer to your network. If you need help finding the MAC address, see “Finding the MAC address” on page 51.

Wireless printer is no longer working

These are possible solutions. Try one or more of the following:

Check power

- Make sure the printer power light is on. For more information, see “Power button is not lit” in the “Troubleshooting” chapter.
- Make sure the wireless access point (wireless router) is on.

Move your wireless access point (wireless router) to minimize interference

There may be temporary interference from other devices such as microwaves or other appliances, cordless phones, baby monitors, and security system cameras. Make sure your wireless access point (wireless router) is not positioned too closely to these devices.

Move your computer and/or printer

Move the computer and/or printer closer to the wireless access point (wireless router). Although the possible distance between devices in 802.11b or 802.11g networks is 300 feet, the effective range for optimal performance is generally 100–150 feet.

You can find the signal strength of the network on the network setup page. For more information, see “Printing a network setup page” in the “Networking” chapter.

Try adjusting external antennas

Generally, antennas work best if they are pointing straight up. You may find, however, that reception improves if you experiment with different angles for your printer and/or wireless access point (wireless router) antennas.

Check network name

The network name, or SSID (Service Set Identifier) is a setting on a wireless device that allows devices to join the same wireless network.

For more information, see “Checking your network name” for Windows or Mac in the “Wireless troubleshooting” section.

Reboot the computer

Turn off and restart the computer.

Ping the wireless access point

Ping the wireless access point (wireless router) to make sure the network is working.

For more information, see “Ping the access point” for Windows or Mac in the “Wireless troubleshooting” section

Ping the printer

Ping the printer to make sure it is on the network.

For more information, see “Ping the printer” for Windows or Mac in the “Wireless troubleshooting” section.

Run the wireless setup again

If your wireless settings have changed, you will need to run the printer wireless setup again. Some reasons your settings may have changed include your having manually changed your WEP or WPA keys, channel, or other network settings, or the wireless access point (wireless router) having been reset to factory defaults.

Notes:

- If you change network settings, change them on all the network devices before changing them for the wireless access point (wireless router).
- If you have already changed the wireless network settings on your wireless access point (wireless router), you must change the settings on all the other network devices before you can see them on the network.

For more information, see “Run the Wireless Setup Utility” for Windows or “Run the Wireless Setup Assistant” for Mac.

Changing wireless settings after installation

To change your password, network name, or other wireless setting, rerun the wireless setup. For more information, see “Run the Wireless Setup Utility” for Windows or the “Run the Wireless Setup Assistant” for Mac.

Resetting an internal wireless print server to factory default settings

You may need to select a different wireless network during the installation process.

1 Press **Settings**.

2 Press ◀ or ▶ repeatedly until **Network Setup** appears.

3 Press ✓.

4 Press ◀ or ▶ repeatedly until **wireless Setup** appears.

5 Press ✓.

6 Press ◀ or ▶ repeatedly until **Reset Network Adapter to Factory Default** appears.

7 Press ✓.

The following message appears: **This will reset all wireless network settings. Are you sure?**

8 Press ◀ or ▶ repeatedly until **Yes** appears.

9 Press ✓.

Clearing wireless settings appears.

Notes:

- It may take 30-60 seconds for the settings to be cleared.
- The Wi-Fi indicator light will turn to orange.

Printer cannot connect to the wireless network

These are possible solutions. Try one or more of the following:

Make sure your computer is connected to your wireless access point (wireless router)

- See whether you have access to the Internet by opening your Web browser and accessing any site.
- If there are other computers or resources on your wireless network, check to see if you can access them from your computer.

Move the computer and/or printer closer to the wireless router

Although the possible distance between devices in 802.11b or 802.11g networks is 300 feet, the effective range for optimal performance is generally 100–150 feet.

Try setting up the printer again by rerunning the Wireless Setup Utility.

1 Select one of the following:

- In Windows Vista, click .
- In Windows XP and earlier: Click **Start**.

2 Click **Start** → **Programs** or **All Programs** → **Lexmark 6500 Series**.

3 Click **Wireless Setup**.

Note: You may be prompted to connect the printer to the computer again using the installation cable as part of the setup process.

4 Follow the instructions on the computer screen.

Check whether the printer is on the same wireless network as the computer

The SSID of the printer must match the SSID of the wireless network.

If you do not know the SSID of the network, use the following steps to obtain it, and then rerun the Wireless Setup Utility to set up the printer again.

1 Enter the IP address of your wireless access point (wireless router) into your browser's Web address field.

If you do not know the IP address of the wireless access point (wireless router):

a Click:

- In Windows Vista:  → **All Programs** → **Accessories** → **Command Prompt**.
- In Windows XP and earlier: **Start** → **Programs** or **All Programs** → **Accessories** → **Command Prompt**.

b Type **ipconfig**.

c Press **Enter**.

- The "Default Gateway" entry is typically the wireless access point (wireless router).
- The IP address appears as four sets of numbers separated by periods, such as 192.168.0.100. Your IP address might also start with the numbers 10 or 169. This is determined by your operating system or wireless network software.

2 Enter your user name and password when prompted.

3 Click **OK**.

4 On the main page, click **Wireless** or other selection where settings are stored. The SSID will be displayed.

5 Write down the SSID, security type, and the security keys if they are shown.

Note: Make sure you copy them down exactly, including any capital letters.

6 Store the SSID and the security keys in a safe place for future reference.

Check your security keys

A security key is like a password. All devices on the same network will share the same security key.

- If you are using the WPA type of security, make sure you entered the correct key. Security keys are case sensitive.
- If you are using the WEP type of security, you should enter the key as a series of digits (0–9) and letters (A–F).

Note: If you do not know this information, see the documentation that came with the wireless network, or contact the person who set up your wireless network.

Check your advanced security settings

- If you are using MAC address filtering to limit access to your wireless network, you must add the printer's MAC address to the list of addresses allowed to connect to your wireless access point (wireless router).
- If you set your wireless access point (wireless router) to issue a limited number of IP addresses, you must change this so that the printer can be added.

Note: If you do not know how to make these changes, see the documentation that came with the wireless network, or contact the person who set up your wireless network.

Wireless Setup Utility cannot communicate with the printer during installation (Windows users only)

These are possible solutions for Windows users. Try one or more of the following:

Check power

If the  light is not on, see “Power button is not lit”.

Check the installation cable

- 1 Disconnect the installation cable and check it for any obvious damage.
- 2 Firmly plug the rectangular end of the USB cable into the USB port of the computer.
The USB port is marked with the  USB symbol.
- 3 Firmly plug the square end of the USB cable into the USB port on the back of the printer.
- 4 Cancel the software installation.
- 5 Click **Start → Programs** or **All Programs → Lexmark 6500 Series**.
- 6 Click **Wireless Setup Utility**.
- 7 Follow the prompts on the computer screen to reinstall the software.

Checking your network name (Windows users only)



Make sure your network does not have the same name as another network near you. For example, if you and your neighbor both use a manufacturer's default network name, your printer could be connecting to your neighbor's network.

If you are not using a unique network name, consult the documentation for your wireless access point (wireless router) to learn how to set a network name.

If you set a new network name, you must reset the printer and computer SSID to the same network name.

- To reset the computer network name, see the documentation that came with your computer.
- To reset the printer name:
 - 1 Click **Start** → **Programs** or **All Programs** → **Lexmark 6500 Series**.
 - 2 Click **Wireless Setup Utility**.
 - 3 Follow the instructions on the computer screen, and enter the new network name when prompted.

Ping the access point

- 1 If you do not already know it, find the IP address of the wireless access point (wireless router).
 - a Do one of the following:
 - In Windows Vista, click  → **All Programs** → **Accessories** → **Command Prompt**.
 - In Windows XP, click **Start** → **Programs** or **All Programs** → **Accessories** → **Command Prompt**.
 - b Type **ipconfig**.
 - c Press **Enter**.
 - The “Default Gateway” entry is typically the wireless access point (wireless router).
 - The IP address appears as four sets of numbers separated by periods, such as 192.168.0.100.
- 2 Ping the wireless access point (wireless router).
 - a Do one of the following:
 - In Windows Vista, click  → **All Programs** → **Accessories** → **Command Prompt**.
 - In Windows XP, click **Start** → **Programs** or **All Programs** → **Accessories** → **Command Prompt**.
 - b Type **ping** followed by a space and the IP address of the wireless access point (wireless router). For example:

```
ping 192.168.0.100
```
 - c Press **Enter**.
- 3 If the wireless access point (wireless router) responds, you will see several lines appear that start with “Reply from”. Turn off and restart the printer.
- 4 If the wireless access point (wireless router) does not respond, after several seconds you will see “Request timed out.”
 - a Do one of the following:
 - In Windows Vista, click the  → **Control Panel** → **Network and Internet** → **Network and Sharing Center**.
 - In Windows XP, click **Start** → **Settings** or **Control Panel** → **Network Connection**.
 - b Select the appropriate connection from the ones shown.

Note: If the computer is connected to the access point (router) by an Ethernet cable, the connection may not include the word “wireless” in its name.
 - c Right-click the connection, and then click **Repair**.

Ping the printer

- 1 Do one of the following:
 - In Windows Vista, click  → **All Programs** → **Accessories** → **Command Prompt**.
 - In Windows XP, click **Start** → **Programs** or **All Programs** → **Accessories** → **Command Prompt**.

- 2 Type **ping** followed by the IP address of the printer. For example,
`ping 192.168.0.25`
- 3 Press **Enter**.
- 4 If the printer responds, you will see several lines appear that start with “Reply from”.
Turn off and restart the printer, and then try resending your print job.
- 5 If the printer does not respond, you will see “Request timed out.”
 - a Check that the computer has a wireless IP address.
 - 1 Do one of the following:
 - In Windows Vista, click  → **All Programs** → **Accessories** → **Command Prompt**.
 - In Windows XP, click **Start** → **Programs** or **All Programs** → **Accessories** → **Command Prompt**.
 - 2 Type **ipconfig**.
 - 3 Press **Enter**.
 - 4 Check the Windows IP Configuration screen that appears for the wireless IP address of the computer.
Note: Your computer may have an IP address for a wired network, a wireless network, or both.
 - 5 If your computer does not have an IP address, see the documentation that came with your wireless access point (wireless router) to learn how to connect your computer to the wireless network.
 - b The printer may need to be reconfigured for new wireless network settings. For more information, see “Run the Wireless Setup Utility”.

Run the Wireless Setup Utility (Windows users only)

- 1 Click **Start** → **Programs** or **All Programs** → **Lexmark 6500 Series**.
- 2 Click **Wireless Setup Utility**.
Note: You may be prompted to connect the printer to the computer again using the installation cable as part of the setup process.
- 3 Follow the instructions on the computer screen.

Check printer ports (Windows users only)

Make sure the correct printer port is selected.

- 1 Click **Start** → **Control Panel** → **Printers**.
- 2 Right-click **Lexmark XXXX**, where XXXX is the model series number of your printer.
- 3 Click **Properties** → **Ports**.
- 4 Verify that **XXXX_Series_nnnnnn_P1** is selected, where XXXX is the model series number of your printer and nnnnnn is the last six numbers of the MAC address of your printer.
Note: The MAC address is located at the back of the printer beside the serial number.
- 5 If **USB** is selected instead:
 - a Select the port name from step 4.
 - b Click **Apply**.
 - c Close the window, and try printing again.

Print troubleshooting

Partial 4 x 6 in. (10 x 15 cm) photo prints when using a PictBridge-enabled digital camera

Make sure photo size and paper size are set correctly

The printer displays the **Paper/Photo Size Error** when your chosen photo size does not match the paper size that is set. This typically happens when you are trying to print from your PictBridge-enabled digital camera. You may have left the printer control panel Photo Size menu item setting at **8.5 x 11 in.** or **5 x 7 in.** size, but your camera has a print size of **4 x 6 in.** or **L**. You need to make sure your chosen photo size on the printer is **4 x 6 in.** or **10 x 15 cm**, depending on the typically used photo size for your country or region.

- Make sure the 4 x 6 in. (10 x 15 cm) photo paper is loaded correctly in the paper support.
- If your camera lets you change the print size setting, change the print size selection to 4 x 6 in. (10 x 15 cm) on the PictBridge-enabled digital camera.
- If your camera does not allow you to change the paper size setting, use the control panel to change the paper size to 4 x 6 in. (10 x 15 cm).

- 1 Insert the USB cable that came with your camera to the camera, and insert the other end into the PictBridge port on the front of the printer.
- 2 Turn the camera on and choose your first photo using the camera control panel.
- 3 Wait for **PictBridge Printing** to appear on the display of the printer control panel.

Note: If **Paper/Photo Size Error** appears, press **X** to clear the error message.

- 4 Press .
- 5 Press **◀** or **▶** repeatedly until **Photo Size** appears.
- 6 Press **✓**.
- 7 Press **◀** or **▶** repeatedly until **4 x 6 in.** or **10 x 15 cm** appears.
- 8 Press **✓**.
- 9 Press **◀** or **▶** repeatedly until **Paper Setup** appears.
- 10 Press **✓**.
- 11 Press **◀** or **▶** repeatedly until **Paper Size** appears.
- 12 Press **✓**.
- 13 Press **◀** or **▶** repeatedly until **10 x 15 cm** appears.
- 14 Press **✓**.
- 15 Press **Start Color** or **Start Black**.







Improving print quality

These are possible solutions. Try one or more of the following:

Check paper

- Use the appropriate paper for the document. If you are printing photos or other high-quality images, for best results use Lexmark Photo Paper or Lexmark PerfectFinish Photo Paper. Do *not* use Lexmark Premium Photo Paper. Your print cartridges are not compatible with this type of paper.
- Use a paper that is a heavier weight or bright white.

Select a higher print quality

- 1 Depending on your print job, press **Copy Mode**, **Scan Mode**, or **Photo Card**.
- 2 Press .
- 3 Press  or  repeatedly until **Quality** appears.
- 4 Press .
- 5 Press  or  repeatedly until the quality you want appears.
- 6 Press .

Check print cartridges

If the document still does not have the print quality you want, follow these steps:

- 1 Align the print cartridges. For more information, see “Aligning print cartridges” on page 133. If print quality has not improved, continue to the next step.
- 2 Clean the print cartridge nozzles. For more information, see “Cleaning the print cartridge nozzles” on page 133. If print quality has not improved, continue to the next step.
- 3 Install the print cartridges. For more information, see “Installing print cartridges” on page 130.
- 4 Wipe the print nozzles and contacts. For more information, see “Wiping the print cartridge nozzles and contacts” on page 133.

If print quality is still not satisfactory, replace the print cartridges. For more information, see “Ordering supplies” on page 135.

Poor text and graphic quality

- Blank pages
- Dark print
- Faded print
- Incorrect colors
- Light and dark bands in print
- Skewed lines
- Smudges
- Streaks
- White lines in print

These are possible solutions. Try one or more of the following:

Check ink

Check the ink levels, and install new print cartridges if necessary.

Review steps to improve print quality

See “Improving print quality” on page 154.

Remove sheets as they are printed

To avoid ink smudging when you are working with the following media, remove each sheet as it exits, and allow it to dry:

- Documents with graphics or images
- Photo paper
- Heavyweight matte or glossy paper

- Transparencies
- Labels
- Envelopes
- Iron-on transfers

Note: Transparencies may take up to 15 minutes to dry.

Use a different brand of paper

Each paper brand accepts ink differently and prints with color variations. If you are printing photos or other high-quality images, for best results use Lexmark PerfectFinish Photo Paper or Lexmark Photo Paper. Do *not* use Lexmark Premium Photo Paper. Your print cartridges are not compatible with this type of paper.

Check paper condition

Use only new, unwrinkled paper.

Removing and reinstalling the software

Software may not be installed correctly. For more information, see “Removing and reinstalling the software” on page 141.

Poor quality at the edges of the page

These are possible solutions. Try one or more of the following:

Check minimum print settings







Unless you are using the borderless feature, use these minimum print margin settings:

- Left and right margins:
 - 6.35 mm (0.25 in.) for letter-size paper
 - 3.37 mm (0.133 in.) for all paper sizes except letter
- Top margin: 1.7 mm (0.067 in.)
- Bottom margin: 12.7 mm (0.5 in.)

Select the Borderless print feature

- 1 From the software application, click **File → Print**.
- 2 Click **Properties, Preferences, Options, or Setup**.
- 3 Click **Print Layout**.
- 4 Click **Borderless**.

Select the Borderless resize feature (when copying)

- 1 Press .
- 2 Press  or  repeatedly until **Resize** appears.
- 3 Press .
- 4 Press  or  repeatedly until **Borderless** appears.

5 Press ✓.

6 Press **Start Color** or **Start Black**, or press  to return to the Copy menu to select the number of copies you want.

Select the Borderless photo feature (when printing photos)

1 Press .

2 Press ◀ or ▶ repeatedly until **Layout** appears.

3 Press ✓.

4 Press ◀ or ▶ repeatedly until **Borderless** appears.

5 Press ✓.

6 Press **Start Color** or **Start Black**, or press  to return to the Photo Card menu to select the photos you want to print.

Make sure you use photo paper

Borderless printing requires photo paper. Small margins are printed when you select the Borderless feature when you are printing on plain paper.

Make sure the paper size matches the printer setting

- 1 From the software application, click **File** → **Print**.
- 2 Click **Properties**, **Preferences**, **Options**, or **Setup**.
- 3 Click **Paper Setup**.
- 4 Check the paper size.

Print speed is slow

These are possible solutions. Try one or more of the following:

Maximize computer processing speed

- Close all applications not in use.
- Minimize the number and size of graphics and images in the document.
- Remove as many unused fonts as possible from your system.

Add memory

Consider purchasing more RAM.

Select a lower print quality

- 1 From the software application, click **File** → **Print**.
- 2 Click **Properties**, **Preferences**, **Options**, or **Setup**.
- 3 Click **Quality/Copies**.
- 4 From the Quality/Speed area, select a lower print quality.

Remove and reinstall the software

It is sometimes helpful to remove the existing printer software and reinstall it.

Partial document or photo prints

These are possible causes and solutions. Try one or more of the following:

Check document placement

Make sure the document or photo is loaded facedown on the scanner glass in the lower right corner.

Check paper size

Make sure the paper size being used matches the size you selected.

Photo smudges or scratches

To prevent photo smudging or scratching, avoid touching the printed surface with your fingers or sharp objects. For best results, remove each printed sheet individually from the paper exit tray, and allow the prints to dry at least 24 hours before stacking, displaying, or storing.

Checking the print cartridges

Are the print cartridges properly installed?

For more information, see “Installing print cartridges” on page 130.

Are the sticker and tape removed from the cartridges?

Lift the scanner unit. Press down on the cartridge carrier latches to raise the cartridge carrier lids.

Are the cartridges low on ink?

1 Do one of the following:

- In Windows Vista, click .
- In Windows XP and earlier, click **Start**.

2 Click **Start** → **Programs** or **All Programs** → **Lexmark 6500 Series**.

3 Click **Solution Center**.

4 If an exclamation point (!) appears on a cartridge, the ink level is low. Install a new cartridge. For more information, see “Installing print cartridges” on page 130.

For cartridge-ordering information, see “Ordering paper and other supplies” on page 136.

Ink levels seem incorrect

These are possible solutions. Try one or more of the following:

Are you printing graphics or photos?

When you print documents with a large number of graphics, or with the Photo Quality/Speed setting, the printer uses more ink. The type of documents you print and the print quality you select affect the amount of ink the printer uses.

Are you printing a large file?

The ink levels displayed in the printer software are not updated during a print job; they represent the ink level at the beginning of a print job. The ink levels may seem inconsistent in the Printing Status window when you are printing a large file.

Ink levels seem to go down too quickly

These are possible solutions. Try one or more of the following:

Are you printing photos or documents with a large number of graphics?

Because photos and graphics require more ink than text documents, ink usage increases when you print photos or graphics.

Are you printing with the Best Quality/Speed setting?

To reduce ink usage, select **Best** only when you are printing on photo or heavyweight matte paper. All other paper types print best at a lower Quality/Speed setting. Use the Quick Print or Normal setting to print most text documents.

A blank or incorrect page prints



Remove the sticker and tape from the print cartridges

Lift the scanner unit, and remove the print cartridges from the print cartridge carrier. Make sure the sticker and tape are removed from the print nozzles located on the bottom of the cartridges.

Make sure the cartridges are properly installed

With the front of the printer facing you, check for proper print cartridge installation. If you are using a color cartridge, make sure it is properly installed in the right carrier. If you are using a black or photo cartridge, make sure it is properly installed in the left carrier.

Check the USB connection

- 1 Check that the USB cable is connected to the computer. The USB port on the back of the computer is marked by the  USB symbol. Plug the long, flat end of the USB cable into this port.
- 2 Make sure that the smaller, more square end of the USB cable is plugged into the back of the printer.
- 3 Check that the USB cable is not damaged and that the  light is on.

Close other open files before printing

Before sending a file to print, close all other open files in the program you are using. The printer prints a blank page when too many files are open in the same program.

Characters on printout are missing or unexpected

These are possible solutions. Try one or more of the following:

Make sure the fonts are applied correctly in the program

Most programs do not print a stretched or resized font.

Make sure the TrueType font is available on the computer

The font you are trying to print may not be available in the program font selection box. Not all fonts are designed to be printed; make sure the font is a TrueType font. See the program documentation for more information.

Make sure the document was formatted or created for the printer

Windows may substitute different fonts. Line and page breaks may change with the font. Use the program that created the document to fix these problems, and then save the changes for the next time you print.

Colors on printout are faded or differ from colors on the screen

Check the following. When you think you have solved the problem, test the solution by sending a document to print.

Are the color and print speed settings correct?

You may need to adjust the color and print speed.

Are the print cartridges low on ink?

- 1 Do one of the following:
 - In Windows Vista, click  → **Control Panel**.
 - In Windows XP or 2000, click **Start**.
- 2 Click **Start** → **Programs** or **All Programs** → **Lexmark 6500 Series**.
- 3 Click **Solution Center**.



- 4 If an exclamation point (!) appears on either of the print cartridges, the ink level is low. Install a new cartridge.

Glossy photo paper or transparencies stick together

Do photos or transparencies dry and stick together on the paper exit tray?

Remove the photos or transparencies from the paper exit tray as they exit the printer. Allow them to dry before stacking. It takes longer for the ink to dry on the surface of photo paper or transparencies than it does on most printouts.

Are you using a transparency or photo paper designed for an inkjet printer?

For information on ordering supplies, see “Choosing compatible specialty paper types” on page 71.

Page prints with different fonts

Make sure the correct printer is selected

When printing from an application, make sure the selected printer is the correct printer you want to use to print your job.

It is useful to have the default printer set to be the printer you use most often for printing.

Make sure the TrueType font is available on the computer

The font you are trying to print may not be available in the program font selection box. Not all fonts are designed to be printed; make sure the font is a TrueType font. See the program documentation for more information.

Make sure the fonts are applied correctly in the program

Most programs do not print a stretched or resized font.

Print is too dark or smudged

These are possible solutions. Try one or more of the following:

Make sure the ink dry before handling the paper

Remove the paper as it exits, and let the ink dry before handling.

Make sure the Quality/Speed setting is appropriate for the paper type loaded in the printer

The Photo Quality/Speed setting may cause smearing if used with plain paper. If you are using plain paper, try using the Normal setting.

Make sure the print cartridge nozzles are clean

You may need to clean the print cartridge nozzles.

Printed characters are improperly formed or are not aligned correctly

Have you added spaces at the left margin?

If the print is not aligned correctly, make sure you have not added spaces by pressing Enter or the spacebar (hard-coded spaces).

Do you need to align the print cartridges?

The cartridges may be out of alignment.

- 1 Do one of the following:
 - In Windows Vista, click  → **Control Panel**.
 - In Windows XP or 2000, click **Start**.
- 2 Click **Start** → **Programs** or **All Programs** → **Lexmark 6500 Series**.
- 3 Click **Solution Center**.
- 4 Click the **Maintenance** tab.
- 5 Click **Align to fix blurry edges**.

Are the print cartridges clean?

You may need to clean the print cartridge nozzles.

Printouts have alternating bands of light and dark print

If the printer pauses frequently during a print job and prints pages with alternating bands of light and dark print, it is printing data faster than the computer can send it. Banded printing occurs when the printer pauses frequently. You may need to change the printer software settings, or the problem may be that the printer and the computer are not able to communicate properly.

Are the printer and the computer able to communicate data?

Check the printer status:

- 1 Do one of the following:
 - In Windows Vista, click  → **Control Panel**.
 - In Windows XP or 2000, click **Start**.
- 2 Click **Start** → **Programs** or **All Programs** → **Lexmark 6500 Series**.

3 Click **Solution Center**.

4 If the Printer Status is:

- **Cannot Communicate**, the problem could be hardware or printer software settings.
- **Ready** or **Busy Printing**, the problem may be with the printer software settings.

Transparencies or photos contain white lines

Adjust the Quality/Speed settings

1 With a document or photo open, click **File → Print**.

2 Click **Properties, Preferences, Options, or Setup**.

3 From the Quality/Copies tab, select:

- **Photo** when printing photos
- **Normal** when printing transparencies

Check the program settings

Use a different fill pattern in the program. For more information, see the program documentation.

Perform maintenance on the print cartridges

You may need to clean the print cartridge nozzles.

Vertical straight lines are not smooth

Adjust the Quality/Speed settings

1 With a document or photo open, click **File → Print**.

2 Click **Properties, Preferences, Options, or Setup**.

3 From the Quality/Copies tab, select:

- **Photo** when printing photos
- **Normal** when printing transparencies

Align the print cartridges

1 Do one of the following:

- In Windows Vista, click  → **Control Panel**.
- In Windows XP or 2000, click **Start**.

2 Click **Start → Programs or All Programs → Lexmark 6500 Series**.

3 Click **Solution Center**.

4 Click the **Maintenance** tab.

5 Click **Align to fix blurry edges**.

White lines appear in graphics or solid black areas

Adjust the Quality/Speed settings

- For excellent print quality and reduced print speed, select **Photo**.
- For good print quality and average print speed, select **Normal**.

- For reduced print quality and faster print speed, select **Quick Print**.

Adjust the program settings for the document

Use a different fill pattern in the program. For more information, see the program documentation.

Perform maintenance on the print cartridges

You may need to clean the print cartridge nozzles.

Checking the printer status

Windows Vista users only

- 1 Click  → **Control Panel** → **Printer**.
- 2 Make sure:
 - The printer icon does not say **Paused**. If the printer is paused, right-click the icon, and then click **Resume Printing**.
 - The printer icon says **Ready**. If it says **Offline**, right-click the icon, and then click **Use Printer Online**.
 - The printer icon has a check mark indicating that the printer is set as the default printer. If it is not, right-click the icon, and then click **Set as Default**.

Windows XP users only

- 1 Click **Start** → **Settings** → **Printers and Faxes**.
- 2 Make sure:
 - The printer icon does not say **Paused**. If the printer is paused, right-click the icon, and then click **Resume Printing**.
 - The printer icon says **Ready**. If it says **Offline**, right-click the icon, and then click **Use Printer Online**.
 - The printer icon has a check mark indicating that the printer is set as the default printer. If it is not, right-click the icon, and then click **Set as Default**.

Windows 2000 users only

- 1 Click **Start** → **Settings** → **Printers**.
- 2 Right-click the **Lexmark 6500 Series** icon.
- 3 Make sure:
 - **Set as Default Printer** is selected.
 - **Pause Printing** is *not* selected.
 - **Use Printer Offline** is *not* selected.

Settings are not saved

These are possible solutions. Try one or more of the following:

Change time-out settings

If you press  to select a setting, an * appears next to the selected setting. The printer reverts to the default setting after two minutes of inactivity or if the printer is turned off.

Save settings

If you press  to select a setting, an * appears next to the selected setting.

Checking printer readiness

The printer may not be ready to print. Check the following. When you think you have solved the problem, test the solution by sending a document to print.

Make sure the printer has paper and is properly loaded

Make sure you have followed the correct loading instructions for your printer.

Remove the sticker and tape from the print cartridges



- 1 Lift the scanner unit.
- 2 Remove the print cartridges from the print cartridge carrier.
- 3 Make sure the sticker and tape are removed from the bottom and back of the cartridges.

Do the print cartridges have ink?

- 1 Do one of the following:
 - In Windows Vista, click .
 - In Windows XP and earlier, click **Start**.
- 2 Click **Start** → **Programs** or **All Programs** → **Lexmark 6500 Series**.
- 3 Click **Solution Center**.

If an exclamation point (!) appears on either of the print cartridges, the ink level is low. Install a new cartridge.

Check the USB connection

- 1 Check that the USB cable is connected to the computer. The USB port on the back of the computer is marked by the  USB symbol. Plug the long, flat end of the USB cable into this port.
- 2 Make sure that the smaller, more square end of the USB cable is plugged into the back of the printer.
- 3 Check that the USB cable is not damaged and that the  light is on.

Checking the Spool Settings for banner printing

Banner printing is not possible if certain Spool Settings are selected. Verify that you have the right settings selected.

- 1 Click **Start** → **Settings** → **Printers** or **Printers and Faxes**.
- 2 Right-click the **Lexmark 6500 Series** icon.
- 3 Select **Properties**.
- 4 Click the **Advanced** tab.
- 5 At the bottom of the Advanced tab, click **Print Processor**.
- 6 Verify that the Default data type is LEMF. If it is not, select **LEMF** from the available choices, and then click **OK**.

Resolving font problems

Have you applied the fonts correctly in the program?

Most programs do not print a stretched or resized font.

Is the font a TrueType font? Is it available on the computer?

The font you are trying to print may not be available in the program font selection box. Not all fonts are designed to be printed; make sure the font is a TrueType font. See the program documentation for more information.

Was the document formatted or created for the printer?

Windows may substitute different fonts. Line and page breaks may change with the font. Use the program that created the document to fix these problems, and then save the changes for the next time you print.



Printer is busy printing another job

Wait until the printer has finished printing all other print jobs before sending this job to print.

Ready or Busy Printing is listed as the status

If Ready or Busy Printing is listed as the Printer Status on the Status tab of the Solution Center while you are attempting to print, try the suggestions below. Next, test the solution by sending a document to print.

Is there a problem with the connections?

- 1 Check that the USB cable is connected to the computer. The USB port on the back of the computer is marked by the  USB symbol. Plug the long, flat end of the USB cable into this port.
- 2 Make sure that the smaller, more square end of the USB cable is plugged into the back of the printer.
- 3 Check that the USB cable is not damaged and that the  light is on.

Do you need to adjust the Quality/Speed settings?

Select **Photo** from the Quality/Copies tab in Printing Preferences.

- 1 Click **File → Print**.
- 2 Click **Properties, Preferences, Options, or Setup**.
- 3 From the Quality/Copies tab, make changes as needed.
- 4 Click **OK** to close any dialog boxes that are open.

Is the problem with the program?

Try printing a different image. If it prints correctly, the problem may be with the program you are using. For more information, see the program documentation.

Printing a test page

- 1 Do one of the following:
 - In Windows Vista, click .
 - In Windows XP and earlier, click **Start**.
- 2 Click **Start → Programs** or **All Programs → Lexmark 6500 Series**.
- 3 Click **Solution Center**.
- 4 From the Maintenance tab, click **Print a test page**.

- 5 Compare the printed page to the image displayed on the computer screen. If the printed image matches the image displayed on the screen, then you are finished.
- 6 If the test page did not print at all or has quality problems, attend to any error messages that appear on the screen.

Test page does not print



These are possible solutions. Try one or more of the following:

Make sure the printer is receiving power

If  is not on, the printer may not be receiving power.

- Press .
- Plug the printer into a different electrical outlet.
- If the printer is plugged into a surge protector, unplug the printer, and plug it directly into an electrical outlet.

Check the USB connection

- 1 Check that the USB cable is connected to the computer. The USB port on the back of the computer is marked by the  USB symbol. Plug the long, flat end of the USB cable into this port.
- 2 Make sure that the smaller, more square end of the USB cable is plugged into the back of the printer.
- 3 Check that the USB cable is not damaged and that the  light is on.

Make sure the cartridges are properly installed

With the front of the printer facing you, check for proper print cartridge installation. If you are using a color cartridge, make sure it is properly installed in the right carrier. If you are using a black cartridge or photo cartridge, make sure it is properly installed in the left carrier.

Make sure the sticker and tape are removed from the print cartridges:

- 1 Lift the scanner unit.
- 2 Remove the print cartridges from the print cartridge carrier.
- 3 Make sure the sticker and tape are removed from the bottom and back of the print cartridges.

Try printing a test page again

- 1 Do one of the following:
 - In Windows Vista, click  → **Control Panel**.
 - In Windows XP or 2000, click **Start**.
- 2 Click **Start** → **Programs** or **All Programs** → **Lexmark 6500 Series**.
- 3 Click **Solution Center**.
- 4 Click the **Maintenance** tab.
- 5 Click **Print a test page**.



External print server is not working

If there is an external device connected between the computer and the printer, make sure it supports bidirectional communication.

Disconnect the printer from the external device, and connect it directly to the computer. If the printer works, there may be a problem with the print server. See the documentation that shipped with the print server.

There may be a problem with the USB cable. Try a different cable.

Removing an external print server

- 1 Press  to turn the printer off.
- 2 Make sure the power to the print server is off.
- 3 Remove the USB cable from the external print server.
- 4 Disconnect the external print server from the computer.
- 5 Connect the printer USB cable to the printer.
- 6 Press  to turn the printer back on.

Cable is not connected, is loose, or is damaged

The printer cable must be fully connected and undamaged for proper communication.

Make sure the USB cable is connected to the USB port on the back of the computer

The USB port on the back of the computer is marked by . Plug the long, flat end of the USB cable into this port.

Make sure the other end of the USB cable is connected to the back of the printer

Plug the smaller, more square end of the USB cable into the back of the printer.

Make sure the cable is not damaged or loose

Make sure:

- The USB cable is not damaged.
- The  light is on.

For more information, see the related topic below.

Printer is plugged in but does not print

These are possible solutions. Try one or more of the following:

Make sure the printer is set as the default printer

Try printing a test page.

Make sure the print queue is ready to print

Make sure the printer is set as the default printer and is not being held or paused.

Printer is trying to print to File

If the computer is sending the print jobs to File rather than to the printer connected to the computer, first make sure the printer is attached with a USB cable to a USB port on the computer.

To verify the USB port:

- 1 In Windows Vista, click  → **Control Panel** → **Printers** (under Hardware and Sound).
In Windows XP, click **Start** → **Settings** → **Printers and Faxes**.
- 2 Right-click the **Lexmark 6500 Series** icon.
- 3 From the sidebar menu, select **Properties**.
- 4 Click the **Ports** tab.
- 5 Make sure:
 - The port is set to a USB port.
 - File is not set as the port.

If the document still does not print, then the USB port may not be enabled in the computer. For more information, see the related topic, “Enabling the USB port.”

Printer cannot communicate with computers over peer-to-peer network

These are possible solutions. Try one or more of the following:



Check the status of the host computer and printer

Make sure:

- The host computer is on and is directly connected to the printer.
- The host computer can print to the printer.
- The printer is shown as **Shared** in the Printers and Faxes folder (Windows XP and Windows 2000) or Printers folder (Windows Vista) on the host computer.

Check the printer status

Windows Vista users:

- 1 Click:
 - (default Start menu)  → **Settings** → **Printers**.
 - (Classic Start menu)  → **Control Panel** → **Printers**.
- 2 Right-click the **Lexmark 6500 Series** icon.
- 3 Click **Sharing**.
- 4 Click **Change Sharing Options**, and confirm the Windows prompt.
- 5 Select **Share this printer**, and then give the printer a distinctive name.
- 6 Click **OK**.

Windows XP users:

- 1 Click **Start** → **Settings** → **Printers and Faxes**.
- 2 Right-click the **Lexmark 6500 Series** icon.
- 3 Click **Sharing**.

- 4 Select **Share this printer**, and then give the printer a distinctive name.
- 5 Click **OK**.

Windows 2000 users:

- 1 Click **Start → Settings → Printers**.
- 2 Right-click the **Lexmark 6500 Series** icon.
- 3 Click **Sharing**.
- 4 Select **Shared as**, and then give the printer a distinctive name.
- 5 Click **OK**.

Try to locate the printer from the remote computer

If the printer is shown as Shared on the host computer, but you still cannot print, try to locate the printer from the remote computer.

Windows 2000, Windows XP, or Windows Vista users:

- 1 Open the **Printers** or **Printers and Faxes** folder.
- 2 Right-click the **Lexmark 6500 Series** icon.
- 3 Click **Properties**.
- 4 Click the **Ports** tab, and then click the **Add Port** button.
- 5 Select **Local Port**, and then click the **New Port** button.
- 6 Type the Universal Naming Convention (UNC) Port name, which consists of the server name and the distinctive printer name.
The name should be in the form `\\server\printer`.
- 7 Click **OK**.
- 8 Click **Close**.
- 9 Make sure the new port has been selected on the Ports tab, and then click **Apply**.
The new port is listed with the printer name.
- 10 Click **OK**.

Restart the host computer and the remote computer

Try printing again.

Printer is not able to communicate with the computer

The printer and computer are not able to exchange data. Verify that the printer is plugged in, and the  light is on.

Problems when copying, scanning, or faxing

Close other software

Close all programs not being used.

Change the scanning resolution to a lower value

- 1 Load an original document facedown on the scanner glass.
- 2 From the desktop, double-click the **Productivity Studio** icon.
- 3 From the left pane of the Welcome screen, click **Scan**.
- 4 Click **Custom Settings**.
- 5 Select a lower scan resolution.
- 6 Click **Start**.

Is the original document loaded correctly on the scanner glass?

- Make sure the original document is placed in the upper left corner of the scanner glass.
- Place the item you want to copy facedown on the scanner glass.
- Make sure the upper left corner of the front of the item lines up with the arrows in the corner of the scanner glass.

Wrong printer is attached

The printer attached to the computer is not the correct printer. See the setup documentation for help attaching the printer.

Updating the printer software

The printer software needs to be updated to run properly.



- 1 Start Windows.
- 2 When the desktop appears, insert the software CD for Windows.
The installation screen appears.
- 3 Click **Install**.
- 4 When the Existing Printer Driver Found dialog box appears, select **Update the existing driver software**.

Bidirectional communication is not established

The printer and computer may not be able to exchange data.

These are possible solutions. Try one or more of the following:

Check the USB connection

- 1 Check that the USB cable is connected to the computer. The USB port on the back of the computer is marked by the  USB symbol. Plug the long, flat end of the USB cable into this port.
- 2 Make sure that the smaller, more square end of the USB cable is plugged into the back of the printer.
- 3 Check that the USB cable is not damaged and that the  light is on.

Make sure the printer is receiving power

If the  button is not lit, the printer may not be receiving power.

- Plug the printer into a different outlet.
- If the printer is plugged into a surge protector, unplug the printer, and plug it directly into an electrical outlet.

Make sure the external print server is working

If the printer is connected to an external print server, the problem may be with this print server. Check to make sure the device is working properly and that the printer is connected to the network.

Experiencing poor quality or incorrect output

See the topic that best describes the problem.

- Print is too dark or smudged
- Vertical straight lines are not smooth
- White lines appear in graphics or solid black areas
- Characters are missing or unexpected
- Colors on printout are faded or differ from colors on the screen
- Printouts have alternating bands of light and dark print
- Page prints with different fonts
- Printed characters are improperly formed or are not aligned correctly at the left margin
- Transparencies or photos contain white lines
- Glossy photo paper or transparencies stick together

Cannot print to the network printer

These are possible solutions. Try one or more of the following:

Check print server setup documentation

See the print server documentation for setup instructions if:

- The lights of the print server are not on.
- The installation cable is not connected to the print server.
- The print server is not connected to a power source.

Check USB connection

If you are also using an installation cable:

- 1** Check the installation cable for any obvious damage.
- 2** Firmly plug the rectangular end of the installation cable into the USB port of the computer.
The USB port is marked with the  USB symbol.
- 3** Firmly plug the square end of the installation cable into the USB port on the back of the printer.

Contact network support

Contact your system support person to make sure the printer is connected to a working network connection.

Check power

Make sure the printer is connected to a power source and is turned on. For more information, see “Power button is not lit” on page 138.

Cannot print documents from a flash drive

Check the type of files contained on the flash drive

The printer recognizes:

- Files that have extensions *.DOC, *.XLS, *.PPT, *.PDF, *.RTF, *.DOCX, *.XLSX, *.PPTX, *.WPS, and *.WPD
- Photos

Note: If the flash drive contains only files with extensions *.DOC, *.XLS, *.PPT, *.PDF, *.RTF, *.DOCX, *.XLSX, *.PPTX, *.WPS, or *.WPD, the **File Print** menu appears on the display. If any photos are on the flash drive, the message **Which would you like to print?** appears. Press ◀ or ▶ repeatedly until **Documents** appears.

When **Documents** has appeared, press ✓, and then press ◀ or ▶ to view the files contained on the flash drive.

Check network connections and power

Make sure the printer is connected to your computer through a USB cable, and both the printer and the computer are turned on. Also, make sure the computer contains the applications that support the desired file formats.

Resetting the printer to factory default settings

You can reset your printer to the original settings without using the printer menus.

Note: Resetting to factory default settings will delete all the printer settings you have previously selected.

Make sure the printer is on.

- 1 Press and hold **X** and **Start Color** at the same time, until **Language** appears on the display.
- 2 Press ◀ or ▶ until the language you want appears.
- 3 Press ✓.
- 4 Press ◀ or ▶ until the country or region you want appears.
- 5 Press ✓.

Jams and misfeeds troubleshooting

How to clear and avoid paper jams

To clear the paper path:

- 1 Pull firmly on the paper to remove it. If you cannot reach the paper because it is too far into the printer, lift the scanner unit to open the printer.
- 2 Pull the paper out.
- 3 Close the scanner unit.
- 4 Press ✓.
- 5 Reprint any missing pages.

To avoid paper jams, do not force paper into the printer.

Paper jam in the printer

Eject the paper automatically

To remove the paper jam, eject the paper:

- 1 Press and hold ✓.
- 2 Remove the paper from the paper exit tray.

Remove the paper manually

- 1 Press ⏻ to turn off the printer.
- 2 Firmly grasp the paper, and gently pull it out.
- 3 Press ⏻ to turn the printer back on.

Paper jam in the paper support

- 1 Press ⏻ to turn off the printer.
- 2 Firmly grasp the paper, and gently pull it out.
- 3 Press ⏻ to turn the printer back on.

Paper or specialty media misfeeds

These are possible solutions if paper or specialty media misfeeds or skews, or if multiple sheets feed or stick together. Try one or more of the following:

Check paper condition

Use only new, unwrinkled paper.

Check paper loading

- Load a smaller amount of paper into the printer.
- Load paper with the print side facing you. (If you are not sure which side is the printable side, see the instructions that came with the paper.)

See “Loading paper” on page 60 and its related topics for information about:

- Maximum loading amounts per paper type
- Specific loading instructions for supported paper and specialty media

Remove each page as it is printed

Remove each page as it exits, and let it dry completely before stacking.

Adjust the paper guides

Adjust the paper guides:

- When using media less than 8.5 inches wide
- To rest against the edges of the paper or media, making sure it does not buckle

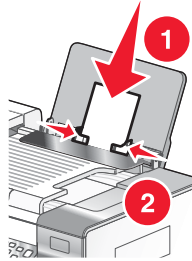

Printer does not feed paper, envelopes, or specialty media

These are possible solutions. Try one or more of the following:

Check for paper jams

Check for and clear any paper jams. For more information, see “Jams and misfeeds troubleshooting” on page 172.

Check media loading

- Verify that the specialty media is loaded correctly. For more information, see “Loading paper” on page 60.
- Try loading one page, envelope, or sheet of specialty media at a time.

Check printer default and pause settings

1 In Windows Vista, click  → **Control Panel** → **Printers** (under Hardware and Sound).

In Windows XP, click **Start** → **Settings** → **Printers and Faxes**.

2 Double-click the print queue device.

3 Click **Printer**.

- Make sure no check mark appears next to **Pause Printing**.
- If a check mark does not appear next to **Set As Default Printer**, you must select the print queue device for each file you want to print.

Banner paper jams

These are possible solutions. Try one or more of the following:

Clear banner paper jams

1 Press  to turn off the printer.

2 Remove the jammed banner paper from the printer.

Review banner printing checklist

- Use only the number of sheets needed for the banner.
- Select the following settings to enable the printer to feed paper continuously without jamming:
 - 1 With a document open, click **File** → **Print**.
 - 2 Click **Properties**, **Preferences**, **Options**, or **Setup**.

- 3 Select the **Paper Setup** tab.
- 4 From the Paper Size area, select **Banner**.
- 5 Select **Letter Banner** or **A4 Banner** as the paper size.
- 6 Select **Portrait** or **Landscape**.
- 7 Click **OK**.
- 8 Click **OK** or **Print**.

Paper continues to jam

Are you using paper designed for an inkjet printer?

Check the type of paper you are using. Some low-quality papers may be too thin or too slick to be fed correctly into the printer. For more information, see “Choosing compatible specialty paper types” on page 71.

Are you loading the paper correctly?

For more information, see “Loading paper” on page 60.

Note: Do not force paper into the printer.

Paper jam in the Automatic Document Feeder (ADF)

- 1 Flip open the ADF by grasping the notch in the left side of the ADF and pulling up.
- 2 Firmly grasp the paper, and gently pull it out.
- 3 Close the ADF.
- 4 Press **√**.

Paper jam in the duplex unit

- 1 Push down on the duplex latch as you grasp the duplex unit.

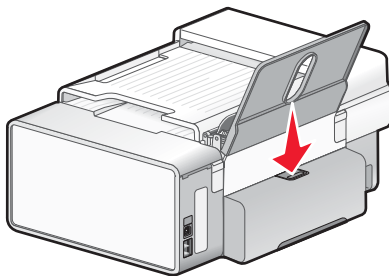

- 2 Pull out the duplex unit.

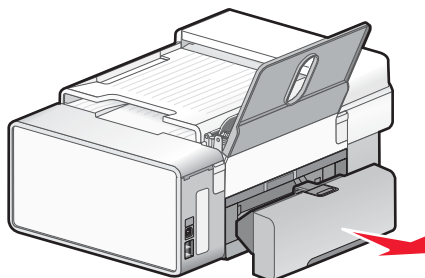

3 Firmly grasp the paper, and gently pull it out.

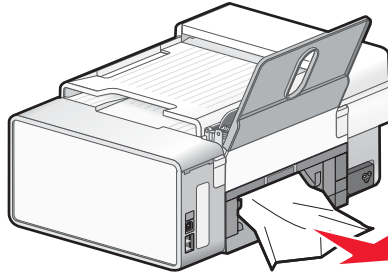

4 Push down on the duplex latch as you reinstall the duplex unit.

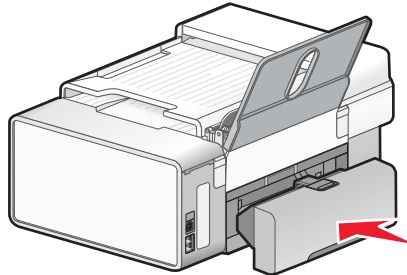

5 Press \checkmark .

6 On your computer, delete or stop the print job, and then try resending the print job again.

Duplex unit does not operate correctly

These are possible solutions. Try one or more of the following:

Check paper size and type

Check the paper size and type to make sure the paper is supported by the printer. If you are using automatic duplexing, use only letter- or A4-size plain paper.

Check for paper jams

Check for and clear any paper jams. For more information, see “Paper jam in the duplex unit” on page 175.

Make sure the duplex unit is properly installed

Remove the duplex unit and reinstall it. For more information, see “Paper jam in the duplex unit” on page 175.

Memory card troubleshooting

Memory card cannot be inserted

These are possible solutions. Try one or more of the following:

Check memory card type

Make sure that the type of memory card you are using can be used in the printer.

Check memory card placement

Make sure you have inserted the memory card in the correct slot.

Nothing happens when memory card is inserted

These are possible solutions. Try one or more of the following:

Reinsert the memory card

The memory card may have been inserted too slowly. Remove and then reinsert the memory card quickly.

Check memory card placement

Make sure you have inserted the memory card in the correct slot. For more information, see “Inserting a memory card” on page 78.

Check memory card type

Make sure that the type of memory card you are using can be used in the printer. For more information, see “Inserting a memory card” on page 78.

Check to see if the memory card is damaged

Check that there is no obvious damage to the memory card.

Check to see if the memory card contains photos

Insert a memory card that contains photos.

Make sure the USB cable is connected

If the printer is connected to the computer through a USB cable:

- 1 Check the USB cable for any obvious damage.
- 2 Firmly plug the square end of the USB cable into the back of the printer.
- 3 Firmly plug the rectangular end of the USB cable into the USB port of the computer.

The USB port is marked with the  USB symbol.

Check the network connection

If the printer and computer are connected over a network, make sure that the correct host and device are communicating. Select the printer from the computer or the computer from the printer.

Photos do not transfer from a memory card across a wireless network

These are possible solutions. Try one or more of the following:

Select the printer on your wireless network

Windows users only

If you have more than one printer and use Windows, you must select your wireless network printer.

- 1 Do one of the following:
 - In Windows Vista, click  → **Control Panel** → **Printers**.
 - In Windows XP and earlier, click **Start** → **Settings** → **Printers and Faxes**.
- 2 From the list shown, select the printer on your wireless network.

Note: To select the printer, right click the printer, and then select **Set as Default Printer**.
- 3 Insert the memory card in the printer.

- 4 From the control panel, press ✓.
- 5 Press ▼ to choose **Select Computer**.
- 6 Press ✓.
- 7 From the list shown, select the computer on your wireless network.
- 8 Follow the prompts on the computer screen. For more information, see the “Working with photos” chapter in the *User's Guide: Comprehensive Version*.

Check memory card placement

Make sure you inserted the memory card into the correct slot.

Check memory card type

Make sure that the type of memory card you are using can be used in the printer.

Check to see if the memory card is damaged

Check to see that there is no obvious damage to the memory card. Remove memory cards properly from the printer to avoid corruption of data.

Check to see if the memory card contains photos

Insert a memory card that contains photos. The printer reads photos that are in the JPEG format. For more information, see the documentation that came with your camera.

Check to see if your printer or the computer is turned on

Make sure that your printer and your computer are turned on. Make sure that Windows is open.

Check to see if your wireless connection is active

Make sure that your wireless network is connected and active.

Note: If your wireless connection is down, use your configuration cable to connect your printer to your computer.

Copy troubleshooting

Copier does not respond

These are possible solutions. Try one or more of the following:

Check messages

Resolve all error messages.

Check power

If the Ⓟ light is not on, make sure the printer is plugged into a properly grounded outlet. Make sure the power cord is properly connected to the printer.

Scanner unit does not close

- 1 Lift the scanner unit.
- 2 Remove any obstruction keeping the scanner unit open.

3 Lower the scanner unit.

Poor copy quality

- Blank pages
- Checkerboard pattern
- Distorted graphics or pictures
- Missing characters
- Faded print
- Dark print
- Skewed lines
- Smudges
- Streaks
- Unexpected characters
- White lines in print

These are possible solutions. Try one or more of the following:

Check messages

If an error message is displayed, see “Error messages on the computer screen” on page 197.

Check ink

Check the ink levels, and install a new print cartridge if necessary.

Clean the scanner glass

If the scanner glass is dirty, gently wipe it with a clean, lint-free cloth dampened with water.

Review steps to improve print quality

See “Improving print quality” on page 154.

Adjust the brightness of the copy

- 1 Load the document facedown on the scanner glass.
- 2 From the control panel, press **Copy Mode**.
- 3 Press **Lighter/Darker**.
- 4 Press ◀ or ▶ repeatedly to lighten or darken the copy.
- 5 Press **Start Color** or **Start Black**.

Check quality of original document

If the quality of the original document is not satisfactory, try using a clearer version of the document or image.

Are you scanning from photo or glossy paper, a magazine, or a newspaper?

If you are copying or scanning from photo or glossy paper, a magazine, or a newspaper, see “Scanning clear images from magazines or newspapers” on page 110.

Check document placement

Make sure the document or photo is loaded facedown on the scanner glass in the lower right corner.

Partial document or photo copies

These are possible solutions. Try one or more of the following:

Check document placement

Make sure the document or photo is loaded facedown on the scanner glass in the lower right corner.

Check paper size

Make sure the paper size being used matches the size you selected.

Check Original Size setting

Make sure that the Original Size setting is **Automatic** or the size of the original document that you are copying.

Copied item does not match the original item

Is the original document loaded correctly on the scanner glass?

- Make sure the original document is placed in the lower right corner of the scanner glass.
- Place the item you want to copy facedown on the scanner glass.
- Make sure the upper left corner of the *front* of the item lines up with the arrows in the lower right corner of the scanner glass.

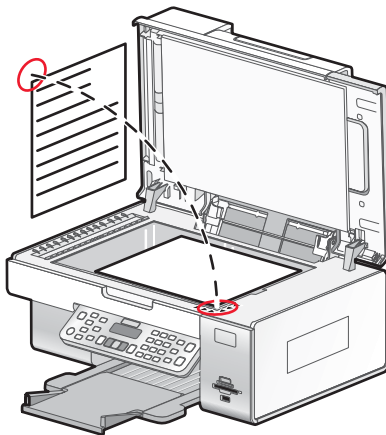

Scan troubleshooting

Scanner does not respond

These are possible solutions. Try one or more of the following:

Check messages

Resolve all error messages.

Check power

If the  light is not on, make sure the printer is plugged into a properly grounded outlet. Make sure the power cord is properly connected to the printer.

Check printer default and pause settings

- 1 Do one of the following:
 - In Windows Vista, click  → **Control Panel**.
 - In Windows XP, click **Start**.
- 2 Click **Printer** or **Printers and Faxes**.
- 3 Double-click the printer you want to check.
- 4 Click **Printer**.
- 5 Make sure no check mark appears next to Pause Printing. If a check mark appears next to Set As Default Printer, you must select the correct printer from a list each time you print.

Removing and reinstalling the software

For more information, see “Removing and reinstalling the software” on page 141.

Scan was not successful

These are possible solutions. Try one or more of the following:

Check USB cable connection

- 1 Check the USB cable for any obvious damage.
- 2 Firmly plug the square end of the USB cable into the back of the printer.
- 3 Firmly plug the rectangular end of the USB cable into the USB port of the computer.

The USB port is marked with the  USB symbol.

Restart computer

Turn off and then restart your computer.

Scanning takes too long or freezes the computer

These are possible solutions. Try one or more of the following:

Close other software

Close all programs not being used.

Change the scanning resolution to a lower value

- 1 Load an original document facedown on the scanner glass.
- 2 From the desktop, double-click the **Productivity Studio** icon.
- 3 From the Welcome Screen, click **Scan**.
- 4 Click **Custom Settings**.
- 5 From the Scan Resolution drop-down list, select a lower scan resolution.
- 6 Click **Start**.

Poor scanned image quality

These are possible solutions. Try one or more of the following:

Check messages

If an error message is displayed, see “Error messages on the printer display” on page 191.

Clean the scanner glass

If the scanner glass is dirty, gently wipe it with a clean, lint-free cloth dampened with water.

Adjust the quality of the scan

- 1 Load an original document facedown on the scanner glass.
- 2 From the desktop, double-click the **Productivity Studio** icon.
- 3 From the left pane of the Welcome screen, click **Scan**.
- 4 Click **Custom Settings**.
- 5 Select a higher scan resolution.
- 6 Click **Start**.

Review steps to improve print quality

See “Improving print quality” on page 154.

Are you scanning from photo or glossy paper, a magazine, or a newspaper?

If you are copying or scanning from photo or glossy paper, a magazine, or a newspaper, see “Removing wavy patterns from scanned photos, magazines, or newspapers” on page 90.

Check quality of original document

If the quality of the original document is not satisfactory, try using a clearer version of the document or image.

Check document placement

Make sure the document or photo is loaded facedown on the scanner glass in the upper left corner.

Partial document or photo scans

These are possible solutions. Try one or more of the following:

Check document placement

Make sure the document or photo is loaded facedown on the scanner glass in the lower right corner.

Check paper size

Make sure the paper size being used matches the size you selected.

Check Original Size setting

Make sure the Original Size setting is **Automatic** or the size of the original document you are scanning.

Cannot scan to a computer over a network

See “Scanning to a computer over a network” on page 109.

Fax troubleshooting

Cannot send or receive a fax

These are possible solutions. Try one of the following:

Check messages

If an error message is displayed, follow the instructions on the display.

Check power

If the  light is not on, see “Power button is not lit” on page 138.

Check cable connections

Make sure cable connections for the following hardware are secure, if applicable:

- Power supply
- Telephone
- Handset
- Answering machine

Check the telephone wall jack

- 1 Plug a telephone into the wall jack.
- 2 Listen for a dial tone.
- 3 If you do not hear a dial tone, plug a different telephone into the wall jack.
- 4 If you still do not hear a dial tone, plug a telephone into a different wall jack.
- 5 If you hear a dial tone, connect the printer to that wall jack.

Review digital phone service checklist

The fax modem is an analog device. Certain devices can be connected to the printer so that digital telephone services can be used.

- If you are using an ISDN telephone service, connect the printer to an analog telephone port (an R-interface port) on an ISDN terminal adapter. For more information and to request an R-interface port, contact your ISDN provider.
- If you are using DSL, connect to a DSL filter or router that supports analog use. For more information, contact your DSL provider.
- If you are using a PBX telephone service, make sure you are connecting to an analog connection on the PBX. If none exists, consider installing an analog telephone line for the fax machine. For more information on faxing when using a PBX telephone service, see “Setting up to fax while behind a PBX” on page 36.

Verify dial tone

- Place a test call to the telephone number to which you want to send a fax to make sure that it is working correctly.
- If the telephone line is being used by another device, wait until the other device is finished before sending a fax.
- If you are using the On Hook Dial feature, turn up the volume to verify a dial tone.

Disconnect other equipment temporarily

To ensure the printer is working correctly, connect it directly to the telephone line. Disconnect any answering machines, computers with modems, or telephone line splitters.

Check for paper jams

Check for and clear any paper jams.

Disable Call Waiting temporarily

Call Waiting can disrupt fax transmissions. Disable this feature before sending or receiving a fax. Contact your telephone company to obtain the keypad sequence for temporarily disabling Call Waiting.

Do you have Voice Mail service?

Voice Mail offered through your local telephone company may disrupt fax transmissions. To enable both Voice Mail and the printer to answer calls:

- See “Setting the distinctive ring” on page 127. Setting selections include single ring, double ring, triple ring, and any ring.
- Consider adding a second telephone line for the printer.

Check country code

Make sure the country code has been set for the country or region where you are operating the printer:

- 1 From the control panel, press **Settings**.
- 2 Press ◀ or ▶ repeatedly until **Device Setup** appears.
- 3 Press ✓.
- 4 Press ◀ or ▶ repeatedly until **Country** appears.
- 5 Press ✓.
- 6 Press ◀ or ▶ repeatedly until the country or region setting indicated by an * appears.
- 7 If you want to change the country code:
 - a Press ◀ or ▶ repeatedly until the country or region where you are operating the printer appears.
 - b Press ✓ to save the setting.

Is your printer memory full?

Change setting to Scan after Dial.

- 1 From the control panel, press **Fax Mode**.
- 2 Press .
- 3 Press ◀ or ▶ repeatedly until **Fax Setup** appears.
- 4 Press ✓.
- 5 Press ◀ or ▶ repeatedly until **Dialing and Sending** appears.
- 6 Press ✓.

- 7 Press ◀ or ▶ repeatedly until **Scan** appears.
- 8 Press ✓.
- 9 Press ◀ or ▶ repeatedly until **After Dial** appears.
- 10 Press ✓.

Can send but not receive faxes

These are possible causes and solutions. Try one or more of the following:

Load paper

Load paper to print any faxes that have been stored in the printer.

Check the Auto Answer button

If the Auto Answer light is on:

- The printer will answer after the preset number of telephone rings.
- If you are using a distinctive ring, see “Setting the distinctive ring” on page 127.

Check ink

Check the ink levels, and install a new cartridge if necessary.

Check whether Fax Forwarding is selected

- 1 From the control panel, press **Fax Mode**.
- 2 Press .
- 3 Press ◀ or ▶ repeatedly until **Fax Setup** appears.
- 4 Press ✓.
- 5 Press ◀ or ▶ repeatedly until **Ringing and Answering** appears.
- 6 Press ✓.
- 7 Press ◀ or ▶ repeatedly until **Fax Forward** appears.
- 8 Press ✓.
- 9 Press ◀ or ▶ repeatedly to view the current Fax Forwarding setting.
- 10 To turn off Fax Forwarding, press ◀ or ▶ repeatedly until **off** appears.
- 11 Press ✓ to save the setting.

Can receive but not send faxes

These are possible causes and solutions. Try one or more of the following:

Check mode selection

To make sure the printer is set for faxing, press **Fax Mode**.

Check document placement

Load the original document facedown in the ADF.

Check the Dial Prefix setting

- 1 From the control panel, press **Fax Mode**.
- 2 Press .
- 3 Press ◀ or ▶ repeatedly until **Fax Setup** appears.
- 4 Press ✓.
- 5 Press ◀ or ▶ repeatedly until **Dialing and Sending** appears.
- 6 Press ✓.
- 7 Press ◀ or ▶ repeatedly until **Dial Prefix** appears.
- 8 Press ✓.
- 9 To change the setting, press ◀ or ▶ repeatedly until **Create** appears.
- 10 Press ✓.
- 11 Enter the prefix to be dialed before each telephone number.
- 12 Press ✓.

Check Speed Dial number

- Check to make sure Speed Dial has been programmed for the number that you want to dial. See “Setting up Speed Dial” on page 128.
- As an alternative, dial the telephone number manually.

Be sure the printer is detecting a dial tone

- See “Sending a fax while listening to a call (On Hook Dial)” on page 115.
- Check the Dial Method setting.
 - 1 Listen for a dial tone. If you hear a dial tone but the printer hangs up without dialing, this means it did not recognize the dial tone.
 - 2 From the control panel, press **Fax Mode**.
 - 3 Press .
 - 4 Press ◀ or ▶ repeatedly until **Fax Setup** appears.
 - 5 Press ✓.
 - 6 Press ◀ or ▶ repeatedly until **Dialing and Sending** appears.
 - 7 Press ✓.
 - 8 Press ◀ or ▶ repeatedly until **Dial Method** appears.
 - 9 Press ✓.
 - 10 Press ◀ or ▶ repeatedly until **Behind PBX** appears.
 - 11 Press ✓ to save this setting.

Printer receives a blank fax

These are possible causes and solutions. Try one or more of the following:

Check original document

Ask the sender to verify the original document was loaded correctly.

Check ink

Check the ink levels, and install a new print cartridge if necessary.

Check cartridges

- 1 Remove the print cartridges.
- 2 Make sure the sticker and tape have been removed.

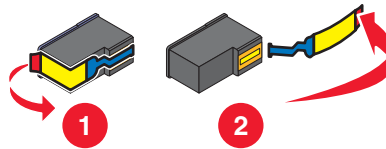

- 3 Reinsert the print cartridges.

Received fax has poor print quality

These are possible causes and solutions. Try one or more of the following:

Review checklist for sender

- Check that the quality of the original document is satisfactory.
- Resend the fax. There may have been a problem with the quality of the telephone line connection.
- Increase the fax scan resolution.

Check ink

Check the ink levels, and install a new print cartridge if necessary.

Clean scan lens and white roller

- 1 Unplug the power cord and the phone line from the wall.
- 2 Open the control panel.
- 3 Push the roller lever gently to the left, pull it forward, and then lift the white roller out of the printer.
- 4 Use a clean, lint-free cloth dampened with water to wipe the white roller and the scan lens.

Note: The scan lens is located under the white roller.

- 5 Reinstall the dry white roller, push the roller lever gently to the left, and then *snap* it in to place.
- 6 Reconnect the power cord and the phone line.

Caller ID information is not displayed

Caller ID pattern may not be set correctly

The printer supports two distinct Caller ID patterns: Pattern 1 (FSK) and Pattern 2 (DTMF). Depending on the country or region you live in and the telecommunications company you subscribe to, you may need to switch the pattern for the printer to display Caller ID information. For more information, see “Using Caller ID from the control panel” on page 116.

Changing Caller ID pattern using the control panel

The printer supports two distinct Caller ID patterns: Pattern 1 (FSK) and Pattern 2 (DTMF). Depending on the country or region you live in and the telecommunications company you subscribe to, you may need to switch the pattern for the printer to display Caller ID information.

- 1 From the control panel, press **Settings**.
- 2 Press ◀ or ▶ repeatedly until **Device Setup** appears.
- 3 Press ✓.
- 4 Press ◀ or ▶ repeatedly until **Caller ID Pattern** appears.
- 5 Press ✓.
- 6 Press ◀ or ▶ repeatedly until the Caller ID pattern setting indicated by an * appears.

Note: The number of patterns is defined by the country or region setting and only the number of patterns defined for the selected country or region is shown.

- 7 If you want to change the Caller ID pattern:
 - a Press ◀ or ▶ repeatedly until the Caller ID pattern you want appears.
 - b Press ✓ to save the setting.

Fax Error

The fax machines have stopped communicating.

Resend the fax. There may have been a problem with the quality of the telephone line connection.

Fax Mode Unsupported

The receiving fax machine does not support the type of fax you attempted to send. If it does not support:

- Your scan resolution—lower the scan resolution.
 - 1 From the control panel, press **Fax Mode**.
 - 2 Press .
 - 3 Press ◀ or ▶ repeatedly until **Quality** appears.
 - 4 Press ✓.
 - 5 Press ◀ or ▶ repeatedly until a lower quality appears.
 - 6 Press ✓.
- Legal-size paper—reformat the document on letter-size paper.













Remote Fax Error

These are possible causes and solutions. Try one or more of the following:

Check phone line

Resend the fax. There may have been a problem with the quality of the telephone line connection.

Lower the transmission speed

- 1 From the control panel, press **Fax Mode**.
- 2 Press .
- 3 Press  or  repeatedly until **Fax Setup** appears.
- 4 Press .
- 5 Press  or  repeatedly until **Dialing and Sending** appears.
- 6 Press .
- 7 Press  or  repeatedly until **Max Send Speed** appears.
- 8 Press .
- 9 Press  or  repeatedly until a lower speed appears.
- 10 Press .

Notes:

- The lower the transmission speed, the longer it will take your fax to send.
- This solution will reduce the speed for future faxes until you reset the transmission speed.

- 11 Resend the fax.
- 12 If the problem persists, repeat the previous steps to send the fax at successively lower transmission speeds.

Note: 2400 bps is the lowest transmission speed.







Phone Line Busy

These are possible causes and solutions. Try one or more of the following:

Change redial settings

The printer automatically redials three times at 2-minute intervals. You can change the default settings to redial up to five times at intervals up to 8 minutes.

To change the redial settings:

- 1 From the control panel, press **Fax Mode**.
- 2 Press .
- 3 Press  or  repeatedly until **Fax Setup** appears.
- 4 Press .
- 5 Press  or  repeatedly until **Dialing and Sending** appears.

- 6 Press ✓.
- 7 To change the number of times the printer will redial:
 - a Press ◀ or ▶ repeatedly until **Redial Attempts** appears.
 - b Press ✓.
 - c Press ◀ or ▶ repeatedly until the setting you want appears.
 - d Press ✓.
- 8 To change the length of time between redials:
 - a Press ◀ or ▶ repeatedly until **Redial Time** appears.
 - b Press ✓.
 - c Press ◀ or ▶ repeatedly until the setting you want appears.
 - d Press ✓.

Schedule to resend fax at a later time

See “Sending a broadcast fax at a scheduled time” on page 115.

Failed to Connect

These are possible causes and solutions. Try one or more of the following:

Use phone line checklist

- Resend the fax. There may have been a problem with the quality of the telephone line connection.
- Place a test call to the telephone number to which you want to send a fax to make sure that it is working correctly.
- If the telephone line is being used by another device, wait until the other device is finished before sending the fax.

Make sure the printer detects dial tone

- See “Sending a fax while listening to a call (On Hook Dial)” on page 115.
- Check the Dial Method setting.
 - 1 Listen for a dial tone. If you hear a dial tone, but the printer hangs up without dialing, this means it did not recognize the dial tone.
 - 2 From the control panel, press **Fax Mode**.
 - 3 Press .
 - 4 Press ◀ or ▶ repeatedly until **Fax Setup** appears.
 - 5 Press ✓.
 - 6 Press ◀ or ▶ repeatedly until **Dialing and Sending** appears.
 - 7 Press ✓.
 - 8 Press ◀ or ▶ repeatedly until **Dial Method** appears.
 - 9 Press ✓.
 - 10 Press ◀ or ▶ repeatedly until the method you want appears.
 - 11 Press ✓ to save this setting.

Phone Line Error

These are possible causes and solutions. Try one or more of the following:

Review digital phone service checklist

The fax modem is an analog device. Certain devices can be connected to the printer so that digital telephone services can be used.

- If you are using an ISDN telephone service, connect the printer to an analog telephone port (an R-interface port) on an ISDN terminal adapter. For more information and to request an R-interface port, contact your ISDN provider.
- If you are using DSL, connect to a DSL filter or router that will support analog use. For more information, contact your DSL provider.
- If you are using a PBX telephone service, make sure you are connecting to an analog connection on the PBX. If none exists, consider installing an analog telephone line for the fax machine. For more information on faxing when using a PBX telephone service, see “Setting up to fax while behind a PBX” on page 36.

Check phone line

If the telephone line is being used by another device, wait until the other device is finished before sending the fax.

Check cable connections

Make sure cable connections for the following hardware are secure, if applicable:

- Power supply
- Telephone
- Handset
- Answering machine

Error messages on the printer display

Alignment Error

These are possible solutions. Try one or more of the following:

Remove tape from print cartridge

- 1 Remove the print cartridge.
- 2 Make sure the sticker and tape have been removed.

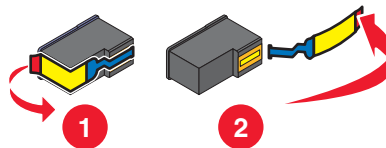

- 3 Reinsert the cartridge.
- 4 Press  to align the cartridge.



For more information, see “Aligning print cartridges” on page 133.

Use new paper

Load only plain, unmarked paper for aligning the cartridge.



The printer will read any markings on used paper, which could cause the alignment error message to appear.

Cartridge Error (1102, 1203, 1204, or 120F)

- 1 Remove the print cartridges, and close the cartridge carrier lids.
- 2 Close the scanner unit.
- 3 Disconnect the power cord from the electrical outlet.
- 4 Reconnect the power cord to the electrical outlet.
- 5 If the  button is not lit, press .
- 6 Reinsert the print cartridges and close the cartridge carrier lids.
- 7 Close the scanner unit.

If the error does not reappear, the problem has been corrected.

If the problem reappears, one of the cartridges is not working properly. Continue with the following procedure to determine which cartridge is not working properly.

- 1 Remove the print cartridges, and close the cartridge carrier lids.
- 2 Close the scanner unit.
- 3 Disconnect the power cord from the electrical outlet.
- 4 Reconnect the power cord to the electrical outlet.
- 5 If the  button is not lit, press .
- 6 Reinsert the black (or photo) print cartridge and close the cartridge carrier lid.
- 7 Close the scanner unit.
- 8 If the error:
 - Reappears, replace the black (or photo) print cartridge with a new one, close the cartridge carrier lid, and close the scanner unit.
 - Does not reappear, reinsert the color print cartridge, close the cartridge carrier lid, and close the scanner unit.
- 9 If the error reappears, replace the color print cartridge with a new one, close the cartridge carrier lid, and close the scanner unit.

Black Ink Low / Color Ink Low / Photo Ink Low

- 1 Check the indicated ink level or levels, and install a new print cartridge or cartridges if necessary.
To order supplies, see "Ordering paper and other supplies" on page 136.
- 2 Press  to continue.

Clear Carrier Jam

Remove any obstructions

- 1 Raise the scanner unit.
- 2 Remove any objects blocking the path of the print cartridge carrier.

- 3 Make sure the cartridge carrier lids are closed.

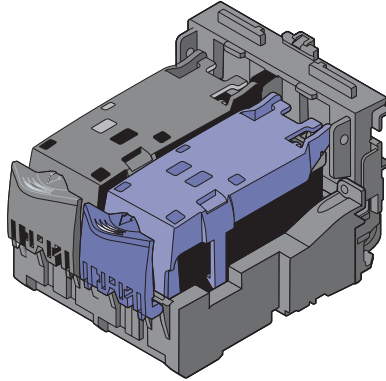

- 4 Close the scanner unit.

- 5 Press ✓.

Cover Open

Make sure that the scanner unit is closed.

Error 1104

- 1 Remove the print cartridges.
- 2 Reinstall the black cartridge or the photo cartridge in the left carrier.
- 3 Reinstall the color cartridge in the right carrier.



Left Cartridge Error / Right Cartridge Error

This message may also appear as Error 1205 (Left Cartridge) or Error 1206 (Right Cartridge).

- 1 Remove the indicated print cartridge and close the cartridge carrier lid.
- 2 Close the scanner unit.
- 3 Disconnect the power cord from the electrical outlet.
- 4 Reconnect the power cord to the electrical outlet.
- 5 If the ⏻ button is not lit, press ⏻.
- 6 Reinsert the print cartridge and close the cartridge carrier lid.
- 7 Close the scanner unit.
- 8 If the error:
 - Does not reappear, the problem has been corrected.
 - Reappears, replace the print cartridge with a new one, close the cartridge carrier lid, and close the scanner unit.

Left Cartridge Incorrect / Right Cartridge Incorrect

- 1 Remove the indicated print cartridge and close the cartridge carrier lid.
- 2 Close the scanner unit.
- 3 Disconnect the power cord from the electrical outlet.

- 4 Reconnect the power cord to the electrical outlet.
- 5 If the  button is not lit, press .
- 6 Reinsert the print cartridge and close the cartridge carrier lid.
- 7 Close the scanner unit.
- 8 If the error:
 - Does not reappear, the problem has been corrected.
 - Reappears, replace the print cartridge with a new one, close the cartridge carrier lid, and close the scanner unit.

Left Cartridge Missing / Right Cartridge Missing

One or both print cartridges are missing or not installed properly. For more information, see “Installing print cartridges” on page 130.

Notes:

- You can make a color copy with only the color cartridge installed.
- You can print a black-and-white document with only the black cartridge installed.
- You cannot copy or print when only the photo cartridge is installed.
- To remove the error message, press .

Memory Failure

These are possible solutions. Try one or more of the following:

Reduce memory use

If applicable:

- Print pending received faxes.
- Send fewer pages.

Select the After Dial setting

- 1 From the desktop, double-click the **Productivity Studio** icon.
- 2 From the Welcome Screen, click **Fax History and Settings**.
- 3 Click **Adjust speed dial list and other fax settings**.
- 4 Click the **Dialing and Sending** tab.
- 5 From the “Sending options” area, select **After Dial** from the “When to scan document” section.
- 6 Click **OK**.
- 7 Resend the fax.

No images have been selected

You have not selected any of the options on step 1 of the photo proof sheet you printed and scanned.

- 1 Make sure you completely fill in your selected circle or circles.
- 2 Press  to continue.

No photo/paper size selection has been made

You have not selected any of the options on step 2 of the photo proof sheet you printed and scanned.

- 1 Make sure you completely fill in your selected circle or circles.
- 2 Press **X** to continue.

Could not detect a proof sheet

The document placed on the scanner glass is not a valid proof sheet. For more information, see “Printing photos stored on the memory device using the proof sheet” on page 93.

No proof sheet information

The photo proof sheet you printed and scanned is no longer valid.

You may have removed the memory card or flash drive from the printer, or turned off the printer, before scanning the photo proof sheet.

For more information, see “Printing photos stored on the memory device using the proof sheet” on page 93.

No valid photo image files detected

No supported images have been found on the memory card or flash drive.

The printer will read photos created using the JPEG format. For more information, see the documentation that came with the digital camera.

Only one photo enhancement may be chosen at a time

You have selected more than one option on step 2 of the photo proof sheet you printed and scanned.

- 1 Make sure you completely fill in only one circle for each option.
- 2 Press **X** to continue.

Only one photo/size selection can be chosen at a time

You have selected more than one option on step 2 of the photo proof sheet you printed and scanned.

- 1 Make sure you completely fill in only one circle for each option.
- 2 Press **X** to continue.

Paper/Photo Size Error

There are one or more photos larger than the paper size you selected on the printer menu.

- 1 Press **X** to clear the error message.
- 2 Press **◀** or **▶** repeatedly until **Paper Setup** appears on the display.
- 3 Press **✓**.
- 4 Press **◀** or **▶** repeatedly until **Paper Size** appears.
- 5 Press **✓**.
- 6 Press **◀** or **▶** repeatedly to select the paper size option that will fit your largest photo size.
- 7 Press **Start Color** or **Start Black** to begin printing.

PictBridge communications error

Remove and then reinsert the USB cable that came with the camera into the PictBridge port on the front of the printer.

Please remove the camera card.

The printer can read either a PictBridge-enabled digital camera or a memory card, but not both at the same time.

- 1 Remove both the PictBridge-enabled digital camera and the memory card.
- 2 Reinsert only one of the devices mentioned above.

Some photos removed from card by host.

Some of the photos on the photo proof sheet were deleted from the memory card through the computer.

You must print a new photo proof sheet.

For more information, see “Printing photos stored on the memory device using the proof sheet” on page 93.













Problems reading the memory card

- See “Memory card cannot be inserted” on page 176.
- See “Nothing happens when memory card is inserted” on page 177.

2-Sided Paper Type Error

The paper type loaded in the printer is *not* plain paper.

To print or copy on both sides of the paper, use only plain paper.

- 1 Press  to clear the error message.
- 2 Load plain paper.
- 3 Press **Settings**.
- 4 Press  or  until **Paper Setup** appears on the display.
- 5 Press .
- 6 Press  or  until **Paper Type** appears.
- 7 Press .
- 8 Press  or  until **Auto Detect** or **Plain** appears.
- 9 Press .
- 10 If  is not lit, press .
- 11 Press **Start Color** or **Start Black**.

File Not Supported

The computer failed to find an application to support the file that you want to print.

Make sure that the memory card or flash drive inserted into the printer contains files that have file name extensions DOC, XLS, PPT, PDF, RTF, DOCX, XLSX, PPTX, WPS, or WPD.

For more information, see “Printing document files from a memory card or flash drive” on page 69.

Unsupported Paper Size

The paper size you selected from the PictBridge-enabled digital camera is not supported by the printer.

- 1 From the control panel, press **X** to clear the error message.
- 2 Press .
- 3 Press **◀** or **▶** until **Paper Setup** appears.
- 4 Press **✓**.
- 5 Press **◀** or **▶** repeatedly until **Paper Size** appears.
- 6 Press **✓**.
- 7 Press **◀** or **▶** repeatedly until the size you want appears.
- 8 Press **✓**.
- 9 Press **Start Color** or **Start Black** to begin printing.

Error messages on the computer screen

Clearing error messages

- 1 Correct the error condition explained in the error message. Click **Help** on the error message dialog box for specific instructions.
- 2 After correcting the error condition, click **Continue** to resume printing.

If the error remains, but you want to clear the error message:

- 1 Click **Cancel Printing**. The error message closes, and the Canceling Printing dialog box appears.
- 2 Follow the instructions on the Canceling Printing dialog box.

Left/Right Cartridge Missing



This message indicates that one of the necessary cartridges is missing. You need to install a print cartridge.

Communication not available

The printer and computer may not be able to exchange data.

Is the printer receiving power?

If  is not lit, the printer may not be receiving power.

- Plug the printer into a different outlet.
- If the printer is plugged into a surge protector, unplug the printer, and plug it directly into an electrical outlet.

Is there a problem with the connections?

If the printer is connected to an external device, the problem may be with the device. Check the setup information that came with the device to make sure it is properly installed.

If printing using a USB cable, make sure the cable is securely attached to both the printer and the computer.

Before you print, you may need to restart the computer.

General Printing Problem

You cannot receive a more specific error message because the printer and the computer do not have bidirectional communication.

To receive a more specific error message, see “Bidirectional communication is not established” on page 170.

To find the problem without establishing bidirectional communication, see “Checking printer readiness” on page 164.

Ink Low

A print cartridge is almost out of ink.



Install a new cartridge. For more information, see “Installing print cartridges” on page 130.

To order a new cartridge, see “Ordering paper and other supplies” on page 136.

Out of Memory

The printer software cannot obtain enough memory to print.

Try the following:

- Before sending a document to print, close any other open programs. The printer may print a blank page when too many programs are open on the computer.
- Follow the instructions on the error screen. These instructions reduce the amount of memory needed to print.

Out of Paper

1 Load paper.

2 Press ✓ to continue printing.

Note: Do not force paper into the printer.

Fixing a printing failure

Follow the instructions on the computer screen.

If the printer still does not print:

1 Do one of the following:

- In Windows Vista, click .
- In Windows XP and earlier, click **Start**.

2 Click **Start** → **Programs** or **All Programs** → **Lexmark 6500 Series**.

3 Click **Solution Center**, and then click the **Contact Information** tab.

Unsupported file types found on memory card

The memory card inserted in the printer contains unsupported file types. Insert a memory card with supported file types. For more information on supported file types, see the *User's Guide* on the CD that came with your printer.

Paper Jam

The printer has a paper jam, and you must clear the paper path.

Note: To avoid paper jams, do not force paper into the printer.

Multiple All-In-Ones found

Multiple Lexmark printers, attached either locally or over a network, have been detected on your computer. You can choose which printer you want to use:

1 Select the printer from the list.

2 Click **OK**.

Notices

Product information

Product name:

Lexmark 6500 Series

Machine type:

4429

Model(s):

021, W12, W1E

Edition notice

May 2007

The following paragraph does not apply to any country where such provisions are inconsistent with local law: LEXMARK INTERNATIONAL, INC., PROVIDES THIS PUBLICATION "AS IS" WITHOUT WARRANTY OF ANY KIND, EITHER EXPRESS OR IMPLIED, INCLUDING, BUT NOT LIMITED TO, THE IMPLIED WARRANTIES OF MERCHANTABILITY OR FITNESS FOR A PARTICULAR PURPOSE. Some states do not allow disclaimer of express or implied warranties in certain transactions; therefore, this statement may not apply to you.

This publication could include technical inaccuracies or typographical errors. Changes are periodically made to the information herein; these changes will be incorporated in later editions. Improvements or changes in the products or the programs described may be made at any time.

References in this publication to products, programs, or services do not imply that the manufacturer intends to make these available in all countries in which it operates. Any reference to a product, program, or service is not intended to state or imply that only that product, program, or service may be used. Any functionally equivalent product, program, or service that does not infringe any existing intellectual property right may be used instead. Evaluation and verification of operation in conjunction with other products, programs, or services, except those expressly designated by the manufacturer, are the user's responsibility.

For Lexmark technical support, visit support.lexmark.com.

For information on supplies and downloads, visit www.lexmark.com.

If you don't have access to the Internet, you can contact Lexmark by mail:

Lexmark International, Inc.
Bldg 004-2/CSC
740 New Circle Road NW
Lexington, KY 40550

© 2007 Lexmark International, Inc.

All rights reserved.

Trademarks

Lexmark and Lexmark with diamond design are trademarks of Lexmark International, Inc., registered in the United States and/or other countries.

evercolor and PerfectFinish are trademarks of Lexmark International, Inc.

TrueType is a trademark of Apple Inc.

All other trademarks are the property of their respective owners.

UNITED STATES GOVERNMENT RIGHTS

This software and any accompanying documentation provided under this agreement are commercial computer software and documentation developed exclusively at private expense.

Conventions

Note: A *Note* identifies something that could help you.

Warning: A *Warning* identifies something that could damage your product hardware or software.



CAUTION: A *CAUTION* identifies something that could cause you harm.



CAUTION: This type of *CAUTION* indicates that you should *not touch* the marked area.



CAUTION: This type of *CAUTION* indicates a *hot surface*.



CAUTION: This type of *CAUTION* indicates a *shock hazard*.



CAUTION: This type of *CAUTION* indicates a *tipping hazard*.

Federal Communications Commission (FCC) compliance information statement

This product has been tested and found to comply with the limits for a Class B digital device, pursuant to Part 15 of the FCC Rules. Operation is subject to the following two conditions: (1) this device may not cause harmful interference, and (2) this device must accept any interference received, including interference that may cause undesired operation.

The FCC Class B limits are designed to provide reasonable protection against harmful interference when the equipment is operated in a residential installation. This equipment generates, uses, and can radiate radio frequency energy and, if not installed and used in accordance with the instructions, may cause harmful interference to radio communications. However, there is no guarantee that interference will not occur in a particular installation. If this equipment does cause harmful interference to radio or television reception, which can be determined by turning the equipment off and on, the user is encouraged to try to correct the interference by one or more of the following measures:

- Reorient or relocate the receiving antenna.
- Increase the separation between the equipment and receiver.
- Connect the equipment into an outlet on a circuit different from that to which the receiver is connected.
- Consult your point of purchase or service representative for additional suggestions.

The manufacturer is not responsible for radio or television interference caused by using other than recommended cables or by unauthorized changes or modifications to this equipment. Unauthorized changes or modifications could void the user's authority to operate this equipment.

Note: To assure compliance with FCC regulations on electromagnetic interference for a Class B computing device, use a properly shielded and grounded cable such as Lexmark part number 1021294 for USB attach. Use of a substitute cable not properly shielded and grounded may result in a violation of FCC regulations.

Any questions regarding this compliance information statement should be directed to:

Director of Lexmark Technology & Services
Lexmark International, Inc.
740 West New Circle Road
Lexington, KY 40550
(859) 232-3000

Exposure to radio frequency radiation

The following notice is applicable if your printer has a wireless network card installed.

The radiated output power of this device is far below the radio frequency exposure limits of the FCC and other regulatory agencies. A minimum separation of 20 cm (8 inches) must be maintained between the antenna and any persons for this device to satisfy the RF exposure requirements of the FCC and other regulatory agencies.

Industry Canada compliance statement

This Class B digital apparatus meets all requirements of the Canadian Interference-Causing Equipment Standard ICES-003.

Avis de conformité aux normes de l'industrie du Canada

Cet appareil numérique de classe B est conforme aux exigences de la norme canadienne relative aux équipements pouvant causer des interférences NMB-003.

Industry Canada notice

The following notices are applicable if your printer has a wireless network card installed.

Industry Canada (Canada)

This device complies with Industry Canada specification RSS-210. Operation is subject to the following two conditions: (1) this device may not cause interference, and (2) this device must accept any interference, including interference that may cause undesired operation of the device.

This device has been designed to operate only with the antenna provided. Use of any other antenna is strictly prohibited per regulations of Industry Canada.

To prevent radio interference to the licensed service, this device is intended to be operated indoors and away from windows to provide maximum shielding. Equipment (or its transmit antenna) that is installed outdoors is subject to licensing.

The installer of this radio equipment must ensure that the antenna is located or pointed such that it does not emit RF fields in excess of Health Canada limits for the general population; consult Safety Code 6, obtainable from Health Canada's Web site www.hc-sc.gc.ca/rpb.

The term "IC:" before the certification/registration number only signifies that the Industry Canada technical specifications were met.

Industry Canada (Canada)

Cet appareil est conforme à la norme RSS-210 d'Industry Canada. Son fonctionnement est soumis aux deux conditions suivantes :

(1) cet appareil ne doit pas provoquer d'interférences et (2) il doit accepter toute interférence reçue, y compris celles risquant d'altérer son fonctionnement.

Cet appareil a été conçu pour fonctionner uniquement avec l'antenne fournie. L'utilisation de toute autre antenne est strictement interdite par la réglementation d'Industry Canada.

En application des réglementations d'Industry Canada, l'utilisation d'une antenne de gain supérieur est strictement interdite.

Pour empêcher toute interférence radio au service faisant l'objet d'une licence, cet appareil doit être utilisé à l'intérieur et loin des fenêtres afin de garantir une protection optimale.

Si le matériel (ou son antenne d'émission) est installé à l'extérieur, il doit faire l'objet d'une licence.

L'installateur de cet équipement radio doit veiller à ce que l'antenne soit implantée et dirigée de manière à n'émettre aucun champ HF dépassant les limites fixées pour l'ensemble de la population par Santé Canada. Reportez-vous au Code de sécurité 6 que vous pouvez consulter sur le site Web de Santé Canada www.hc-sc.gc.ca/rpb.

Le terme « IC » précédant le numéro de d'accréditation/inscription signifie simplement que le produit est conforme aux spécifications techniques d'Industry Canada.

European Community (EC) directives conformity

This product is in conformity with the protection requirements of EC Council directives 89/336/EEC, 2006/95/EC, and 1999/5/EC on the approximation and harmonization of the laws of the Member States relating to electromagnetic compatibility and safety of electrical equipment designed for use within certain voltage limits and on radio equipment and telecommunications terminal equipment.

A declaration of conformity with the requirements of the directives has been signed by the Director of Manufacturing and Technical Support, Lexmark International, Inc., S.A., Boigny, France.

This product satisfies the Class B limits of EN 55022 and safety requirements of EN 60950.

European EC directives conformity

The following notices are applicable if your printer has a wireless network card installed

This product is in conformity with the protection requirements of EC Council directives 89/336/EEC, 2006/95/EC, and 1999/5/EC on the approximation and harmonization of the laws of the Member States relating to electromagnetic compatibility, safety of electrical equipment designed for use within certain voltage limits and on radio equipment and telecommunications terminal equipment.

Compliance is indicated by the CE marking.



The Alert sign indicates that there are restrictions within certain member states.

A declaration of conformity with the requirements of the directives is available from the Director of Manufacturing and Technical Support, Lexmark International, S. A., Boigny, France.

The following restrictions apply:

Country/region	Restriction
All countries/regions	This product is for indoor use only. This product may not be used outdoors.
L'Italia	Si fa presente inoltre che l'uso degli apparati in esame è regolamentato da: <ul style="list-style-type: none"> • D.Lgs 1.8.2003, n.259, articoli 104 (attività soggette ad autorizzazione generale) e 105 (libero uso), per uso privato; • D.M. 28.5.03, per la fornitura al pubblico dell'accesso R-LAN alle reti e ai servizi di telecomunicazioni.

This product satisfies the limits of EN 55022; safety requirements of EN 60950; radio spectrum requirements of ETSI EN 300 328; and the EMC requirements of EN 55024, ETSI EN 301 489-1 and ETSI EN 301 489-17.

Česky	Společnost Lexmark International, Inc. tímto prohlašuje, že výrobek tento výrobek je ve shodě se základními požadavky a dalšími příslušnými ustanoveními směrnice 1999/5/ES.
Dansk	Lexmark International, Inc. erklærer herved, at dette produkt overholder de væsentlige krav og øvrige relevante krav i direktiv 1999/5/EF.
Deutsch	Hiermit erklärt Lexmark International, Inc., dass sich das Gerät dieses Gerät in Übereinstimmung mit den grundlegenden Anforderungen und den übrigen einschlägigen Bestimmungen der Richtlinie 1999/5/EG befindet.
Ελληνική	ΜΕ ΤΗΝ ΠΑΡΟΥΣΑ Η LEXMARK INTERNATIONAL, INC. ΔΗΛΩΝΕΙ ΟΤΙ ΑΥΤΟ ΤΟ ΠΡΟΪΟΝ ΣΥΜΜΟΡΦΩΝΕΤΑΙ ΠΡΟΣ ΤΙΣ ΟΥΣΙΩΔΕΙΣ ΑΠΑΙΤΗΣΕΙΣ ΚΑΙ ΤΙΣ ΛΟΙΠΕΣ ΣΧΕΤΙΚΕΣ ΔΙΑΤΑΞΕΙΣ ΤΗΣ ΟΔΗΓΙΑΣ 1999/5/ΕΚ.
English	Hereby, Lexmark International, Inc., declares that this type of equipment is in compliance with the essential requirements and other relevant provisions of Directive 1999/5/EC.
Español	Por medio de la presente, Lexmark International, Inc. declara que este producto cumple con los requisitos esenciales y cualesquiera otras disposiciones aplicables o exigibles de la Directiva 1999/5/CE.
Eesti	Käesolevaga kinnitab Lexmark International, Inc., et seade see toode vastab direktiivi 1999/5/EÜ põhinõuetele ja nimetatud direktiivist tulenevatele muudele asjakohastele sätetele.
Suomi	Lexmark International, Inc. vakuuttaa täten, että tämä tuote on direktiivin 1999/5/EY oleellisten vaatimusten ja muiden sitä koskevien direktiivin ehtojen mukainen.
Français	Par la présente, Lexmark International, Inc. déclare que l'appareil ce produit est conforme aux exigences fondamentales et autres dispositions pertinentes de la directive 1999/5/CE.
Magyar	Alulírott, Lexmark International, Inc. nyilatkozom, hogy a termék megfelel a vonatkozó alapvető követelményeknek és az 1999/5/EC irányelv egyéb előírásainak.
Íslenska	Hér með lýsir Lexmark International, Inc. yfir því að þessi vara er í samræmi við grunnkröfur og aðrar kröfur, sem gerðar eru í tilskipun 1999/5/EC.
Italiano	Con la presente Lexmark International, Inc. dichiara che questo questo prodotto è conforme ai requisiti essenziali ed alle altre disposizioni pertinenti stabilite dalla direttiva 1999/5/CE.
Latviski	Ar šo Lexmark International, Inc. deklarē, ka šis izstrādājums atbilst Direktīvas 1999/5/EK būtiskajām prasībām un citiem ar to saistītajiem noteikumiem.
Lietuvių	Šiuo Lexmark International, Inc. deklaruoja, kad šis produktas atitinka esminius reikalavimus ir kitas 1999/5/EB direktyvos nuostatas.
Malti	Bil-preżenti, Lexmark International, Inc., jiddikjara li dan il-prodott huwa konformi mal-ftiġijiet essenzjali u ma dispożizzjonijiet oħrajn relevanti li jinsabu fid-Direttiva 1999/5/KE.

Nederlands	Hierbij verklaart Lexmark International, Inc. dat het toestel dit product in overeenstemming is met de essentiële eisen en de andere relevante bepalingen van richtlijn 1999/5/EG.
Norsk	Lexmark International, Inc. erklærer herved at dette produktet er i samsvar med de grunnleggende krav og øvrige relevante krav i direktiv 1999/5/EF.
Polski	Niniejszym Lexmark International, Inc. oświadcza, że niniejszy produkt jest zgodny z zasadniczymi wymogami oraz pozostałymi stosownymi postanowieniami Dyrektywy 1999/5/EC.
Português	A Lexmark International Inc. declara que este produto está conforme com os requisitos essenciais e outras disposições da Diretiva 1999/5/CE.
Slovensky	Lexmark International, Inc. týmto vyhlasuje, že tento produkt spĺňa základné požiadavky a všetky príslušné ustanovenia smernice 1999/5/ES.
Slovensko	Lexmark International, Inc. izjavlja, da je ta izdelek v skladu z bistvenimi zahtevami in ostalimi relevantnimi določili direktive 1999/5/ES.
Svenska	Härmed intygar Lexmark International, Inc. att denna produkt står i överensstämmelse med de väsentliga egenskapskrav och övriga relevanta bestämmelser som framgår av direktiv 1999/5/EG.

Noise emission levels

The following measurements were made in accordance with ISO 7779 and reported in conformance with ISO 9296.

Note: Some modes may not apply to your product.

1-meter average sound pressure, dBA	
Printing	47
Scanning	44
Copying	42
Ready	inaudible

Values are subject to change. See www.lexmark.com for current values.

Product disposal

Do not dispose of the printer or supplies in the same manner as normal household waste. Consult your local authorities for disposal and recycling options.

Temperature information

Ambient temperature	60 to 90 degrees F, 15 to 32 degrees C
Shipping and storage temperature	-40 to 60 degrees C (-40 to 140 degrees F), 1 to 60 degrees C (34 to 140 degrees F)

Federal Communications Commission (FCC) compliance information statement

This equipment complies with Part 68 of the FCC rules and the requirements adopted by the Administrative Council for Terminal Attachments (ACTA). On the back of this equipment is a label that contains, among other information, a product identifier in the format US:AAAEQ##TXXXX. If requested, this number must be provided to your telephone company.

This equipment uses the RJ-11C Universal Service Order Code (USOC) jack.

A plug and jack used to connect this equipment to the premises' wiring and telephone network must comply with the applicable FCC Part 68 rules and requirements adopted by the ACTA. A compliant telephone cord and modular plug is provided with this product. It is designed to be connected to a compatible modular jack that is also compliant. See your setup documentation for more information.

The Ringer Equivalence Number (REN) is used to determine the number of devices that may be connected to a telephone line. Excessive RENs on a telephone line may result in the devices not ringing in response to an incoming call. In most but not all areas, the sum of RENs should not exceed five (5.0). To be certain of the number of devices that may be connected to a line, as determined by the total RENs, contact your local telephone company. For products approved after July 23, 2001, the REN for this product is part of the product identifier that has the format US:AAAEQ##TXXXX. The digits represented by ## are the REN without a decimal point (for example, 03 is a REN of 0.3). For earlier products, the REN is shown separately on the label.

If this equipment causes harm to the telephone network, the telephone company will notify you in advance that temporary discontinuance of service may be required. If advance notice is not practical, the telephone company will notify the customer as soon as possible. You will also be advised of your right to file a complaint with the FCC.

The telephone company may make changes in its facilities, equipment, operations or procedures that could affect the operation of this equipment. If this happens, the telephone company will provide advance notice in order for you to make necessary modifications to maintain uninterrupted service.

If you experience trouble with this equipment, for repair or warranty information, contact Lexmark International, Inc. at www.lexmark.com or your Lexmark representative. If the equipment is causing harm to the telephone network, the telephone company may request that you disconnect the equipment until the problem is resolved.

This equipment contains no user serviceable parts. For repair and warranty information, contact Lexmark International, Inc. See the previous paragraph for contact information.

Connection to party line service is subject to state tariffs. Contact the state public utility commission, public service commission, or corporation commission for information.

If your home has specially wired alarm equipment connected to the telephone line, ensure the installation of this equipment does not disable your alarm equipment. If you have questions about what will disable alarm equipment, consult your telephone company or a qualified installer.

Telephone companies report that electrical surges, typically lightning transients, are very destructive to customer terminal equipment connected to AC power sources. This has been identified as a major nationwide problem. It is recommended that the customer install an appropriate AC surge arrester in the AC outlet to which this device is connected. An appropriate AC surge arrester is defined as one that is suitably rated, and certified by UL (Underwriter's Laboratories), another NRTL (Nationally Recognized Testing Laboratory), or a recognized safety certification body in the country/region of use. This is to avoid damage to the equipment caused by local lightning strikes and other electrical surges.

The Telephone Consumer Protection Act of 1991 makes it unlawful for any person to use a computer or other electronic device, including fax machines, to send any message unless said message clearly contains in a margin at the top or bottom of each transmitted page or on the first page of the transmission, the date and time it is sent and an identification of the business or other entity, or other individual sending the message, and the telephone number of the sending machine or such business, other entity, or individual. (The telephone number provided may not be a 900 number or any other number for which charges exceed local or long-distance transmission charges.)

See your user documentation in order to program this information into your fax machine.

Notice to users of the Canadian telephone network

This product meets the applicable Industry Canada technical specifications. The Ringer Equivalence Number (REN) is an indication of the maximum number of terminals allowed to be connected to a telephone interface. The terminus of an interface may consist of any combination of devices, subject only to the requirement that the sum of the RENs of all the devices does not exceed five. The modem REN is located on the rear of the equipment on the product labeling.

Telephone companies report that electrical surges, typically lightning transients, are very destructive to customer terminal equipment connected to AC power sources. This has been identified as a major nationwide problem. It is recommended that the customer install an appropriate AC surge arrester in the AC outlet to which this device is connected. An appropriate AC surge arrester is defined as one that is suitably rated, and certified by UL (Underwriter's Laboratories), another NRTL (Nationally Recognized Testing Laboratory), or a recognized safety certification body in the country/region of use. This is to avoid damage to the equipment caused by local lightning strikes and other electrical surges.

This equipment uses CA11A telephone jacks.

Avis réservé aux utilisateurs du réseau téléphonique du Canada

Ce produit est conforme aux spécifications techniques d'Industrie Canada. Le numéro REN (ringer equivalence number : numéro d'équivalence de sonnerie) fournit une indication du nombre maximum de terminaux pouvant être connectés à l'interface téléphonique. En bout de ligne, le nombre d'appareils qui peuvent être connectés n'est pas directement limité, mais la somme des REN de ces appareils ne doit pas dépasser cinq. Le numéro REN du modem est indiqué sur l'étiquette produit située à l'arrière de l'équipement.

Les compagnies de téléphone constatent que les surtensions électriques, en particulier celles dues à la foudre, entraînent d'importants dégâts sur les terminaux privés connectés à des sources d'alimentation CA. Il s'agit-là d'un problème majeur d'échelle nationale. En conséquence, il vous est recommandé de brancher un parasurtenseur dans la prise de courant à laquelle l'équipement est connecté. Utilisez un parasurtenseur répondant à des caractéristiques nominales satisfaisantes et certifié par le laboratoire d'assureurs UL (Underwriter's Laboratories), un autre laboratoire agréé de type NRTL (Nationally Recognized Testing Laboratory) ou un organisme de certification agréé dans votre région ou pays. Ceci prévient tout endommagement de l'équipement causé par les orages et autres surtensions électriques.

Cet équipement utilise des prises de téléphone CA11A.

Notice to users of the New Zealand telephone network

The following are special conditions for the Facsimile User Instructions. The grant of a telepermit for any item of terminal equipment indicates only that Telecom has accepted that the item complies with minimum conditions for connection to its network. It indicates no endorsement of the product by Telecom, nor does it provide any sort of warranty. Above all, it provides no assurance that any item will work correctly in all respects with another item of telepermitted equipment of a different make or model, nor does it imply that any product is compatible with all of Telecom's network services.

This equipment shall not be set up to make automatic calls to the Telecom's 111 Emergency Service.

This equipment may not provide for the effective hand-over of a call to another device connected to the same line.

This equipment should not be used under any circumstances that may constitute a nuisance to other Telecom customers.

Some parameters required for compliance with Telecom's telepermit requirements are dependent on the equipment associated with this device. The associated equipment shall be set to operate within the following limits for compliance to Telecom's specifications:

- There shall be no more than 10 call attempts to the same number within any 30 minute period for any single manual call initiation, and
- The equipment shall go on-hook for a period of not less than 30 seconds between the end of one attempt and the beginning of the next call attempt.
- The equipment shall be set to ensure that automatic calls to different numbers are spaced such that there is not less than 5 seconds between the end of one call attempt and the beginning of another.

South Africa telecommunications notice

This modem must be used in conjunction with an approved surge protection device when connected to the PSTN.

Using this product in Switzerland

This product requires a Swiss billing tone filter (Lexmark part number 14B5109) to be installed on any line which receives metering pulses in Switzerland. The Lexmark filter must be used, as metering pulses are present on all analog telephone lines in Switzerland.

Utilisation de ce produit en Suisse

Cet appareil nécessite l'utilisation d'un filtre de tonalité de facturation suisse (n° de référence Lexmark : 14B5123) devant être installé sur toute ligne recevant des impulsions de comptage en Suisse. Ce filtre doit être utilisé pour toute installation car ces impulsions existent sur toutes les lignes téléphoniques suisses.

Verwendung dieses Produkts in der Schweiz

Für dieses Produkt muss ein schweizerischer Billing Tone Filter zur Zählzeichenübertragung (Lexmark Teilenummer 14B5109) für jede Leitung installiert werden, über die in der Schweiz Zeitsteuertakte übertragen werden. Die Verwendung des Lexmark Filters ist obligatorisch, da in allen analogen Telefonleitungen in der Schweiz Zeitsteuertakte vorhanden sind.

Uso del prodotto in Svizzera

Questo prodotto richiede un filtro toni Billing svizzero, (codice Lexmark 14B5109), da installare su tutte le linee che ricevono impulsi remoti in Svizzera. È necessario utilizzare il filtro Lexmark poiché gli impulsi remoti sono presenti su tutte le linee analogiche in Svizzera.

ENERGY STAR



Waste from Electrical and Electronic Equipment (WEEE) directive



The WEEE logo signifies specific recycling programs and procedures for electronic products in countries of the European Union. We encourage the recycling of our products. If you have further questions about recycling options, visit the Lexmark Web site at www.lexmark.com for your local sales office phone number.

Power consumption

Product power consumption

The following table documents the power consumption characteristics of the product.

Note: Some modes may not apply to your product.

Mode	Description	Power consumption (Watts)
Printing	The product is generating hard-copy output from electronic inputs.	14.1
Copying	The product is generating hard-copy output from hard-copy original documents.	13.2
Scanning	The product is scanning hard-copy documents.	9.0
Ready	The product is waiting for a print job.	6.9
Power Saver	The product is in energy-saving mode.	3.5
High Off	The product is plugged into a wall outlet, but the power switch is turned off.	n/a
Low Off (<1 W Off)	The product is plugged into a wall outlet, the power switch is turned off, and the product is in the lowest possible power consumption mode.	n/a
Off	The product is plugged into a wall outlet, but the power switch is turned off.	0.5

The power consumption levels listed in the previous table represent time-averaged measurements. Instantaneous power draws may be substantially higher than the average.

Values are subject to change. See www.lexmark.com for current values.

Power Saver

This product is designed with an energy-saving mode called Power Saver. The Power Saver Mode is equivalent to the EPA Sleep Mode. The Power Saver Mode saves energy by lowering power consumption during extended periods of inactivity. The Power Saver Mode is automatically engaged after this product is not used for a specified period of time, called the Power Saver Timeout.

Factory default Power Saver Timeout for this product (in minutes):	60
--	----

Off mode

If this product has an off mode which still consumes a small amount of power, then to completely stop product power consumption, disconnect the power supply cord from the wall outlet.

Total energy usage

It is sometimes helpful to calculate the total product energy usage. Since power consumption claims are provided in power units of Watts, the power consumption should be multiplied by the time the product spends in each mode in order to calculate energy usage. The total product energy usage is the sum of each mode's energy usage.

Statement of Limited Warranty

Lexmark International, Inc., Lexington, KY

This limited warranty applies to the United States. For customers outside the U.S., see the country-specific warranty information that came with your product.

This limited warranty applies to this product only if it was originally purchased for your use, and not for resale, from Lexmark or a Lexmark remarketer, referred to in this statement as "Remarketer."

Limited warranty

Lexmark warrants that this product:

- Is manufactured from new parts, or new and serviceable used parts, which perform like new parts
- Is, during normal use, free from defects in material and workmanship

If this product does not function as warranted during the warranty period, contact a Remarketer or Lexmark for repair or replacement (at Lexmark's option).

If this product is a feature or option, this statement applies only when that feature or option is used with the product for which it was designed. To obtain warranty service, you may be required to present the feature or option with the product.

If you transfer this product to another user, warranty service under the terms of this statement is available to that user for the remainder of the warranty period. You should transfer proof of original purchase and this statement to that user.

Limited warranty service

The warranty period starts on the date of original purchase as shown on the purchase receipt. The warranty period ends 12 months later.

To obtain warranty service you may be required to present proof of original purchase. You may be required to deliver your product to the Remarketer or Lexmark, or ship it prepaid and suitably packaged to a Lexmark designated location. You are responsible for loss of, or damage to, a product in transit to the Remarketer or the designated location.

When warranty service involves the exchange of a product or part, the item replaced becomes the property of the Remarketer or Lexmark. The replacement may be a new or repaired item. The replacement item assumes the remaining warranty period of the original product.

Replacement is not available to you if the product you present for exchange is defaced, altered, in need of a repair not included in warranty service, damaged beyond repair, or if the product is not free of all legal obligations, restrictions, liens, and encumbrances.

Before you present this product for warranty service, remove all print cartridges, programs, data, and removable storage media (unless directed otherwise by Lexmark).

For further explanation of your warranty alternatives and the nearest Lexmark authorized servicer in your area, contact Lexmark at (800) 332-4120, or on the World Wide Web at <http://support.lexmark.com>.

Remote technical support is provided for this product throughout its warranty period. For products no longer covered by a Lexmark warranty, technical support may not be available or only be available for a fee.

Extent of limited warranty

We do not warrant uninterrupted or error-free operation of any product.

Warranty service does not include repair of failures caused by:

- Modification or attachments
- Accidents or misuse
- Unsuitable physical or operating environment
- Maintenance by anyone other than Lexmark or a Lexmark authorized servicer

- Operation of a product beyond the limit of its duty cycle
- Use of printing media outside of Lexmark specifications
- Supplies (such as ink) not furnished by Lexmark
- Products, components, parts, materials, software, or interfaces not furnished by Lexmark

TO THE EXTENT PERMITTED BY APPLICABLE LAW, NEITHER LEXMARK NOR ITS THIRD PARTY SUPPLIERS OR REMARKETERS MAKE ANY OTHER WARRANTY OR CONDITION OF ANY KIND, WHETHER EXPRESS OR IMPLIED, WITH RESPECT TO THIS PRODUCT, AND SPECIFICALLY DISCLAIM THE IMPLIED WARRANTIES OR CONDITIONS OF MERCHANTABILITY, FITNESS FOR A PARTICULAR PURPOSE, AND SATISFACTORY QUALITY. ANY WARRANTIES THAT MAY NOT BE DISCLAIMED UNDER APPLICABLE LAW ARE LIMITED IN DURATION TO THE WARRANTY PERIOD. NO WARRANTIES, EXPRESS OR IMPLIED, WILL APPLY AFTER THIS PERIOD. ALL INFORMATION, SPECIFICATIONS, PRICES, AND SERVICES ARE SUBJECT TO CHANGE AT ANY TIME WITHOUT NOTICE.

Limitation of liability

Your sole remedy under this limited warranty is set forth in this document. For any claim concerning performance or nonperformance of Lexmark or a Remarketer for this product under this limited warranty, you may recover actual damages up to the limit set forth in the following paragraph.

Lexmark's liability for actual damages from any cause whatsoever will be limited to the amount you paid for the product that caused the damages. This limitation of liability will not apply to claims by you for bodily injury or damage to real property or tangible personal property for which Lexmark is legally liable. IN NO EVENT WILL LEXMARK BE LIABLE FOR ANY LOST PROFITS, LOST SAVINGS, INCIDENTAL DAMAGE, OR OTHER ECONOMIC OR CONSEQUENTIAL DAMAGES. This is true even if you advise Lexmark or a Remarketer of the possibility of such damages. Lexmark is not liable for any claim by you based on a third party claim.

This limitation of remedies also applies to claims against any Suppliers and Remarketers of Lexmark. Lexmark's and its Suppliers' and Remarketers' limitations of remedies are not cumulative. Such Suppliers and Remarketers are intended beneficiaries of this limitation.

Additional rights

Some states do not allow limitations on how long an implied warranty lasts, or do not allow the exclusion or limitation of incidental or consequential damages, so the limitations or exclusions contained above may not apply to you.

This limited warranty gives you specific legal rights. You may also have other rights that vary from state to state.

LEXMARK LICENSE AGREEMENTS

PLEASE READ CAREFULLY: BY USING THIS PRODUCT, YOU AGREE TO BE BOUND BY ALL THE TERMS AND CONDITIONS OF THESE LICENSE AGREEMENTS. IF YOU DO NOT AGREE WITH THE TERMS OF THESE LICENSE AGREEMENTS, PROMPTLY RETURN THE PRODUCT UNUSED AND REQUEST A REFUND OF THE AMOUNT YOU PAID. IF YOU ARE INSTALLING THIS PRODUCT FOR USE BY OTHER PARTIES, YOU AGREE TO INFORM THE USERS THAT USE OF THE PRODUCT INDICATES ACCEPTANCE OF THESE TERMS.

CARTRIDGE LICENSE AGREEMENT

I agree that the patented print cartridge(s) shipped with this printing device are sold subject to the following license/agreement: The patented print cartridge(s) contained inside is/are licensed for a single use only and is/are designed to stop working after delivering a fixed amount of ink. A variable amount of ink will remain in the cartridge when replacement is required. After this single use, the license to use the print cartridge terminates, and the used cartridge must be returned only to Lexmark for remanufacturing, refilling or recycling. If I buy another cartridge in the future that is sold subject to the above terms, I accept such terms as to that cartridge. If you do not accept the terms of this single use license/agreement; return this product in its original packaging to your point of purchase. A replacement cartridge sold without these terms is available at www.lexmark.com.

LEXMARK SOFTWARE LICENSE AGREEMENT

This Software License Agreement ("License Agreement") is a legal agreement between you (either an individual or a single entity) and Lexmark International, Inc. ("Lexmark") that, to the extent your Lexmark product or Software Program is not otherwise subject to a written software license agreement between you and Lexmark or its suppliers, governs your use of any Software Program installed on or provided by Lexmark for use in connection with your Lexmark product. The term "Software Program" includes machine-readable instructions, audio/visual content (such as images and recordings), and associated media, printed materials and electronic documentation, whether incorporated into, distributed with or for use with your Lexmark product.

- 1 STATEMENT OF LIMITED WARRANTY.** Lexmark warrants that the media (e.g., diskette or compact disk) on which the Software Program (if any) is furnished is free from defects in materials and workmanship under normal use during the warranty period. The warranty period is ninety (90) days and commences on the date the Software Program is delivered to the original end-user. This limited warranty applies only to Software Program media purchased new from Lexmark or an Authorized Lexmark Reseller or Distributor. Lexmark will replace the Software Program should it be determined that the media does not conform to this limited warranty.
- 2 DISCLAIMER AND LIMITATION OF WARRANTIES.** EXCEPT AS PROVIDED IN THIS LICENSE AGREEMENT AND TO THE MAXIMUM EXTENT PERMITTED BY APPLICABLE LAW, LEXMARK AND ITS SUPPLIERS PROVIDE THE SOFTWARE PROGRAM "AS IS" AND HEREBY DISCLAIM ALL OTHER WARRANTIES AND CONDITIONS, EITHER EXPRESS OR IMPLIED, INCLUDING, BUT NOT LIMITED TO, TITLE, NON-INFRINGEMENT, MERCHANTABILITY AND FITNESS FOR A PARTICULAR PURPOSE, AND ABSENCE OF VIRUSES, ALL WITH REGARD TO THE SOFTWARE PROGRAM. This Agreement is to be read in conjunction with certain statutory provisions, as that may be in force from time to time, that imply warranties or conditions or impose obligations on Lexmark that cannot be excluded or modified. If any such provisions apply, then to the extent Lexmark is able, Lexmark hereby limits its liability for breach of those provisions to one of the following: replacement of the Software Program or reimbursement of the price paid for the Software Program.
- 3 LICENSE GRANT.** Lexmark grants you the following rights provided you comply with all terms and conditions of this License Agreement:
- a Use.** You may Use one (1) copy of the Software Program. The term "Use" means storing, loading, installing, executing, or displaying the Software Program. If Lexmark has licensed the Software Program to you for concurrent use, you must limit the number of authorized users to the number specified in your agreement with Lexmark. You may not separate the components of the Software Program for use on more than one computer. You agree that you will not Use the Software Program, in whole or in part, in any manner that has the effect of overriding, modifying, eliminating, obscuring, altering or de-emphasizing the visual appearance of any trademark, trade name, trade dress or intellectual property notice that appears on any computer display screens normally generated by, or as a result of, the Software Program.
 - b Copying.** You may make one (1) copy of the Software Program solely for purposes of backup, archiving, or installation, provided the copy contains all of the original Software Program's proprietary notices. You may not copy the Software Program to any public or distributed network.
 - c Reservation of Rights.** The Software Program, including all fonts, is copyrighted and owned by Lexmark International, Inc. and/or its suppliers. Lexmark reserves all rights not expressly granted to you in this License Agreement.
 - d Freeware.** Notwithstanding the terms and conditions of this License Agreement, all or any portion of the Software Program that constitutes software provided under public license by third parties ("Freeware") is licensed to you subject to the terms and conditions of the software license agreement accompanying such Freeware, whether in the form of a discrete agreement, shrink-wrap license, or electronic license terms at the time of download. Use of the Freeware by you shall be governed entirely by the terms and conditions of such license.
- 4 TRANSFER.** You may transfer the Software Program to another end-user. Any transfer must include all software components, media, printed materials, and this License Agreement and you may not retain copies of the Software Program or components thereof. The transfer may not be an indirect transfer, such as a consignment. Prior to the transfer, the end-user receiving the transferred Software Program must agree to all these License Agreement terms. Upon transfer of the Software Program, your license is automatically terminated. You may not rent, sublicense, or assign the Software Program except to the extent provided in this License Agreement, and any attempt to do so shall be void.
- 5 UPGRADES.** To Use a Software Program identified as an upgrade, you must first be licensed to the original Software Program identified by Lexmark as eligible for the upgrade. After upgrading, you may no longer use the original Software Program that formed the basis for your upgrade eligibility.
- 6 LIMITATION ON REVERSE ENGINEERING.** You may not alter, decrypt, reverse engineer, reverse assemble, reverse compile or otherwise translate the Software Program, except as and to the extent expressly permitted to do so by applicable law for the purposes of inter-operability, error correction, and security testing. If you have such statutory rights, you will notify Lexmark in writing of any intended reverse engineering, reverse assembly, or reverse compilation. You may not decrypt the Software Program unless necessary for the legitimate Use of the Software Program.
- 7 ADDITIONAL SOFTWARE.** This License Agreement applies to updates or supplements to the original Software Program provided by Lexmark unless Lexmark provides other terms along with the update or supplement.
- 8 LIMITATION OF REMEDIES.** To the maximum extent permitted by applicable law, the entire liability of Lexmark, its suppliers, affiliates, and resellers, and your exclusive remedy shall be as follows: Lexmark will provide the express limited warranty described above. If Lexmark does not remedy defective media as warranted, you may terminate your license and your money will be refunded upon the return of all of your copies of the Software Program.

9 LIMITATION OF LIABILITY. To the maximum extent permitted by applicable law, for any claim arising out of Lexmark's limited warranty, or for any other claim whatsoever related to the subject matter of this Agreement, Lexmark's and its suppliers' liability for all types of damages, regardless of the form of action or basis (including contract, breach, estoppel, negligence, misrepresentation, or tort), shall be limited to the greater of \$5,000 or the money paid to Lexmark or its Authorized remarketers for the license hereunder for the Software Program that caused the damages or that is the subject matter of, or is directly related to, the cause of action.

IN NO EVENT WILL LEXMARK, ITS SUPPLIERS, SUBSIDIARIES, OR RESELLERS BE LIABLE FOR ANY SPECIAL, INCIDENTAL, INDIRECT, EXEMPLARY, PUNITIVE, OR CONSEQUENTIAL DAMAGES (INCLUDING BUT NOT LIMITED TO LOST PROFITS OR REVENUES, LOST SAVINGS, INTERRUPTION OF USE OR ANY LOSS OF, INACCURACY IN, OR DAMAGE TO, DATA OR RECORDS, FOR CLAIMS OF THIRD PARTIES, OR DAMAGE TO REAL OR TANGIBLE PROPERTY, FOR LOSS OF PRIVACY ARISING OUT OR IN ANY WAY RELATED TO THE USE OF OR INABILITY TO USE THE SOFTWARE PROGRAM, OR OTHERWISE IN CONNECTION WITH ANY PROVISION OF THIS LICENSE AGREEMENT), REGARDLESS OF THE NATURE OF THE CLAIM, INCLUDING BUT NOT LIMITED TO BREACH OF WARRANTY OR CONTRACT, TORT (INCLUDING NEGLIGENCE OR STRICT LIABILITY), AND EVEN IF LEXMARK, OR ITS SUPPLIERS, AFFILIATES, OR REMARKETERS HAVE BEEN ADVISED OF THE POSSIBILITY OF SUCH DAMAGES, OR FOR ANY CLAIM BY YOU BASED ON A THIRD-PARTY CLAIM, EXCEPT TO THE EXTENT THIS EXCLUSION OF DAMAGES IS DETERMINED LEGALLY INVALID. THE FOREGOING LIMITATIONS APPLY EVEN IF THE ABOVE-STATED REMEDIES FAIL OF THEIR ESSENTIAL PURPOSE.

- 10 TERM.** This License Agreement is effective unless terminated or rejected. You may reject or terminate this license at any time by destroying all copies of the Software Program, together with all modifications, documentation, and merged portions in any form, or as otherwise described herein. Lexmark may terminate your license upon notice if you fail to comply with any of the terms of this License Agreement. Upon such termination, you agree to destroy all copies of the Software Program together with all modifications, documentation, and merged portions in any form.
- 11 TAXES.** You agree that you are responsible for payment of any taxes including, without limitation, any goods and services and personal property taxes, resulting from this Agreement or your Use of the Software Program.
- 12 LIMITATION ON ACTIONS.** No action, regardless of form, arising out of this Agreement may be brought by either party more than two years after the cause of action has arisen, except as provided under applicable law.
- 13 APPLICABLE LAW.** This Agreement is governed by the laws of the Commonwealth of Kentucky, United States of America. No choice of law rules in any jurisdiction shall apply. The UN Convention on Contracts for the International Sale of Goods shall not apply.
- 14 UNITED STATES GOVERNMENT RESTRICTED RIGHTS.** The Software Program has been developed entirely at private expense. Rights of the United States Government to use the Software Program is as set forth in this Agreement and as restricted in DFARS 252.227-7014 and in similar FAR provisions (or any equivalent agency regulation or contract clause).
- 15 CONSENT TO USE OF DATA.** You agree that Lexmark, its affiliates, and agents may collect and use information you provide in relation to support services performed with respect to the Software Program and requested by you. Lexmark agrees not to use this information in a form that personally identifies you except to the extent necessary to provide such services.
- 16 EXPORT RESTRICTIONS.** You may not (a) acquire, ship, transfer, or reexport, directly or indirectly, the Software Program or any direct product therefrom, in violation of any applicable export laws or (b) permit the Software Program to be used for any purpose prohibited by such export laws, including, without limitation, nuclear, chemical, or biological weapons proliferation.
- 17 AGREEMENT TO CONTRACT ELECTRONICALLY.** You and Lexmark agree to form this License Agreement electronically. This means that when you click the "Agree" or "Yes" button on this page or use this product, you acknowledge your agreement to these License Agreement terms and conditions and that you are doing so with the intent to "sign" a contract with Lexmark.
- 18 CAPACITY AND AUTHORITY TO CONTRACT.** You represent that you are of the legal age of majority in the place you sign this License Agreement and, if applicable, you are duly authorized by your employer or principal to enter into this contract.
- 19 ENTIRE AGREEMENT.** This License Agreement (including any addendum or amendment to this License Agreement that is included with the Software Program) is the entire agreement between you and Lexmark relating to the Software Program. Except as otherwise provided for herein, these terms and conditions supersede all prior or contemporaneous oral or written communications, proposals, and representations with respect to the Software Program or any other subject matter covered by this License Agreement (except to the extent such extraneous terms do not conflict with the terms of this License Agreement, any other written agreement signed by you and Lexmark relating to your Use of the Software Program). To the extent any Lexmark policies or programs for support services conflict with the terms of this License Agreement, the terms of this License Agreement shall control.

Networking glossary

ad hoc mode	A setting for a wireless device that lets it communicate directly with other wireless devices without an access point or router
ad hoc network	A wireless network that does not use an access point
AutoIP address	An IP address automatically assigned by a network device. If the device is set to use DHCP, but no DHCP server is available, an AutoIP address may be assigned by the device.
BSS (Basic Service Set)	Basic Service Set describes the type of wireless network that you are using. The BSS type can be one of the following: Infrastructure network or Ad-Hoc network.
channel	A specific radio frequency used by two or more wireless devices to communicate with each other. All devices on the network must use the same channel.
DHCP (Dynamic Host Configuration Protocol)	A language used by DHCP servers
DHCP IP address	An IP address automatically assigned by a DHCP server
DHCP server	A computer or router that gives a unique IP address to each device on the network. Unique addresses prevent conflicts.
infrastructure mode	A setting for a wireless device that lets it communicate directly with other wireless devices using an access point or router
installation cable	Connects the printer to the computer temporarily during some methods of installation.
internal wireless print server	A device that lets computers and printers talk to each other over a network without cables
IP (Internet Protocol) address	The network address of a computer or printer. Each device on the network has its own network address. The address may be assigned manually by you (Static IP address), automatically by the DHCP server (DHCP IP address), or automatically by the device (AutoIP address).
ipconfig	A command that displays the IP address and other network information of a Windows computer
MAC (Media Access Control) address	A hardware address that uniquely identifies each device on a network. You can usually find the MAC address printed on the device.
MAC filtering	A method of limiting access to your wireless network by specifying which MAC addresses may communicate on the network. This setting may be specified on wireless routers or access points.
network adapter/card	A device that lets computers or printers talk to each other over a network
network hub	A device that connects multiple devices on a wired network
network name	See “SSID (Service Set Identifier)” on page 212
ping	A test to see if your computer can communicate with another device
printer nickname	The name you assign to your printer so that you and others can identify it on the network
router	A device that shares a single Internet connection with multiple computers or other devices. The basic router controls network traffic.
security key	A password, such as a WEP key or a WPA pass phrase, used to make a network secure
signal strength	Measure of how strongly a transmitted signal is being received
SSID (Service Set Identifier)	The name of a wireless network. When you connect a printer to a wireless network, the printer needs to use the same SSID as the network. Also referred to as network name or BSS (Basic Service Set).
Static IP address	An IP address assigned manually by you
switch	A device similar to a network hub that can connect different networks together

UAA (Universally Administered Address)	An address assigned to a network printer or print server by the manufacturer. To find the UAA, print a network setup page and look for the UAA listing.
USB cable	A lightweight, flexible cable that lets the printer communicate with the computer at much higher speeds than parallel cables
USB port	A small, rectangular port on the back of the computer that connects the peripheral devices using a USB cable, and lets them communicate at high speeds
WEP (Wired Equivalent Privacy)	A security setting that helps prevent unauthorized access to a wireless network. Other possible security settings are WPA and WPA2.
wireless access point	A device that connects wireless devices together to form a wireless network
wireless router	A router that also serves as a wireless access point
Wi-Fi	An industry term that describes the technology used to create an interoperable wireless local area network (WLAN).
WPA (Wi-Fi Protected Access)	A security setting that helps prevent unauthorized access to a wireless network. WPA is not supported on ad hoc wireless networks. Other possible security settings are WEP and WPA2.
WPA2	A newer version of WPA. Older routers are less likely to support this. Other possible security settings are WPA and WEP.

Index

Numerics

2-sided paper type error 196

A

ad hoc wireless network
 adding a printer using
 Windows 59
 creating using Windows 57
adjusting brightness
 automatically 88, 90
 adjusting the hue of a photo 89
 adjusting the saturation of a
 photo 89
Advanced button 45
aligning print cartridges 133
alignment error 191
answering machine
 receiving a fax with 117
assigning IP address 54
Auto Answer 124
Automatic Document Feeder
 loading documents 65
 paper capacity 65
 tray 18
automatic document feeder
 clearing a paper jam in 175
Automatic Document Feeder
(ADF) 18
 output tray 18
 paper guide 18

B

banner paper jams 174
banner paper, loading 63
banner printing problems
 checking spool settings 164
banner, printing 74
bidirectional communication,
 establishing 170
black ink low 192
blank or incorrect page prints 159
blocking host fax settings 126
blurring photo 88
booklet, assembling 73
booklets
 printing 73
borderless copying
 using the control panel 102
box contents 17
Brightness
 automatic adjustment 88, 90

Brightness / Contrast setting

 changing 90
broadcast fax, sending
 at a scheduled time 115
 immediately 114
buttons, control panel
 Auto Answer 39
 Back 38
 Cancel 38
 Copy Mode 37
 Fax Mode 37
 keypad 39
 Left arrow 38
 Lighter / Darker 37
 Menu 37
 Phone Book 39
 Photo Card 37
 Power 37
 Redial / Pause 39
 Right arrow 38
 Scan Mode 37
 Select 38
 Settings 37
 Start Black 39
 Start Color 39
 Two-sided (Duplex) 37

buttons, Productivity Studio

 Copy 44
 E-mail 44
 Fax 44
 Photo Greeting Cards 44
 Photo Packages 44
 Poster 44
 Scan 44
 Transfer Photos 44
 using 44

buttons, Solution Center

 Advanced 45
 How To 45
 Maintenance 45
 Troubleshooting 45
 using 45

C

cable connections
 checking 165, 167
Caller ID
 changing using control panel 188
Caller ID not displayed 188
Caller ID, using 116, 117

calling card

 using when faxing 113
 using when setting up Speed
 Dial 128
 using while listening to call 115
 using with On Hook dial
 feature 115
 using with the Fax Setup
 Utility 120
camera, connecting 81
can receive but not send fax 185
can send but not receive fax 185
canceling
 scan job 108
canceling print jobs 70
cannot print documents from a flash
drive 172
cannot print from digital camera
 using PictBridge 140
cannot print to network printer 171
cannot scan to computer over
network 182
cannot send or receive fax 183
cards

 loading 62
 memory 78
 printing 71
carrier jam error 192
cartridge error 192
cartridge missing error 197
cartridges, print
 aligning 133
 cleaning 133
 installing 130
 ordering 135
 preserving 134
 removing 130
 using genuine Lexmark 132
 wiping 133

CD

 printing photos from 91
 transferring all photos using
 computer 84
 transferring selected photos using
 the computer 85
changing
 temporary files preferences 86
changing e-mail screen
 preferences 112
changing gamma value of a photo
or image 89

- changing library preferences 87
 - Changing photo resolution/size 87
 - changing scan settings 110
 - changing searched folders preferences 86
 - changing temporary files preferences 86
 - changing transfer settings 87
 - changing wireless settings after installation 149
 - characters on printout are missing or unexpected 159
 - check printer ports (Windows) 153
 - checking external devices 167
 - checking printer readiness 164
 - checking your network name (Windows) 151
 - cleaning
 - exterior of the printer 135
 - cleaning print cartridge nozzles 133
 - collating copies 103
 - color effects
 - applying 90
 - color effects, applying to photos 96
 - color ink low 192
 - colors on paper do not match colors on the screen 160
 - communication not available error 197
 - communication problems
 - establishing bidirectional communication 170
 - connecting
 - using RJ11 adapter 27
 - connecting cables 165, 167
 - connecting the printer to
 - answering machine 30
 - computer modem 33
 - telephone 34
 - telephone wall jack 32
 - telephone wall jack in Germany 32
 - contents, box 17
 - control panel 18
 - Copy menu 98
 - Fax menu 123
 - installing another language 42
 - Photo Card menu 80
 - PictBridge menu 82
 - saving settings 39
 - Scan menu 108
 - Settings menu 40
 - using 36
- copied item does not match original 180
 - copier does not respond 178
 - Copy button 44
 - Copy menu 98
 - copy quality, adjusting 101
 - copy settings
 - modifying 104
 - copy troubleshooting
 - copied item does not match original 180
 - copier does not respond 178
 - partial document or photo copies 180
 - poor copy quality 179
 - scanner unit does not close 178
 - copying
 - adjusting quality 101
 - borderless photos 102
 - cloning an image 103
 - collating copies 103
 - customizing settings 98
 - enlarging an image 104
 - making a copy lighter or darker 102
 - on both sides of paper 99
 - on both sides of paper using ADF 99
 - photo using the computer 101
 - photos 100
 - reducing an image 104
 - repeating an image 103
 - could not detect a proof sheet 195
 - cover open 193
 - creating and viewing slideshow 97
 - creating fax cover page
 - using the Fax Setup Utility 120
 - using the Productivity Studio 125
 - cropping
 - photo 87
 - customizing settings
 - copy 98
 - fax 123
 - Fax Setup Utility 120
 - scan 108
 - custom-size paper, loading 63
 - custom-size paper, printing 73
- D**
- defaults
 - Photo Card menu 80
 - resetting factory defaults 172
 - resetting printer software to factory defaults 77
 - Settings menu 41
- descreening 90, 110
 - Despeckle
 - change setting 89
 - digital camera
 - printing photos using the computer 91
 - direct IP printing 52
 - distinctive ring patterns 127
 - documents
 - attaching to e-mail 111
 - e-mailing 111
 - faxing using the control panel 114
 - faxing using the software 113
 - loading into Automatic Document Feeder 65
 - loading on the scanner glass 63
 - printing 67
 - scanning images for editing 106
 - scanning text for editing 106
 - scanning using the computer 105
 - scanning using the control panel 105
 - duplex cover 19
 - duplexing
 - automatically 75
 - manually 76
 - understanding 75
 - duplexing copies 99
- E**
- editing
 - document text (OCR) 106
 - scanned images 106
 - emission
 - notices 201, 202, 203, 204
 - Enhancements tab
 - blur 88
 - enhance 89
 - hue 89
 - saturation 89
 - selecting color effect 90
 - sharpen 88
 - enhancing photo 89
 - enlarging an image 104
 - envelopes
 - loading 61
 - printing 71
 - error 1104 193
 - error 1205 193
 - error 1206 193
 - error messages
 - alignment error 191
 - black ink low 192

- cartridge error 192
- cartridge missing 197
- clear carrier jam 192
- clearing 197
- color ink low 192
- communication not available 197
- could not detect a proof sheet 195
- error 1104 193
- error 1205 193
- error 1206 193
- failed to connect 190
- fax error 188
- fax mode unsupported 188
- file not supported 196
- general printing problem 198
- ink low 198
- left cartridge error 193
- left cartridge incorrect 193
- left cartridge missing 194
- memory full 194
- no images have been selected 194
- no photo/paper size selection has been made 195
- no proof sheet information 195
- no valid photo image files detected 195
- only one photo enhancement may be chosen at a time 195
- only one photo/size selection can be chosen at a time 195
- out of memory 198
- out of paper 198
- paper jam 199
- paper/photo size error 195
- phone line busy 189
- phone line error 191
- photo ink low 192
- PictBridge communications error 196
- please remove the camera card 196
- printing failure 198
- problem reading memory card 196
- remote fax error 189
- right cartridge error 193
- right cartridge incorrect 193
- right cartridge missing 194
- some photos removed from card by host 196
- unsupported file types found on memory card 199
- unsupported paper size 197

- error messages troubleshooting
 - cover open error 193
- Exposure
 - changing setting 90
- EXT port 20
- exterior of the printer
 - cleaning 135
- external devices
 - checking 167
- e-mail
 - attaching a scanned image 111
 - attaching files 111
- E-mail button 44
- e-mail screen preferences
 - changing 112
- e-mailing an image 111

F

- factory default settings
 - resetting internal wireless print server 149
 - resetting printer software 77
- factory default settings, resetting to 172
- faded colors 160
- failed to connect error message 190
- fax
 - activity reports 129
 - confirmation reports 129
 - customizing settings 120
 - forwarding 118
 - receiving automatically 117
 - receiving manually 116
 - receiving with an answer code 116
 - setting a manual answer code 116
- Fax button 44
- fax cover page
 - creating using the Fax Setup Utility 120
 - creating using the Productivity Studio 125
- fax error 188
- fax footer, setting up
 - using the control panel 124
- Fax menu 123
- fax mode unsupported error message 188
- fax settings
 - blocking unwanted changes 126
 - changing using Fax Solutions Software 126

- Fax Setup Utility
 - Cover Page tab 120
 - customizing settings 120
 - Dialing and Sending tab 122
 - Fax Printing / Reports tab 122
 - Ringling and Answering tab 122
 - Speed Dial tab 122
 - using 120
- Fax Solutions Software, using 126
- fax troubleshooting
 - Caller ID not displayed 188
 - can receive but not send fax 185
 - can send but not receive fax 185
 - cannot send or receive fax 183
 - printer receives blank fax 187
 - received fax has poor print quality 187
- faxing
 - adding fax groups to Speed Dial 128
 - adding numbers to Speed Dial 128
 - Auto Answer 124
 - blocking unwanted faxes 125
 - changing settings 123
 - choosing a fax connection 30
 - cover page, creating using Productivity Studio 125
 - customizing settings 123
 - entering a fax number 113
 - sending a broadcast fax at a scheduled time 115
 - sending a broadcast fax immediately 114
 - sending while behind a PBX 36
 - setting Auto Answer to on 124
 - setting number of rings before automatic answering 128
 - setting up dialing prefix 127
 - using a calling card number 113
 - using digital telephone service 36
 - using DSL 36
 - using ISDN 36
 - using the control panel 114
 - using the software 113
 - while listening to call 115
- FCC notices 201, 204
- file not supported 196
- files
 - attaching to e-mail message 111
- finding
 - information 13
 - publications 13
 - Web site 13

- flash drive
 - inserting 79
 - printing files from 69
 - printing photos using the computer 91
 - printing photos using the proof sheet 93
 - transferring all photos using computer 84
 - transferring selected photos using the computer 85
- fonts
 - resolving problems 164
- forwarding a fax 118

G

- gamma value
 - changing 89
- general printing problem error 198
- getting a document to print 168
- glossy paper, loading 60
- glossy photo paper or transparencies stick together 160
- greeting cards
 - loading 62
 - printing 71
- Group Dial
 - setting up 128
 - using 113
 - using the Phone Book 119

H

- heavyweight matte paper, loading 60
- How To button 45

I

- image, changing gamma value 89
- images
 - e-mailing 111
- incorrect language appears on display 137
- index cards
 - loading 62
 - printing 71
- information, finding 13
- ink levels seem incorrect 158
- ink levels seem to go down quickly 159
- ink low error 198
- inserting
 - flash drives 79
 - memory cards 78
 - PictBridge-enabled digital camera 95

- installing
 - network printer 54
 - print cartridges 130
 - printer on a network 55
 - printer software 43, 141
 - software and sharing printer on network 55
- internal wireless print server
 - installing 47
- IP address, assigning 54
- iron-on transfers, loading 62
- iron-on transfers, printing 74

J

- jams and misfeeds troubleshooting
 - banner paper jams 174
 - paper jam in the automatic document feeder (ADF) 175
 - paper jam in the duplex unit 175
 - paper jam in the paper support 173
 - paper jam in the printer 173
 - paper or specialty media misfeeds 173
 - printer does not feed paper, envelopes, or specialty media 174
- junk faxes, blocking 125

L

- labels, loading 61
- language
 - changing 137
- last page first 69
- left cartridge error 193
- left cartridge incorrect 193
- left cartridge missing 194
- Lexmark Productivity Studio
 - creating and viewing slideshow 97
- library preferences
 - changing 87
- LINE port 19
- loading
 - banner paper 63
 - custom-size paper 63
 - documents into the Automatic Document Feeder 65
 - documents on the scanner glass 63
 - envelopes 61
 - glossy paper 60
 - greeting cards 62
 - heavyweight matte paper 60
 - index cards 62

- iron-on transfers 62
- labels 61
- paper 60
- photo cards 62
- photo paper 60
- photos on the scanner glass 63
- postcards 62
- transparencies 62

M

- MAC address 51
- magazine articles, loading on the scanner glass 63
- Maintenance button 45
- maintenance menus
 - Settings menu 41
- memory card
 - inserting 78
 - printing files from 69
 - printing photos using the computer 91
 - printing photos using the proof sheet 93
 - transferring all photos using the computer 83
 - transferring selected photos using the computer 84
- memory card cannot be inserted 176
- memory card slots 18
- memory card troubleshooting
 - memory card cannot be inserted 176
 - nothing happens when memory card is inserted 177
- memory full error message 194
- modifying copy settings 104
- moire patterns, removing from scanned images 90

N

- network adapters
 - using 57
- network printer
 - installing 54, 55
- network printer does not show up in printer selection list during installation (Windows) 144
- network printers
 - configuring 56
- network scanning 109
- network setup page, printing 52
- network troubleshooting
 - cannot print to network printer 171

- networking
 - configuring optional internal wireless print server 48
 - installing internal wireless print server 47
 - installing printer 55
 - IP addresses 54
 - using a print server 52
 - using the peer-to-peer method 56
 - using the point-and-print method 56
 - using wireless network connection 53
 - newspapers, loading on the scanner glass 63
 - no images selected error 194
 - no photo/paper size error 195
 - no proof sheet information error 195
 - no valid photo image files detected 195
 - noise emission levels 204
 - nothing happens when memory card is inserted 177
 - notices 201, 202, 203, 204, 207, 204, 205, 206, 207, 208
 - N-up feature 69
- O**
- OCR, editing document text 106
 - On Hook Dial feature 115
 - One-Click Auto Fix 88
 - only one photo enhancement may be chosen at a time 195
 - only one photo/size selection can be chosen at a time 195
 - ordering paper and other supplies 136
 - out of memory error 198
 - out of paper error 198
- P**
- page does not print 139
 - page prints with different fonts 160
 - paper
 - choosing specialty 71
 - paper and other supplies ordering 136
 - paper continues to jam 175
 - paper exit tray 18
 - paper feed guard 18
 - paper guides 18
 - paper jam error 199
 - paper jam in the automatic document feeder (ADF) 175
 - paper jam in the duplex unit 175
 - paper jam in the paper support 173
 - paper jam in the printer 173
 - paper or specialty media misfeeds 173
 - paper support 18
 - paper type
 - choosing automatically 60
 - paper, loading 60
 - paper/photo size error 195
 - partial 4x6in. (10x15cm) photo prints when using PictBridge 154
 - partial document or photo copies 180
 - partial document or photo prints 158
 - partial document or photo scans 182
 - parts
 - Automatic Document Feeder (ADF) 18
 - Automatic Document Feeder (ADF) output tray 18
 - Automatic Document Feeder (ADF) paper guide 18
 - Automatic Document Feeder (ADF) tray 18
 - control panel 18
 - duplex cover 19
 - EXT port 20
 - LINE port 19
 - memory card slots 18
 - paper exit tray 18
 - paper feed guard 18
 - paper guides 18
 - paper support 18
 - PictBridge port 18
 - power supply port 19
 - print cartridge carrier 19
 - scanner glass 19
 - scanner unit 19
 - top cover 19
 - USB port 20
 - Wi-Fi indicator 18
 - pausing print jobs 70
 - PDF
 - creating from a scan 107
 - peer-to-peer method 56
 - Phone Book (computer), using 120
 - Phone Book (control panel), using 119
 - phone line busy error message 189
 - phone line error 191
 - photo
 - adjusting hue 89
 - adjusting saturation 89
 - applying color effect 90
 - blurring 88
 - cropping 87
 - enhancing 89
 - sharpening 88
 - Photo Card menu 80
 - photo cards, loading 62
 - Photo Greeting Cards button 44
 - photo ink low 192
 - Photo Packages 92
 - Photo Packages button 44
 - photo paper, loading 60
 - Photo resolution/size
 - changing 87
 - photo scratches 158
 - photo smudges 158
 - photo, changing gamma value 89
 - photos
 - automatic red-eye reduction 88
 - copying borderless photos 102
 - copying photo using the computer 101
 - copying photos 100
 - loading on the scanner glass 63
 - printing all from a memory device 93
 - printing by date range 96
 - printing by number 94
 - printing from a Web page 68
 - printing from CD using the computer 91
 - printing from digital camera using DPOF 96
 - printing from digital camera using the computer 91
 - printing from PictBridge-enabled digital camera 95
 - printing from removable storage device using the computer 91
 - printing using color effects 96
 - printing using the proof sheet 93
 - red-eye reduction 88
 - rotating 87
 - scanning multiple photos at one time using computer 107
 - scanning to Work with Documents and Photos 106
 - scratches, preventing 158
 - smudges, preventing 158

- transferring all photos from CD or flash drive using computer 84
- transferring all photos from memory card using the computer 83
- transferring from memory card to flash drive 85
- transferring from memory device using control panel 83
- transferring selected photos from CD or flash drive using the computer 85
- transferring selected photos from memory card using the computer 84
- photos do not print from memory card across wireless network 177
- photos removed from card by host 196
- PictBridge communications error 196
- PictBridge menu 82
- PictBridge port 18
- PictBridge-enabled camera, connecting 81
- PictBridge-enabled camera, printing photos from 95
- ping the printer (Windows) 152
- ping the wireless access point (Windows) 152
- please remove the camera card 196
- point-and-print method 56
- poor copy quality 179
- poor quality at the edges of the page 156
- poor scanned image quality 182
- poor text and graphic quality 155
- port setting
 - checking 53
- postcards
 - loading 62
 - printing 71
- Poster button 44
- poster, printing 72
- posters, printing 72
- power button is not lit 138
- power supply port 19
- preferences, e-mail screen
 - changing 112
- preferences, library
 - changing 87
- preferences, searched folders
 - changing 86
- preferences, temporary files
 - changing 86
- print cartridge
 - checking 158
- print cartridge carrier 19
- print cartridge nozzles, cleaning 133
- print cartridges
 - aligning 133
 - cleaning 133
 - installing 130
 - ordering 135
 - preserving 134
 - refilling 132
 - removing 130
 - using genuine Lexmark 132
 - wiping 133
- print is dark or smudged 161
- print jobs
 - canceling 70
- print quality, improving 154
- print settings
 - saving and deleting 76
- print speed is slow 157
- print troubleshooting
 - cannot print documents from a flash drive 172
 - improving print quality 154
 - ink levels seem incorrect 158
 - ink levels seem to go down quickly 159
 - partial 4x6in. (10x15cm) photo prints when using PictBridge 154
 - partial document or photo prints 158
 - photo scratches 158
 - photo smudges 158
 - poor quality at the edges of the page 156
 - poor text and graphic quality 155
 - print speed is slow 157
- printed characters are improperly formed or not aligned 161
- printer
 - no communication 169
- printer cannot communicate over peer-to-peer network 168
- printer cannot connect to wireless network 150
- printer does not feed paper, envelopes, or specialty media 174
- printer plugged in but does not print 167
- printer receives blank fax 187
- printer software
 - installing 43
 - reinstalling 141
 - removing 141
 - updating 170
- printer status
 - checking 163
- printing
 - all photos from a memory device 93
 - banner 74
 - booklets 73
 - cards 71
 - collate 69
 - custom-size paper 73
 - document 67
 - envelopes 71
 - files from memory card or flash drive 69
 - greeting cards 71
 - improving print quality 154
 - index cards 71
 - iron-on transfers 74
 - last page first 69
 - multiple pages on one sheet 69
 - network setup page 52
 - on both sides of the paper 75, 76
 - Photo Packages 92
 - photos by date range 96
 - photos by number 94
 - photos from CD using the computer 91
 - photos from digital camera using DPOF 96
 - photos from digital camera using the computer 91
 - photos from PictBridge-enabled digital camera 95
 - photos from Productivity Studio 91
 - photos from removable storage device using the computer 91
 - photos from the Productivity Studio 91
 - photos using color effects 96
 - photos using the proof sheet 93
 - postcards 71
 - poster 72
 - posters 72
 - reverse page order 69
 - test page 165
 - transparencies 74
 - two-sided 75, 76
 - Web page 67
 - Web page, photos only 68

- printing failure error 198
- printouts have alternating bands of light and dark print 161
- problem reading memory card error 196
- problems when copying, scanning, or faxing 169
- Productivity Studio
 - printing photos 91
 - viewing photos 91
- Productivity Studio buttons
 - Copy 44
 - E-mail 44
 - Fax 44
 - Photo Greeting Cards 44
 - Photo Packages 44
 - Scan 44
 - Transfer Photos 44
 - understanding 44
- Productivity Studio, understanding 44
- proof sheet, using 93
- publications, finding 13

Q

- quality settings, checking 165
- Quick Fixes tab
 - using One-Click Auto Fix 88

R

- ready or busy printing is listed as status 165
- received fax has poor print quality 187
- receiving
 - two-sided fax 118
- receiving a fax
 - automatically 117
 - fax forwarding 118
 - manually 116
 - using an answering machine 117
 - with manual answer code 116
- recycling
 - WEEE statement 207
- reducing an image 104
- red-eye
 - automatic reduction 88
 - manual reduction 88
- refilling print cartridges 132
- remote fax error 189
- removing an external device 167
- removing print cartridges 130
- repeating an image 103
- reports
 - fax activity 129

- fax confirmation 129
- reverse page order 69
- right cartridge error 193
- right cartridge incorrect 193
- right cartridge missing 194
- ring patterns, setting 127
- RJ11 adapter 27
- rotating photo 87
- run the Wireless Setup Utility (Windows) 153

S

- safety information 2
- saving
 - paper size settings 80
 - paper type settings 80
 - photo size settings 80
- saving a scanned image 109
- saving and deleting print settings 76
- scan and edit text 106
- Scan button 44
- Scan Enhancements tab
 - Brightness / Contrast 90
 - Brightness / Contrast setting 90
 - Despeckle setting 89
 - Exposure setting 90
- Scan menu 108
- scan settings
 - changing 110
- scan troubleshooting
 - cannot scan to computer over network 182
 - partial document or photo scans 182
 - poor scanned image quality 182
 - scan was not successful 181
 - scanner does not respond 180
 - scanning takes too long or freezes the computer 181
 - scan was not successful 181
- scanned image
 - attaching to e-mail message 111
- scanned images
 - saving 109
- scanner does not respond 180
- scanner glass 19
 - cleaning 135
 - loading documents 63
- scanner unit 19
- scanner unit does not close 178
- scanning
 - canceling a scan 108
 - creating a PDF from a scan 107
 - customizing settings 108

- customizing settings using computer 108
- editing images 106
- editing text 106
- from magazines and newspapers 90, 110
- multiple photos at one time using computer 107
- over a network 109
- photo to Work with Documents and Photos 106
- removing wavy (moire) patterns 90
- to computer over a network 109
- using the computer 105
- using the control panel 105
- scanning takes too long or freezes the computer 181
- scratching, preventing in photos 158
- searched folders preferences
 - changing 86
- security information 48
- security keys 142
- setting up printer
 - on Windows operating system 26
- settings are not saved 163
- Settings menu
 - Defaults 40
 - Device Setup 41
 - Maintenance 40
 - Network Setup 42
 - Paper Setup 41
- settings, saving 39
- setup troubleshooting
 - cannot print from digital camera using PictBridge 140
 - incorrect language appears on display 137
 - page does not print 139
 - power button is not lit 138
 - software does not install 138
- shared printing
 - peer-to-peer method 55
 - point-and-print method 55
- sharpening photo 88
- slideshow
 - creating and viewing 97
- smudging, preventing in photos 158
- software
 - Fax Solutions Software 126
 - Productivity Studio 44
 - removing and reinstalling 141

- Solution Center 45
- software does not install 138
- software settings, printer
 - resetting to factory defaults 77
- Solution Center
 - understanding 45
- Solution Center buttons
 - Advanced 45
 - How To 45
 - Maintenance 45
 - Troubleshooting 45
 - understanding 45
- Speed Dial
 - setting up fax groups 128
 - setting up individual fax numbers 128
 - using 113
 - using the Phone Book 119
 - speed settings, checking 165

T

- telecommunication
 - notices 204, 205, 206
- test page
 - printing 165
- test page does not print 166
- Toolbar
 - printing a Web page 67
 - printing only the photos from a Web page 68
- top cover 19
- Transfer Photos button 44
- transfer settings
 - changing 87
- transferring photos
 - from CD using computer 84
 - from CD using the computer 85
 - from flash drive using computer 84
 - from flash drive using the computer 85
 - from memory card to flash drive 85
 - from memory card using the computer 83, 84
 - from memory device using control panel 83
- transparencies
 - loading 62
 - printing 74
- transparencies or photos contain white lines 162
- troubleshooting
 - 2-sided paper type error 196

- blank or incorrect page prints 159
- cartridge missing error 197
- characters on printout are missing or unexpected 159
- checking port setting 53
- checking printer status 163
- checking quality/speed settings 165
- colors on paper do not match colors on the screen 160
- communication not available error 197
- establishing bidirectional communication 170
- external devices, checking 167
- faded colors 160
- font selections 159
- general printing problem error 198
- getting document to print 168
- glossy photo paper or transparencies stick together 160
- ink low error 198
- out of memory error 198
- out of paper error 198
- page prints with different fonts 160
- paper continues to jam 175
- paper jam error 199
- port setting 53
- print is dark or smudged 161
- printed characters are improperly formed or not aligned 161
- printer cannot communicate over peer-to-peer network 168
- printer is trying to print to file 168
- printer not communicating with computer 169
- printer plugged in but does not print 167
- printer status 163
- printing failure error 198
- printouts have alternating bands of light and dark print 161
- problems when copying, scanning, or faxing 169
- ready or busy printing is listed as status 165
- removing an external device 167
- resolving font problems 164
- test page does not print 166
- transparencies or photos contain white lines 162

- unsupported file types found on memory card 199
- vertical straight lines are not smooth 162
- white lines appear in graphics or black areas 162
- wrong printer attached 170
- Troubleshooting button 45
- troubleshooting, copy
 - copied item does not match original 180
 - copier does not respond 178
 - partial document or photo copies 180
 - poor copy quality 179
 - scanner unit does not close 178
- troubleshooting, error messages
 - 2-sided paper type error 196
 - alignment error 191
 - black ink low 192
 - cartridge error 192
 - clear carrier jam 192
 - color ink low 192
 - could not detect a proof sheet 195
 - cover open 193
 - error 1104 193
 - error 1205 193
 - error 1206 193
 - failed to connect 190
 - fax error 188
 - fax mode unsupported 188
 - file not supported 196
 - left cartridge error 193
 - left cartridge incorrect 193
 - left cartridge missing 194
 - memory full 194
 - no images have been selected 194
 - no photo/paper size selection has been made 195
 - no proof sheet information 195
 - no valid photo image files detected 195
 - only one photo enhancement may be chosen at a time 195
 - only one photo/size selection can be chosen at a time 195
 - paper/photo size error 195
 - phone line busy 189
 - phone line error 191
 - photo ink low 192
 - PictBridge communications error 196

- please remove the camera card 196
- problem reading memory card 196
- remote fax error 189
- right cartridge error 193
- right cartridge incorrect 193
- right cartridge missing 194
- some photos removed from card by host 196
- unsupported paper size 197
- troubleshooting, fax
 - Caller ID not displayed 188
 - can receive but not send fax 185
 - can send but not receive fax 185
 - cannot send or receive fax 183
 - printer receives blank fax 187
 - received fax has poor print quality 187
- troubleshooting, jams and misfeeds
 - banner paper jams 174
 - paper jam in the automatic document feeder (ADF) 175
 - paper jam in the duplex unit 175
 - paper jam in the paper support 173
 - paper jam in the printer 173
 - paper or specialty media misfeeds 173
 - printer does not feed paper, envelopes, or specialty media 174
- troubleshooting, memory card
 - memory card cannot be inserted 176
 - nothing happens when memory card is inserted 177
- troubleshooting, network
 - cannot print to network printer 171
- troubleshooting, print
 - cannot print documents from a flash drive 172
 - improving print quality 154
 - ink levels seem incorrect 158
 - ink levels seem to go down quickly 159
 - partial 4x6in. (10x15cm) photo prints when using PictBridge 154
 - partial document or photo prints 158
 - photo scratches 158
 - photo smudges 158
- poor quality at the edges of the page 156
- poor text and graphic quality 155
- print speed is slow 157
- troubleshooting, scan
 - cannot scan to computer over network 182
 - partial document or photo scans 182
 - poor scanned image quality 182
 - scan was not successful 181
 - scanner does not respond 180
 - scanning takes too long or freezes the computer 181
- troubleshooting, setup
 - cannot print from digital camera using PictBridge 140
 - incorrect language appears on display 137
 - page does not print 139
 - power button is not lit 138
 - software does not install 138
- troubleshooting, wireless
 - changing wireless settings after installation 149
 - check printer ports (Windows) 153
 - checking network name (Windows) 151
 - network printer does not show up in printer selection list during installation (Windows) 144
 - photos do not print from memory card across wireless network 177
 - ping printer (Windows) 152
 - ping wireless access point (Windows) 152
 - printer cannot connect to wireless network 150
 - run Wireless Setup Utility (Windows) 153
 - wireless network printer does not print 143
 - wireless printer is no longer working 148
 - Wireless Setup Utility cannot communicate with printer during installation 151
 - Wi-Fi indicator is not lit 145
 - Wi-Fi indicator light is blinking orange 145
 - Wi-Fi indicator light is orange 147
- two-sided
 - 2-sided paper type error 196
 - copies, making 99
- two-sided fax
 - receiving 118
- two-sided printing
 - automatic method 75
 - manual method 76
 - understanding 75

U

- unsupported file types found on memory card 199
- unsupported paper size error message 197
- unwanted faxes, blocking 125
- updating printer software 170
- USB port 20
 - enabling 141
- using One-Click Auto Fix 88
 - Quick Fixes tab 88
- using RJ11 adapter 27

V

- vertical straight lines are not smooth 162
- viewing
 - photos from Productivity Studio 91
 - photos in the Productivity Studio 91
- voice notification
 - turning on or off 46

W

- Web page
 - printing 67
 - printing only the photos 68
- Web site
 - finding 13
- white lines appear in graphics or black areas 162
- Windows
 - setting up printer 26
- wireless network
 - adding a printer to existing ad hoc network using Windows 59
 - common home configurations 49
 - creating an ad hoc network using Windows 57
 - MAC address 51
 - networking overview 49
 - printing a network setup page 52
 - security keys 142
 - signal strength 55

- types of wireless networks 56
- wireless network connection
 - using 53
- wireless network printer does not print 143
- wireless printer is no longer working 148
- Wireless Setup Utility cannot communicate with printer during installation 151
- wireless troubleshooting
 - changing wireless settings after installation 149
 - check printer ports (Windows) 153
 - checking network name (Windows) 151
 - network printer does not show up in printer selection list during installation (Windows) 144
 - photos do not print from memory card across wireless network 177
 - ping printer (Windows) 152
 - ping wireless access point (Windows) 152
 - printer cannot connect to wireless network 150
 - run Wireless Setup Utility (Windows) 153
 - wireless network printer does not print 143
 - wireless printer is no longer working 148
 - Wireless Setup Utility cannot communicate with printer during installation 151
 - Wi-Fi indicator is not lit 145
 - Wi-Fi indicator light is blinking orange 145
 - Wi-Fi indicator light is orange 147
- Wi-Fi indicator 18
- Wi-Fi indicator is not lit 145
- Wi-Fi indicator light is blinking orange 145
- Wi-Fi indicator light is orange 147
- Wi-Fi indicator lights
 - description 48
- Work with Documents and Photos
 - scanning a photo to 106
- wrong printer attached 170