



## Interpret S400 Series User's Guide

**November 2010**

**[www.lexmark.com](http://www.lexmark.com)**

---

Machine type(s):

4443

Model(s):

201, 20E, 21n, 2En

# Contents

<b>Safety information.....</b>	<b>5</b>
<b>About your printer.....</b>	<b>6</b>
Thank you for choosing this printer!.....	6
Minimizing your printer's environmental impact.....	6
Finding information about the printer.....	7
Understanding the parts of the printer.....	9
<b>Ordering and replacing supplies.....</b>	<b>12</b>
Ordering ink cartridges.....	12
Using genuine Lexmark ink cartridges.....	12
Replacing ink cartridges.....	13
Ordering paper and other supplies.....	14
Recycling Lexmark products.....	15
<b>Using the printer control panel buttons and menus.....</b>	<b>16</b>
Using the printer control panel.....	16
Changing temporary settings into new default settings.....	18
Changing the Power Saver timeout.....	19
Saving paper and energy with Eco-Mode.....	20
Resetting to factory settings.....	20
<b>Using the printer software.....</b>	<b>21</b>
Minimum system requirements.....	21
Using the Windows printer software.....	21
Using the Macintosh printer software.....	23
Finding and installing optional software.....	25
Updating the printer software.....	25
Reinstalling the printer software.....	26
<b>Loading paper and original documents.....</b>	<b>28</b>
Loading paper.....	28
Saving paper default settings.....	31
Loading original documents on the scanner glass.....	32
Loading original documents into the ADF.....	32

<b>Printing.....</b>	<b>33</b>
Tips for printing.....	33
Printing basic documents.....	33
Printing specialty documents.....	38
Working with photos.....	41
Printing from a Bluetooth-enabled device.....	46
Managing print jobs.....	49
<b>Copying.....</b>	<b>53</b>
Tips for copying.....	53
Making copies.....	53
Copying photos.....	53
Enlarging or reducing images.....	54
Adjusting copy quality.....	54
Making a copy lighter or darker.....	54
Collating copies using the printer control panel.....	55
Repeating an image on one page.....	55
Copying multiple pages on one sheet.....	56
Making a duplex copy.....	56
Canceling copy jobs.....	57
<b>Scanning.....</b>	<b>58</b>
Tips for scanning.....	58
Scanning to a local or network computer.....	58
Scanning to a flash drive or memory card.....	59
Scanning photos into an editing application.....	59
Scanning documents into an editing application.....	61
Scanning directly to e-mail using the printer software.....	62
Scanning to a PDF.....	62
Scanning FAQ.....	63
Canceling scan jobs.....	64
<b>Faxing.....</b>	<b>65</b>
Setting up the printer to fax.....	65
Configuring the fax settings.....	76
Creating a contact list.....	78

Sending faxes.....	79
Receiving faxes.....	81
Faxing FAQ.....	82
<b>Networking.....</b>	<b>89</b>
Installing the printer on a wireless network.....	89
Advanced wireless setup.....	94
Networking FAQ.....	100
<b>Maintaining the printer.....</b>	<b>112</b>
Maintaining ink cartridges.....	112
Cleaning the exterior of the printer.....	114
Cleaning the scanner glass.....	115
<b>Troubleshooting.....</b>	<b>116</b>
Before you troubleshoot.....	116
Using the Service Center to solve printer problems.....	116
If Troubleshooting does not solve your problem.....	116
Setup troubleshooting.....	116
Jams and misfeeds troubleshooting.....	122
Print troubleshooting.....	126
Copy and scan troubleshooting.....	128
Fax troubleshooting.....	130
Memory card troubleshooting.....	137
Wireless troubleshooting.....	139
<b>Notices.....</b>	<b>157</b>
Product information.....	157
Edition notice.....	157
Power consumption.....	160
<b>Index.....</b>	<b>173</b>

# Safety information

Connect the power cord to a properly grounded electrical outlet that is near the product and easily accessible.

Do not place or use this product near water or wet locations.

Use only the power supply and power cord provided with this product or the manufacturer's authorized replacements.

Use only the telecommunications (RJ-11) cord provided with this product or a 26 AWG or larger replacement when connecting this product to the public switched telephone network.

This product is designed, tested, and approved to meet strict global safety standards with the use of specific manufacturer's components. The safety features of some parts may not always be obvious. The manufacturer is not responsible for the use of other replacement parts.

 **CAUTION—POTENTIAL INJURY:** The area behind the duplex cover has protruding ribs as part of the paper path. To avoid injury, use caution when accessing this area for clearing a paper jam.

 **CAUTION—POTENTIAL INJURY:** Do not cut, twist, bind, crush, or place heavy objects on the power cord. Do not subject the power cord to abrasion or stress. Do not pinch the power cord between objects such as furniture and walls. If any of these things happen, a risk of fire or electrical shock results. Inspect the power cord regularly for signs of such problems. Remove the power cord from the electrical outlet before inspecting it.

Refer service or repairs, other than those described in the user documentation, to a professional service person.

 **CAUTION—SHOCK HAZARD:** To avoid the risk of electric shock when cleaning the exterior of the printer, unplug the power cord from the wall outlet and disconnect all cables from the printer before proceeding.

 **CAUTION—SHOCK HAZARD:** Do not use the fax feature during a lightning storm. Do not set up this product or make any electrical or cabling connections, such as the fax feature, power cord, or telephone, during a lightning storm.

**SAVE THESE INSTRUCTIONS.**

# About your printer

## Thank you for choosing this printer!

We've worked hard to make sure it will meet your needs.

To start using your new printer right away, use the setup materials that came with the printer, and then skim the *User's Guide* to learn how to perform basic tasks. To get the most out of your printer, read the *User's Guide* carefully, and make sure you check the latest updates on our Web site.

We're committed to delivering performance and value with our printers, and we want to make sure you're satisfied. If you do encounter any problems along the way, one of our knowledgeable support representatives will be delighted to help you get back on track fast. And if you find something we could do better, please let us know. After all, you are the reason we do what we do, and your suggestions help us do it better.

## Minimizing your printer's environmental impact

We are committed to protecting the environment and are continually improving our printers to reduce their environmental impact. By selecting certain printer settings or tasks, you may be able to reduce your printer's environmental impact even further.

### Conserving energy

- **Activate Eco-Mode.** This feature sets the screen brightness to low and sets the printer to change to Power Saver mode after the printer is left idle for 10 minutes.
- **Select the lowest Power Saver timeout.** The Power Saver feature puts the printer in a minimum-power standby mode after the printer has been idle for a set amount of time (the Power Saver timeout).
- **Share your printer.** Wireless/network printers allow you to share a single printer among multiple computers, thus conserving energy and other resources.

### Conserving paper

- **Activate Eco-Mode.** On selected printer models, this feature sets the printer to automatically print on both sides of the paper (duplex) for copy and fax jobs, and for printing in Windows and Mac OS X 10.6 or later.
- **Print more than one page image on one side of the paper.** The "Pages per sheet" feature allows you to print multiple pages on one sheet. You can print up to 8 page images on one side of a sheet of paper.
- **Print on both sides of the paper.** Duplexing lets you print on both sides of the paper manually or automatically (depending on your printer model).
- **Preview print jobs before printing.** Use the preview features found in Toolbars, the Print or Print Preview dialog, or the printer display (depending on your printer model).
- **Scan and save.** To avoid printing multiple copies, you can scan documents or photographs and save them to a computer program, application, or flash drive for presentation.
- **Use recycled paper.**

## Conserving ink

- **Use Quick Print or Draft Mode.** These modes can be used to print documents using less ink than normal and are ideal for printing documents that are mostly text.
- **Use High Yield cartridges.** Inks in High-Yield cartridges allow you to print more pages with fewer cartridges.
- **Clean the printhead.** Before replacing and recycling your ink cartridges, try using the “Clean Printhead” and “Deep Clean Printhead” features. These features clean the printhead nozzles to improve the quality of your prints.

## Recycling

- **Return ink cartridges for reuse or recycling through the Lexmark Cartridge Collection Program.** To return an ink cartridge, go to [www.lexmark.com/recycle](http://www.lexmark.com/recycle). Follow the instructions to request a postage-paid bag.
- **Recycle the product packaging.**
- **Recycle your old printer instead of throwing it away.**
- **Recycle paper from discarded print jobs.**
- **Use recycled paper.**

To read the Lexmark Environmental Sustainability Report, see [www.lexmark.com/environment](http://www.lexmark.com/environment).

## Finding information about the printer

### Publications

What are you looking for?	Find it here
<p>Initial setup instructions:</p> <ul style="list-style-type: none"> <li>• Connecting the printer</li> <li>• Installing the printer software</li> </ul>	<p>Setup documentation</p> <p>The setup documentation came with the printer and is also available on the Lexmark Web site at <a href="http://support.lexmark.com">http://support.lexmark.com</a>.</p> 

What are you looking for?	Find it here
<p>Additional setup and instructions for using the printer:</p> <ul style="list-style-type: none"> <li>• Selecting and storing paper and specialty media</li> <li>• Loading paper</li> <li>• Performing printing, copying, scanning, and faxing tasks, depending on your printer model</li> <li>• Configuring printer settings</li> <li>• Viewing and printing documents and photos</li> <li>• Setting up and using printer software</li> <li>• Setting up and configuring the printer on a network, depending on your printer model</li> <li>• Caring for and maintaining the printer</li> <li>• Troubleshooting and solving problems</li> </ul>	<p><i>User's Guide</i></p> <p>The <i>User's Guide</i> is available on the installation software CD.</p> <div data-bbox="1068 331 1268 527" data-label="Image"> </div> <p>For updates, check our Web site at <a href="http://support.lexmark.com">http://support.lexmark.com</a>.</p>
<p>Help using the printer software</p>	<p>Windows or Mac Help</p> <p>Open a printer software program or application, and then click <b>Help</b>.</p> <p>Click  to view context-sensitive information.</p> <p><b>Notes:</b></p> <ul style="list-style-type: none"> <li>• The Help installs automatically with the printer software.</li> <li>• The printer software is located in the printer Program folder or on the desktop, depending on your operating system.</li> </ul>
<p>The latest supplemental information, updates, and online technical support:</p> <ul style="list-style-type: none"> <li>• Troubleshooting hints and tips</li> <li>• Frequently asked questions</li> <li>• Documentation</li> <li>• Driver downloads</li> <li>• Live chat support</li> <li>• E-mail support</li> </ul>	<p>Lexmark Support Web site— <a href="http://support.lexmark.com">http://support.lexmark.com</a></p> <p><b>Note:</b> Select your region, and then select your product to view the appropriate support site.</p> <p>Record the following information (located on the store receipt and the back of the printer), and have it ready when you contact support so that they may serve you faster:</p> <ul style="list-style-type: none"> <li>• Machine Type number</li> <li>• Serial number</li> <li>• Date purchased</li> <li>• Store where purchased</li> </ul>
<p>Telephone support</p>	<p>In the US, call us at: 1-800-332-4120 Monday–Friday (8:00 AM–11:00 PM ET), Saturday and Sunday (11:00 AM–8:00 PM ET)</p> <p>Support telephone numbers and hours of operation for your region or country can be found on the Support Web site (<a href="http://support.lexmark.com">http://support.lexmark.com</a>) or on the printed warranty that came with your printer.</p>



What are you looking for?	Find it here
Warranty information	<p>Warranty information varies by country or region:</p> <ul style="list-style-type: none"> <li>• <b>In the US</b>—See the Statement of Limited Warranty included with this printer, or at <a href="http://support.lexmark.com">http://support.lexmark.com</a>.</li> <li>• <b>Rest of the world</b>—See the printed warranty that came with your printer.</li> </ul>

## Understanding the parts of the printer

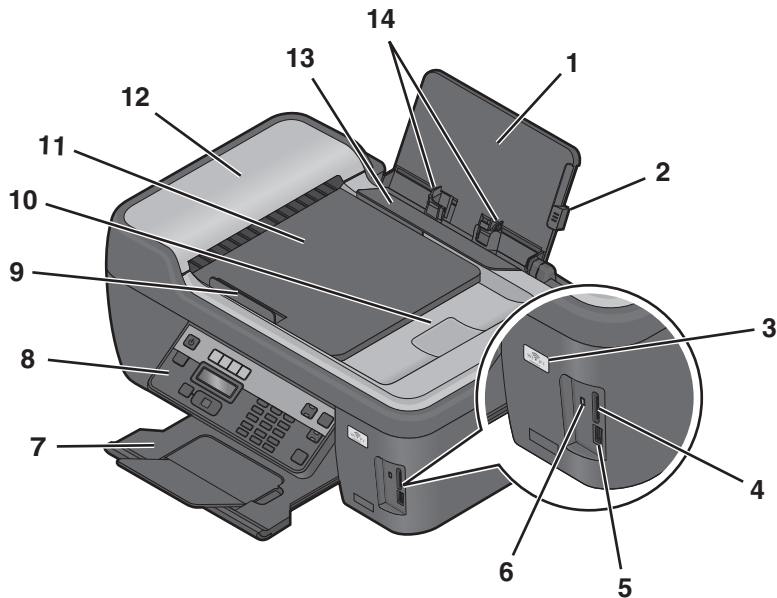

	Use the	To
1	Paper support	Load paper.
2	Paper guide adjustment lever	Adjust the paper guides.
3	Wi-Fi indicator	Check wireless status.
4	Memory card slots	Insert a memory card.
5	PictBridge and USB port	Connect a PictBridge-enabled digital camera, USB Bluetooth adapter or a flash drive to the printer.
6	Card reader light	Check card reader status. The light blinks to indicate that a memory card is being accessed.
7	Paper exit tray	Hold paper as it exits.
8	Printer control panel	Operate the printer.
9	Automatic Document Feeder (ADF) paper guide	<p>Keep paper straight when feeding it into the ADF.</p> <p><b>Note:</b> Adjust the paper guide on the ADF tray to the width of the original document.</p>
10	ADF output tray	Hold documents as they exit from the ADF.

	Use the	To
11	ADF tray	Load original documents in the ADF. Recommended for scanning, copying, or faxing multiple-page documents. <b>Note:</b> Do not load postcards, photos, small items, or thin media (such as magazine clippings) into the ADF. Place these items on the scanner glass.
12	ADF	Scan, copy, or fax multiple-page letter-, legal-, and A4-size documents.
13	Paper feed guard	Prevent items from falling into the paper slot.
14	Paper guides	Keep paper straight when feeding.

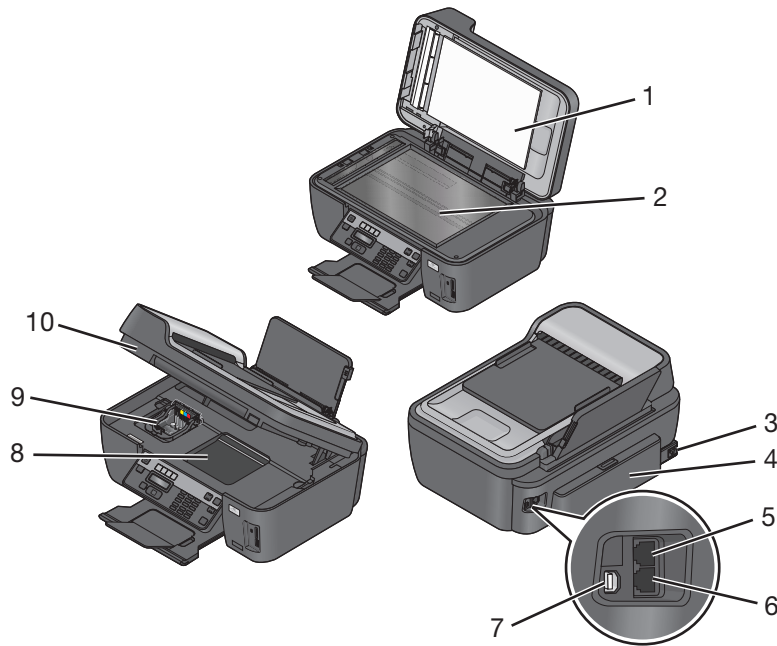

	Use the	To
1	Scanner lid	Access the scanner glass.
2	Scanner glass	Scan and copy photos and documents.
3	Power supply with port	Connect the printer to a properly grounded electrical outlet that is near and easily accessible.
4	Duplex unit	<ul style="list-style-type: none"> <li>Print on both sides of a sheet of paper.</li> <li>Remove paper jams.</li> </ul> <b>Note:</b> The duplex unit is available only on select models.
5	EXT Port 	Connect additional devices (telephone or answering machine) to the printer and the telephone line. Use this port if you do not have a dedicated fax line for the printer, and if this connection method is supported in your country or region. <b>Note:</b> Remove the plug to access the port.

	Use the	To
6	LINE Port 	Connect the printer to an active telephone line (through a standard wall jack, DSL filter, or VoIP adapter) to send and receive faxes.
7	USB port	Connect the printer to a computer using a USB cable. <b>Warning—Potential Damage:</b> Do not touch the USB port except when plugging in or removing a USB cable or installation cable.
8	Printhead access	Install the printhead. <b>Note:</b> The carrier moves to the printhead access area when no printhead is installed in the printer.
9	Ink cartridge access	Install, replace, or remove ink cartridges.
10	Scanner unit	<ul style="list-style-type: none"> <li>• Access the ink cartridges and printhead.</li> <li>• Remove paper jams.</li> </ul>

# Ordering and replacing supplies

## Ordering ink cartridges

Page yields available at [www.lexmark.com/pageyields](http://www.lexmark.com/pageyields). For best results, use only Lexmark ink cartridges.

Lexmark S400 Series models (except Lexmark S408)

Item	Return Program Cartridge <sup>1</sup>	Regular cartridge <sup>2</sup>
Black cartridge	100	100A
High yield black cartridge	100XL	100XLA
Yellow color cartridge	100	100A
High yield yellow color cartridge	100XL	100XLA
Cyan color cartridge	100	100A
High yield cyan color cartridge	100XL	100XLA
Magenta color cartridge	100	100A
High yield magenta color cartridge	100XL	100XLA

<sup>1</sup> Licensed for a single use only. After use, return this cartridge to Lexmark for remanufacturing, refilling, or recycling.  
<sup>2</sup> Available only on the Lexmark Web site at [www.lexmark.com](http://www.lexmark.com).

Lexmark S408 models

Item	Return Program Cartridge <sup>1</sup>	Regular cartridge <sup>2</sup>
Black cartridge	108	108A
High yield black cartridge	108XL	108XLA
Yellow color cartridge	108	108A
High yield yellow color cartridge	108XL	108XLA
Cyan color cartridge	108	108A
High yield cyan color cartridge	108XL	108XLA
Magenta color cartridge	108	108A
High yield magenta color cartridge	108XL	108XLA

<sup>1</sup> Licensed for a single use only. After use, return this cartridge to Lexmark for remanufacturing, refilling, or recycling.  
<sup>2</sup> Available only on the Lexmark Web site at [www.lexmark.com](http://www.lexmark.com).

## Using genuine Lexmark ink cartridges

Lexmark printers, ink cartridges, and photo paper are designed to perform together for superior print quality, and our inks are formulated to work with your printer and help extend the life of your product. We recommend that you use only genuine Lexmark ink cartridges.

Lexmark's warranty does not cover damage caused by non-Lexmark ink or ink cartridges.

## Replacing ink cartridges

Make sure you have a new ink cartridge or cartridges before you begin. You must install new cartridges immediately after removing the old ones, or the ink remaining in the printhead nozzles may dry out.

- 1 Turn on your printer.
- 2 Open the printer.

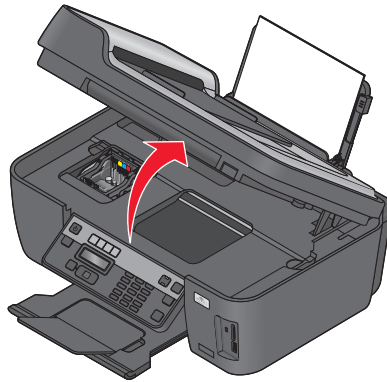

**Note:** The printhead moves to the cartridge installation position.

- 3 Press the release tab, and then remove the used ink cartridge or cartridges.

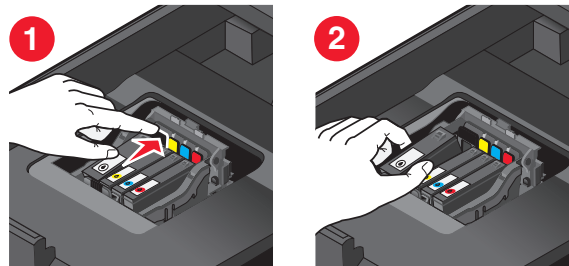

- 4 Remove the ink cartridge from the pack, and then remove the protective cap from the ink cartridge.  
If your ink cartridge comes with a muzzle cap, then remove the cap.

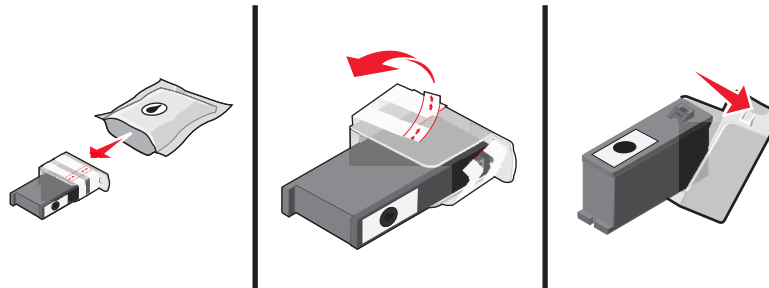

If your ink cartridge comes with a twist cap, then twist and remove the cap.

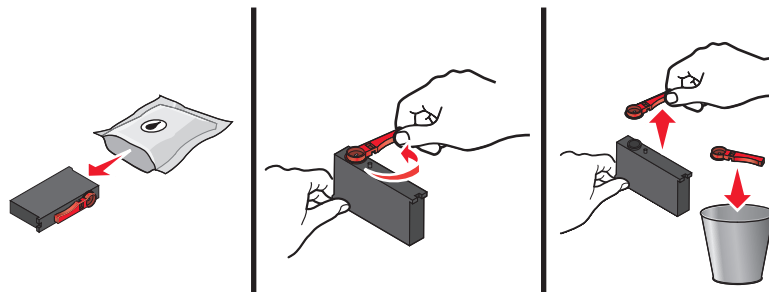

5 Install each ink cartridge. Use two hands to install the black cartridge.



**Note:** Install the new ink cartridges immediately after removing the protective cap to avoid exposing the ink to air.

6 Close the printer.

## Ordering paper and other supplies

To order supplies or to locate a dealer near you, visit our Web site at [www.lexmark.com](http://www.lexmark.com).

Item	Part Number
USB cable	1021294
For more information, go to <a href="http://www.lexmark.com">www.lexmark.com</a> .	

Paper	Paper size
Lexmark Photo Paper	<ul style="list-style-type: none"><li>• Letter</li><li>• A4</li><li>• 4 x 6 in.</li><li>• L</li></ul>
<b>Notes:</b> <ul style="list-style-type: none"><li>• Availability may vary by country or region.</li><li>• For best results when printing photos or other high-quality images, use Lexmark Photo Paper or Lexmark PerfectFinish™ Photo Paper.</li><li>• For more information, go to <a href="http://www.lexmark.com">www.lexmark.com</a></li></ul>	

Paper	Paper size
Lexmark PerfectFinish Photo Paper	<ul style="list-style-type: none"> <li>• Letter</li> <li>• A4</li> <li>• 4 x 6 in.</li> <li>• L</li> </ul>
<p><b>Notes:</b></p> <ul style="list-style-type: none"> <li>• Availability may vary by country or region.</li> <li>• For best results when printing photos or other high-quality images, use Lexmark Photo Paper or Lexmark PerfectFinish™ Photo Paper.</li> <li>• For more information, go to <a href="http://www.lexmark.com">www.lexmark.com</a></li> </ul>	

## Recycling Lexmark products

To return Lexmark products for recycling:





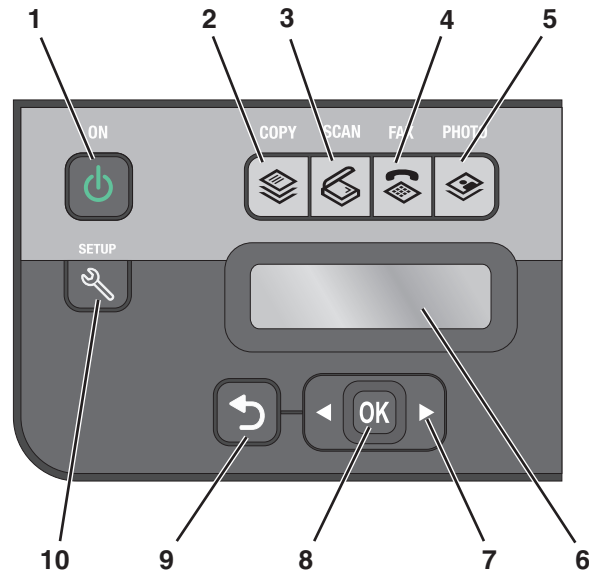

- 1 Visit our Web site at [www.lexmark.com/recycle](http://www.lexmark.com/recycle).
- 2 Find the product type you want to recycle, and then select your country or region from the list.
- 3 Follow the instructions on the computer screen.

**Note:** Printer supplies and hardware not listed in a Lexmark collection program may be recycled through your local recycling center. Contact your local recycling center to determine the items they accept.



# Using the printer control panel buttons and menus

## Using the printer control panel





	Use the	To
1	Power button 	<ul style="list-style-type: none"> <li>Turn the printer on and off.</li> <li>Switch to Power Saver mode.</li> </ul> <p><b>Note:</b> When the printer is on, press  to switch to Power Saver mode. Press and hold  for three seconds to turn off the printer.</p>
2	Copy button 	Access the copy menu and make copies.
3	Scan button 	Access the scan menu and scan documents.
4	Fax button 	Access the fax menu and send faxes.
5	Photo button 	Access the photo menu and print photos.
6	Display <b>Note:</b> The display is turned off in Power Saver mode.	View: <ul style="list-style-type: none"> <li>Printer status</li> <li>Messages</li> <li>Menus</li> </ul>
7	Arrow buttons	Choose a menu or submenu item that appears on the display.

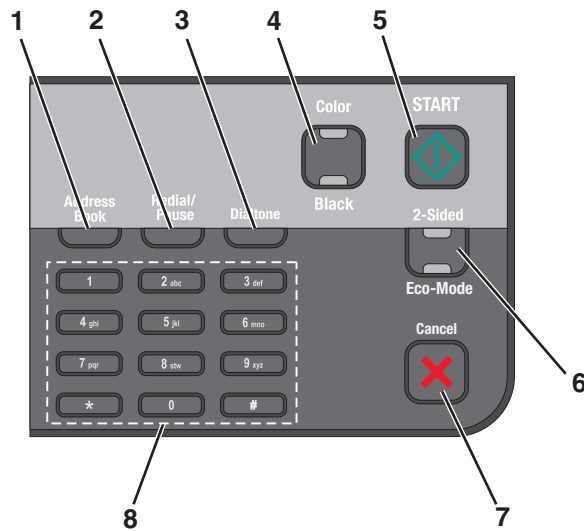

	Use the	To
8	Select button 	<ul style="list-style-type: none"> <li>Select menu options.</li> <li>Save settings.</li> <li>Feed or eject paper. Press and hold for three seconds to feed or eject paper from the printer.</li> </ul>
9	Back button 	<ul style="list-style-type: none"> <li>Return to the previous screen.</li> <li>Exit from one menu level to a higher one.</li> </ul>
10	Setup button 	<p>Access the setup menu and change printer settings.</p> <p><b>Note:</b> The Copy, Scan, Fax, and Photo button lights are off when this button is selected.</p>



	Use the	To
1	<b>Address Book</b>	Access fax numbers from a saved list of numbers.
2	<b>Redial/Pause</b>	<p>In Fax mode:</p> <ul style="list-style-type: none"> <li>Insert a three-second pause in a fax number to wait for an outside line or get through an automated answering system. Enter a pause only when you have already begun entering the number.</li> <li>Display the last number dialed. Press the left or right arrow button to view the last five numbers dialed.</li> </ul>
3	<b>Dialtone</b>	Dial the telephone number manually using the keypad before sending the fax.
4	<b>Color/Black</b>	Switch to color mode or black-and-white mode.
5	Start button 	Start a print, scan, fax, or copy job, depending on which mode is selected.

	Use the	To
6	2-Sided/Eco-Mode	<p>Activate 2-Sided to:</p> <ul style="list-style-type: none"> <li>• Print on both sides of the paper (duplex).</li> </ul> <p>Activate Eco-Mode to:</p> <ul style="list-style-type: none"> <li>• Print on both sides of the paper (duplex).</li> <li>• Change to Power Saver mode after the printer is left idle for ten minutes.</li> <li>• Set screen brightness to low.</li> </ul> <p><b>Note:</b> 2-Sided/Eco-Mode is available only on select models.</p>
7	Cancel button 	<ul style="list-style-type: none"> <li>• Cancel a print, copy, scan, or fax job in progress.</li> <li>• Exit from a menu level of the Copy, Scan, Fax, Photo, or File Print menu to the top level of a menu.</li> <li>• Exit from a menu level of the Setup menu to the top level of the previous mode.</li> <li>• Clear current settings or error messages, and return to default settings.</li> </ul>
8	Keypad	<p>In Copy mode or Photo mode: enter the number of copies or prints you want to make.</p> <p>In Fax mode:</p> <ul style="list-style-type: none"> <li>• Enter fax numbers.</li> <li>• Navigate an automated answering system.</li> <li>• Select letters when creating a Speed Dial list.</li> <li>• Type numbers to enter or edit the date and time shown on the display.</li> </ul>



## Changing temporary settings into new default settings

The following menus revert to default settings after two minutes of inactivity or after the printer is turned off:

Copy menu	<ul style="list-style-type: none"> <li>• Copies</li> <li>• Quality</li> <li>• Lighter/Darker</li> <li>• Resize</li> <li>• Original Size</li> <li>• Pages per Sheet</li> <li>• Copies per Sheet</li> <li>• Content Type</li> </ul>
Scan menu	<ul style="list-style-type: none"> <li>• Quality</li> <li>• Original Size</li> </ul>
Fax menu (selected models only)	<ul style="list-style-type: none"> <li>• Lighter/Darker</li> <li>• Quality</li> </ul>



Photo menu	<p>The following Photo options will not time out after two minutes of inactivity or after you turn off the printer, but they will return to the factory default settings when a memory card or flash drive is removed.</p> <ul style="list-style-type: none"> <li>• Photo Effects</li> <li>• Photo Size</li> <li>• Layout</li> <li>• Quality</li> </ul>
------------	---

## To change the temporary settings into new default settings

- 1 From the printer control panel, press .
- 2 Press the arrow buttons to scroll to **Defaults**, and then press **OK**.
- 3 Press the arrow buttons to scroll to **Set Defaults**, and then press **OK**.  
**Use Current** appears on the display.
- 4 Press **OK** again to select **Use Current**.
- 5 Press  until you exit Setup, or press another mode button.



## To disable the settings timeout feature

You can disable the settings timeout feature if you do not want the printer to revert to the default settings after two minutes of inactivity or after the printer is turned off.

- 1 From the printer control panel, press .
- 2 Press the arrow buttons to scroll to **Device Setup**, and then press **OK**.
- 3 Press the arrow buttons to scroll to **Clear Settings Timeout**, and then press **OK**.
- 4 Press the arrow buttons to scroll to **Never**, and then press **OK**.
- 5 Press  until you exit Setup, or press another mode button.

## Changing the Power Saver timeout

The Power Saver timeout is the time it takes for the printer to switch to Power Saver mode when the printer is left idle. The Power Saver feature optimizes energy efficiency by reducing the printer power consumption (as much as 28 percent on some printer models) compared to the default printer settings. To save the most energy, select the lowest Power Saver timeout.

- 1 From the printer control panel, press .
- 2 Press the arrow buttons to scroll to **Device Setup**, and then press **OK**.
- 3 Press the arrow buttons to scroll to **Power Saver**, and then press **OK**.
- 4 Press the arrow buttons to select a Power Saver timeout, and then press **OK**.
- 5 Press  until you exit Setup, or press another mode button.

# Saving paper and energy with Eco-Mode

The Eco-Mode feature significantly cuts paper usage, reduces paper waste, optimizes energy efficiency, and saves money.

**Note:** If you are using Eco-Mode, then the Eco-Mode settings override any changes you may make to individual settings that are part of Eco-Mode.

When Eco-Mode is enabled, the printer automatically switches to the following settings:

- The printer display is dimmed.
- The printer changes to Power Saver mode after ten minutes.
- The printer prints on both sides of the paper (duplex) for copy and fax jobs, and for printing in Windows and Mac OS X 10.6 or later (selected models only).

To enable Eco-Mode, press the **2-Sided/Eco-Mode** button until the light near “Eco-Mode” comes on.







## Resetting to factory settings

Resetting to factory default settings will delete all the printer settings you have previously selected.

### Using the printer control panel menus

- 1 From the printer control panel, press .
- 2 Press the arrow buttons to scroll to **Defaults**, and then press **OK**.
- 3 Press the arrow buttons to scroll to **Set Defaults**, and then press **OK**.
- 4 Press the arrow buttons to scroll to **Use Factory**, and then press **OK**.
- 5 When prompted to set the initial settings of your printer, make your selections using the printer control panel buttons.  
**Initial Setup Complete** appears on the display.

### Using a button combination (if you cannot read the current language)

- 1 Turn off the printer.  
**Note:** If you have set the Power Saver timeout in the Setup menu, then press and hold  for three seconds to turn off the printer.
- 2 From the printer control panel, press and hold  and , and then press and release  to turn the printer on.  
**Note:** Do not release  and  until **Language** appears on the display, indicating that the printer has been reset.
- 3 When prompted to set the initial settings of your printer, make your selections using the printer control panel buttons.  
**Initial Setup Complete** appears on the display.

# Using the printer software

## Minimum system requirements

The printer software requires up to 500MB of free disk space.

## Supported operating systems

- Microsoft Windows 7 (Web only)\*
- Microsoft Windows Vista (SP1)
- Microsoft Windows XP (SP3)
- Microsoft Windows 2000 (SP4 or later)
- Macintosh PowerPC OS X version 10.3.9 to 10.6
- Macintosh Intel OS X version 10.4.4 to 10.6
- Linux Ubuntu 8.10 and 8.04 LTS (Web only)\*
- Linux openSUSE 11.1 and 11.0 (Web only)\*
- Linux Fedora 10 (Web only)\*

\* The printer driver for this operating system is available only at <http://support.lexmark.com>.

## Using the Windows printer software

### Software installed during printer installation

When you set up the printer using the installation software CD, all the necessary software was installed. You may have chosen to install some additional programs. The following table provides an overview of various software programs and what they can help you do.

If you did not install these additional programs during initial installation, then reinsert the installation software CD, run the installation software, and then select **Install Additional Software** from the Software Already Installed screen.

## Printer software

Use the	To
Lexmark™ Printer Home (referred to as Printer Home)	<ul style="list-style-type: none"> <li>• Launch applications or programs.</li> <li>• Access the Fax Solutions software.</li> <li>• Scan or e-mail a photo or document.</li> <li>• Edit scanned documents.</li> <li>• Scan documents to PDF.</li> <li>• Adjust settings for the printer.</li> <li>• Order supplies.</li> <li>• Maintain ink cartridges.</li> <li>• Print a test page.</li> <li>• Register the printer.</li> <li>• Contact technical support.</li> </ul>
Lexmark Fast Pics (referred to as Fast Pics)	Manage, edit, transfer, and print photos and documents.
Lexmark Toolbar (referred to as Toolbar)	<ul style="list-style-type: none"> <li>• Print black or text-only Web pages to save ink.</li> <li>• Schedule automatic printing of Web pages.</li> <li>• Access Picnik and edit photos online.</li> <li>• Print, scan, or convert local files from Windows.</li> </ul>
Lexmark Tools for Office (referred to as Tools for Office)	Access your favorite settings in Microsoft Office 2007.
Lexmark Fax Solutions (referred to as Fax Solutions)	<ul style="list-style-type: none"> <li>• Send a fax.</li> <li>• Receive a fax in three-in-one printers.</li> <li>• Add, edit, or delete contacts in the built-in phone book.</li> <li>• Access the Lexmark Fax Setup Utility in four-in-one printers. Use the Fax Setup Utility to set the Speed Dial and Group Dial numbers, set Ringing and Answering, and print fax history and status reports.</li> </ul>
Abbyy Sprint OCR	Scan a document and produce text that you can edit with a word-processing program.
Lexmark Wireless Setup Utility (referred to as Wireless Setup Utility)	<ul style="list-style-type: none"> <li>• Set up the wireless printer on a wireless network.</li> <li>• Change the wireless settings of the printer.</li> </ul> <p><b>Note:</b> This program is installed automatically with the printer software if the printer has wireless capability.</p>
Lexmark Service Center (referred to as Service Center)	<ul style="list-style-type: none"> <li>• Troubleshoot the printer.</li> <li>• Access the printer maintenance functions.</li> <li>• Contact technical support.</li> </ul> <p><b>Notes:</b></p> <ul style="list-style-type: none"> <li>• This program is installed automatically with the printer software.</li> <li>• You may be prompted to install this program from the Web, depending on your printer model.</li> </ul>

Use the	To
Printing Preferences	<p>When you select <b>File → Print</b> with a document open and then click <b>Properties</b>, a Printing Preferences dialog appears. The dialog lets you select options for the print job, such as the following:</p> <ul style="list-style-type: none"> <li>• Select the number of copies to print.</li> <li>• Print two-sided copies.</li> <li>• Select the paper type.</li> <li>• Add a watermark.</li> <li>• Enhance images.</li> <li>• Save settings.</li> </ul> <p><b>Note:</b> Printing Preferences is installed automatically with the printer software.</p>

**Note:** Your printer may not come with some of these programs or some of the functions of these programs, depending on the features of the printer that you purchased.

## Using the Macintosh printer software

### Software installed during printer installation

Applications are installed along with the printer software during installation.

- 1 From the Applications folder in the Finder, or from the Finder desktop, double-click the printer folder.
- 2 Double-click the application that you want to use.

Use the	To
Print dialog	<p>Adjust the print settings and schedule print jobs.</p> <p><b>Note:</b> With a document or photo open, choose <b>File &gt; Print</b> to access the Print dialog.</p>
Printer Services dialog (not available in Mac OS X version 10.5 or later)	<ul style="list-style-type: none"> <li>• Access the printer utility.</li> <li>• Troubleshoot.</li> <li>• Order ink or supplies.</li> <li>• Contact Lexmark.</li> <li>• Check the printer software version installed on the computer.</li> </ul>
Scan Center (in Mac OS X version 10.6) or Lexmark All-In-One Center (in Mac OS X version 10.5 or earlier) (referred to as All-In-One Center)	<ul style="list-style-type: none"> <li>• Scan photos and documents.</li> <li>• Customize settings for scan jobs.</li> </ul>
Printer Settings (in Mac OS X version 10.6) or Lexmark AIO Setup Utility (in Mac OS X version 10.5 or earlier) (referred to as AIO Setup Utility)	<ul style="list-style-type: none"> <li>• Customize settings for fax jobs.</li> <li>• Create and edit the Contacts list.</li> </ul>

Use the	To
Network Card Reader (in Mac OS X version 10.6) or Lexmark Network Card Reader (in Mac OS X version 10.5 or earlier) (referred to as Network Card Reader)	<ul style="list-style-type: none"> <li>• View the contents of a memory device inserted into a network printer.</li> <li>• Transfer photos and PDF documents from a memory device to the computer over a network.</li> </ul>
Lexmark Printer Utility (not available in Mac OS X version 10.6) (referred to as Printer Utility)	<ul style="list-style-type: none"> <li>• Get help with cartridge installation.</li> <li>• Print a test page.</li> <li>• Print an alignment page.</li> <li>• Clean the printhead nozzles.</li> <li>• Order ink or supplies.</li> <li>• Register the printer.</li> <li>• Contact technical support.</li> </ul>
Wireless Setup Assistant (in Mac OS X version 10.6) or Lexmark Wireless Setup Assistant (in Mac OS X version 10.5 or earlier) (referred to as Wireless Setup Assistant)	Set up the printer on a wireless network. <b>Note:</b> This application is automatically installed with the printer software if the printer has wireless capability.
Uninstaller	Remove the printer software from your computer.

**Note:** Your printer may not come with these applications, depending on the features of the printer that you purchased.

## Web Links

Web Links are links to predefined Web pages.

### In Mac OS X version 10.6

- 1 From the Finder, navigate to:  
**Applications** > select your printer folder > **Web Links**
- 2 Double-click the Web Link that you want to visit.

### In Mac OS X version 10.5 or earlier

- 1 From the Finder desktop, double-click the printer folder.
- 2 Double-click the **Printer Utility** icon.
- 3 From the Web Links tab, select the link you want to visit.

Use	To
Customer Support	Contact technical support.
Lexmark Software Updates	Download and install the latest printer software.
Lexmark Online	Visit the Lexmark Web site.
Order Supplies Online	Order ink or supplies.
Printer Registration	Register your printer.



Use	To
Visit Lexmark SmartSolutions	<ul style="list-style-type: none"> <li>• Visit the SmartSolutions Web site.</li> <li>• Choose your custom solutions.</li> </ul>

**Note:** Your printer may not come with these Web Links, depending on the features of the printer that you purchased.

## Finding and installing optional software

### For Windows users

- 1 Click  or **Start**.
- 2 Click **All Programs** or **Programs**, and then select the printer program folder from the list.
- 3 Navigate to:  
**Printer Home** > select your printer > **Support** tab > **On-line support**
- 4 From the Web site, select your printer and then download the driver.
- 5 Install additional or optional software.

### For Macintosh users

#### In Mac OS X version 10.6

- 1 From the Finder, navigate to:  
**Applications** > select your printer folder > **Web Links** > **Lexmark Software Updates**
- 2 From the Web site, select your printer and then download the driver.
- 3 Install additional or optional software.

#### In Mac OS X version 10.5 or earlier

- 1 From the Finder desktop, double-click the printer folder.
- 2 Double-click the **Printer Utility** icon.
- 3 From the Web Links tab, click **Customer Support**.
- 4 From the Web site, select your printer and download the driver.
- 5 Install additional or optional software.

## Updating the printer software

### Checking for software updates

#### For Windows users

- 1 Click  or **Start**.
- 2 Click **All Programs** or **Programs**, and then select the printer program folder from the list.

- 3 Navigate to:  
**Printer Home** > select your printer > **Support** tab > **Check for Software Updates**
- 4 Follow the instructions on the computer screen.

## For Macintosh users

### In Mac OS X version 10.6

- 1 From the Finder, navigate to:  
**Applications** > select your printer folder > **Web Links** > **Lexmark Software Updates**
- 2 From the Web site, select your printer and then download the driver.

### In Mac OS X version 10.5 or earlier

- 1 From the Finder desktop, double-click the printer folder.
- 2 Double-click the **Printer Utility** icon.
- 3 From the Web Links tab, click **Customer Support**.
- 4 From the Web site, select your printer and then download the driver.

## Enabling automatic software updates (Windows only)

- 1 With a document open, click **File** > **Print**.
- 2 Click **Properties**, **Preferences**, **Options**, or **Setup**.
- 3 Navigate to:  
**Advanced** tab > **More Options** > **Allow automatic updates from the web for my software** > **OK**

## Reinstalling the printer software

When you set up the printer using the installation software CD, all the necessary software was installed. If you encountered problems while installing, or if your printer does not appear in the printers folder or as a printer option when you send a print job, then try removing and reinstalling the printer software.

## Uninstalling the printer software

### For Windows users

- 1 Click  or **Start**.
- 2 Click **All Programs** or **Programs**, and then select the printer program folder from the list.
- 3 Select the uninstall option.
- 4 Follow the instructions on the computer screen to remove the software.
- 5 Once the uninstall process is complete, restart your computer.

## For Macintosh users

- 1 From the Applications folder in the Finder, or from the Finder desktop, double-click the printer folder.
- 2 Double-click the **Uninstaller** icon.
- 3 Follow the instructions on the computer screen to remove the software.

## Installing the printer software

**Note:** If you installed the printer software on this computer before but need to reinstall the software, then uninstall the current software first.

### For Windows users

- 1 Close all open software programs.
- 2 Insert the installation software CD.  
If the Welcome screen does not appear after a minute, then launch the CD manually:
  - a Click , or click **Start** and then click **Run**.
  - b In the Start Search or Run box, type **D:\setup.exe**, where **D** is the letter of your CD or DVD drive.
- 3 Follow the instructions on the Welcome screen.

### For Macintosh users

- 1 Close all open software applications.
- 2 Insert the installation software CD.  
If the installation dialog does not appear after a minute, then click the CD icon on the desktop.
- 3 Double-click **Install**.
- 4 Follow the instructions on the installation dialog.

## Using the Internet

- 1 Go to the Lexmark Web site at **www.lexmark.com**.
- 2 Navigate to:  
**Downloads > Driver Finder > select your printer > select your operating system**
- 3 Download the driver and install the printer software.

**Note:** Updated printer software may be available at **http://support.lexmark.com**.

# Loading paper and original documents

## Loading paper

- 1 Fan the paper.

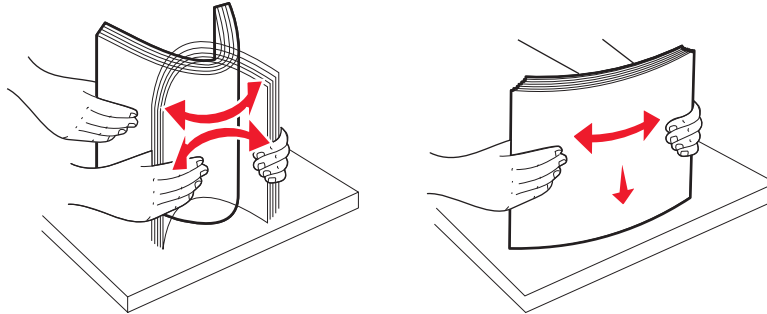

- 2 Center the paper on the paper support.
- 3 Adjust the paper guides so they rest against the edges of the paper.

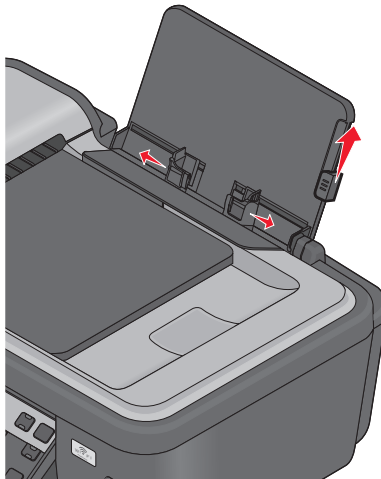

**Note:** Do not force paper into the printer. The paper should be flat against the paper support, and the edges should be flush against both paper guides.

- 4 From the printer control panel, select or confirm your paper settings.

## Paper and specialty media guidelines

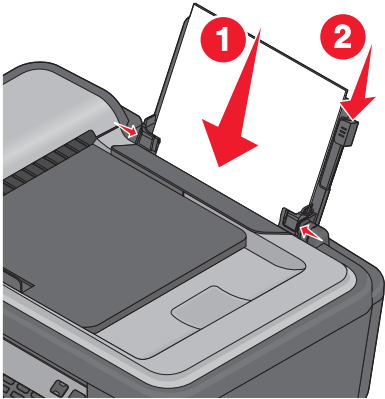
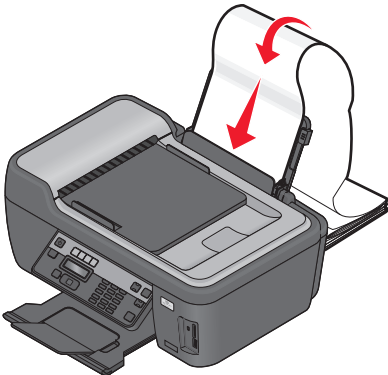
Load up to:	Make sure that:
<p>100 sheets of plain paper</p> 	<ul style="list-style-type: none"><li>• The paper guides rest against the edges of the paper.</li><li>• You load letterhead paper with the print side faceup and the top of the letterhead going into the printer first.</li></ul>
<p>25 sheets of heavyweight matte paper</p>	<ul style="list-style-type: none"><li>• The print side of the paper is faceup.</li><li>• The paper guides rest against the edges of the paper.</li><li>• You select <b>Automatic, Normal, or Photo</b> print quality.</li></ul> <p><b>Note:</b> Draft mode is available but is not recommended for use with expensive paper such as heavyweight matte, labels, photo cards and glossy paper.</p>
<p>20 sheets of banner paper</p> 	<ul style="list-style-type: none"><li>• You remove all paper from the paper support before inserting banner paper.</li><li>• You use banner paper designed for inkjet printers.</li><li>• You place a stack of banner paper on or behind the printer, and feed in the first sheet.</li><li>• The paper guides rest against the edges of the paper.</li><li>• You select <b>A4 Banner</b> or <b>Letter Banner</b> paper size.</li></ul>

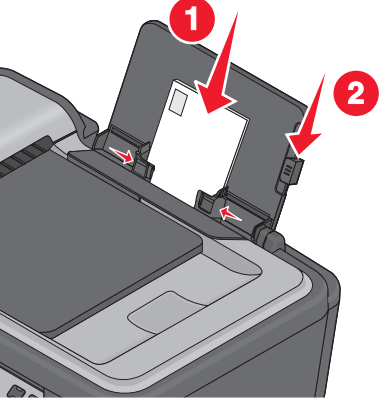
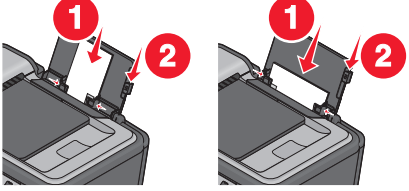
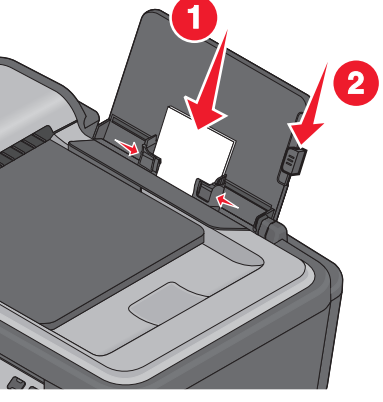

Load up to:	Make sure that:
<p>10 envelopes</p> 	<ul style="list-style-type: none"> <li>The print side of the envelope is faceup.</li> <li>The paper guides rest against the edges of the envelopes.</li> <li>You print the envelopes with <b>Landscape</b> orientation.</li> </ul> <p><b>Note:</b> If you are mailing within Japan, then the envelope can be printed in Portrait orientation with the stamp in the lower right corner or in Landscape orientation with the stamp in the lower left corner. If you are mailing internationally, then print in Landscape orientation with the stamp in the upper left corner.</p>  <ul style="list-style-type: none"> <li>You select the correct envelope size. Select the next biggest size if the exact envelope size is not listed, and set the left and right margins so your envelope is correctly positioned.</li> </ul>
<p>25 sheets of labels</p>	<ul style="list-style-type: none"> <li>The print side of the label is faceup.</li> <li>The paper guides rest against the edges of the paper.</li> <li>You select <b>Automatic, Normal, or Photo</b> print quality.</li> </ul> <p><b>Note:</b> Draft mode is available but is not recommended for use with expensive paper such as heavyweight matte, labels, photo cards and glossy paper.</p>
<p>25 greeting cards, index cards, postcards, or photo cards</p> 	<ul style="list-style-type: none"> <li>The print side of the card is faceup.</li> <li>The paper guides rest against the edges of the cards.</li> <li>You select <b>Automatic, Normal, or Photo</b> print quality.</li> </ul> <p><b>Note:</b> Draft mode is available but is not recommended for use with expensive paper such as heavyweight matte, labels, photo cards and glossy paper.</p>
<p>25 sheets of photo/glossy paper</p>	<ul style="list-style-type: none"> <li>The print side of the paper is faceup.</li> <li>The paper guides rest against the edges of the paper.</li> <li>You select <b>Automatic, Normal, or Photo</b> print quality.</li> </ul> <p><b>Note:</b> Draft mode is available but is not recommended for use with expensive paper such as heavyweight matte, labels, photo cards and glossy paper.</p>

Load up to:	Make sure that:
10 iron-on transfers	<ul style="list-style-type: none"> <li>• You follow the loading instructions on the iron-on transfer packaging.</li> <li>• The print side of the transfer is faceup.</li> <li>• The paper guides rest against the edges of the transfer.</li> <li>• You select <b>Automatic</b>, <b>Normal</b>, or <b>Photo</b> print quality.</li> </ul>
50 transparencies	<ul style="list-style-type: none"> <li>• The rough side of the transparencies is faceup.</li> <li>• The paper guides rest against the edges of the transparencies.</li> </ul>

## Saving paper default settings

You can set the default paper size, paper type, and photo print size for the documents and photos that you print.

**Note:** These default settings apply only to print, copy, and scan jobs that you initiate from the printer.

- 1 From the printer control panel, press .
- 2 Choose the default settings:
  - If you want to set the default paper size:
    - a Press **OK** to select **Paper Setup**.
    - b Press the arrow buttons to scroll to **Paper Size**, and then press **OK**.
    - c Press the arrow buttons to select the default paper size for the printer, and then press **OK**.
  - If you want to set the default paper type:
    - a Press **OK** to select **Paper Setup**.
    - b Press the arrow buttons to scroll to **Paper Type**, and then press **OK**.
    - c Press the arrow buttons to select the default paper type for the printer, and then press **OK**.
  - If you want to set the default photo print size:
    - a Press the arrow buttons to scroll to **Defaults**, and then press **OK**.
    - b Press **OK** to select **Photo Print Size**.
    - c Press the arrow buttons to select the default photo print size for the printer, and then press **OK**.
- 3 Press  until you exit Setup, or press another mode button.

## Loading original documents on the scanner glass

- 1 Open the scanner lid and place the document facedown on the scanner glass.
- 2 Close the scanner lid.

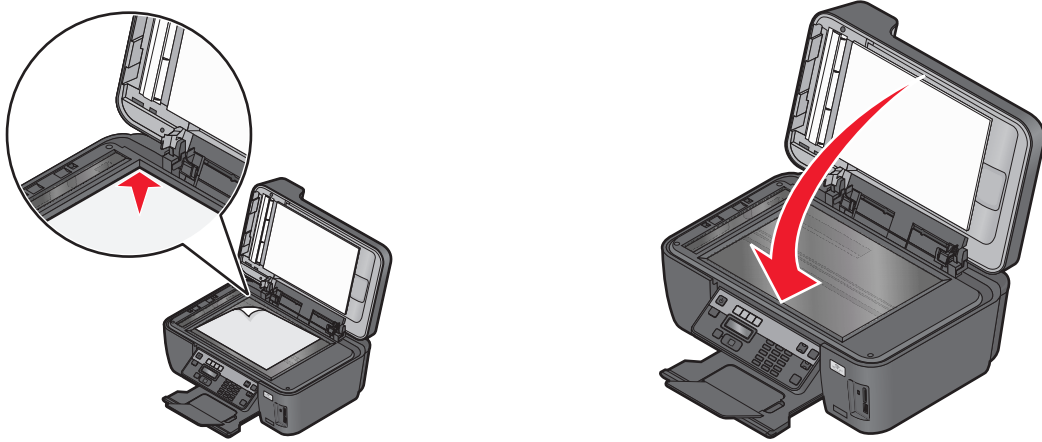

## Loading original documents into the ADF

You can load up to 35 sheets of an original document into the ADF for scanning, copying, and faxing. You can load A4-, letter-, or legal-size paper into the ADF.

- 1 Adjust the paper guide on the ADF tray to the width of the original document.
- 2 Load the original document faceup and top edge first into the ADF until you hear a *beep*.

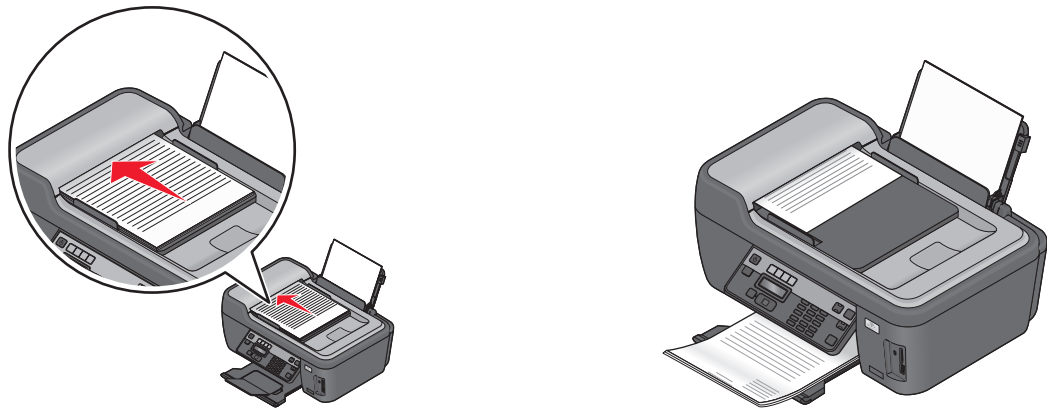



# Printing

## Tips for printing

- Use the appropriate paper for your print job.
- Select a higher print quality for better prints.
- Make sure there is enough ink in the ink cartridges.
- Remove each sheet as it is printed when printing photos or when working with specialty media.
- Select the borderless setting when printing photos.

## Printing basic documents

### Printing a document

#### For Windows users

- 1 With a document open, click **File > Print**.
- 2 Click **Properties, Preferences, Options, or Setup**.
- 3 Select the print quality, the number of copies to print, the type of paper to use, and how the pages should print.
- 4 Click **OK** to close any printer software dialogs.
- 5 Click **OK** or **Print**.

#### For Macintosh users

- 1 With a document open, choose **File > Page Setup**.
- 2 From the Page Setup dialog, set the printer, paper size, and orientation.
- 3 Click **OK**.
- 4 From the menu bar, choose **File > Print**.
- 5 From the Printer pop-up menu, choose your printer.
- 6 From the print options menu, choose the print quality, the number of copies to print, the type of paper to use, and how the pages should print.
- 7 Click **Print**.

## Collating printed copies

When printing multiple copies of a document, you can choose to print each copy as a set (collated) or to print the copies as groups of pages (not collated).

### Collated



### Not collated



### Notes:

- The collate option is available only when you are printing multiple copies.
- To prevent smudging when printing photos, remove each photo as it exits the printer, and then let it dry before stacking.

### For Windows users

- 1 With a document open, click **File > Print**.
- 2 Click **Properties, Preferences, Options, or Setup**.
- 3 Navigate to:  
**Print Setup** tab > Copies area
- 4 Enter the number of copies that you want to print, and then select **Collate Copies**.
- 5 Click **OK** to close any printer software dialogs.
- 6 Click **OK** or **Print**.

### For Macintosh users

- 1 With a document open, choose **File > Page Setup**.
- 2 From the Page Setup dialog, set the printer, paper size, and orientation.
- 3 Click **OK**.
- 4 From the menu bar, choose **File > Print**.
- 5 From the Printer pop-up menu, choose your printer.
- 6 From the Copies area, enter the number of copies that you want to print, and then choose **Collated**.
- 7 Click **Print**.

## Printing pages in reverse order

### For Windows users

- 1 With a document open, click **File > Print**.
- 2 Click **Properties, Preferences, Options, or Setup**.

**3** From the Copies area of the Print Setup tab, select a page order:

- To print the last page first, select **Print Last Page First**.
- To print the first page first, clear the **Print Last Page First** check box.

**Note:** If two-sided printing is enabled, then you cannot print the last page first. To change the print order, you must first disable two-sided printing.

**4** Click **OK** to close any printer software dialogs.

**5** Click **OK** or **Print**.

### For Macintosh users

**1** With a document open, choose **File > Page Setup**.

**2** From the Page Setup dialog, set the printer, paper size, and orientation.

**3** Click **OK**.

**4** From the menu bar, choose **File > Print**.

**5** From the Printer pop-up menu, choose your printer.

**6** From the print options pop-up menu, choose **Paper Handling**.

**7** From the Page Order menu, choose a page order:

- To print the last page first, choose **Reverse** or **Reverse page order**.
- To print the first page first, choose **Normal** or clear the **Reverse page order** option.

**8** Click **Print**.

## Printing multiple pages on one sheet

### For Windows users

**1** With a document open, click **File > Print**.

**2** Click **Properties, Preferences, Options, or Setup**.

**3** Navigate to:

**Advanced** tab > Layout list > select **Pages per sheet**

**4** Select the number of page images to print on each page.

**5** Adjust other settings as needed.

**6** Click **OK** to close any printer software dialogs.

**7** Click **OK** or **Print**.

### For Macintosh users

**1** With a document open, choose **File > Page Setup**.

**2** From the Page Setup dialog, set the printer, paper size, and orientation.

**3** Click **OK**.

- 4 From the menu bar, choose **File > Print**.
- 5 From the Printer pop-up menu, choose your printer.
- 6 From the print options pop-up menu, choose **Layout**.
- 7 From the Pages per Sheet pop-up menu, choose the number of page images to print on each page.
- 8 Adjust other settings as needed.
- 9 Click **Print**.

## Printing on both sides of the paper (duplexing) manually

### For Windows users

- 1 With a document open, click **File → Print**.
- 2 Click **Properties, Preferences, Options, or Setup**.
- 3 Click the **Advanced** tab.
- 4 From the 2-Sided Printing section, select **Manual**.  
**Note:** The Print Instruction Page to Assist in Reloading item is selected automatically.
- 5 Click **OK**. The printer prints the odd-numbered pages and the instruction sheet.
- 6 Flip and reload the paper, following the directions on the instruction sheet to complete the print job.

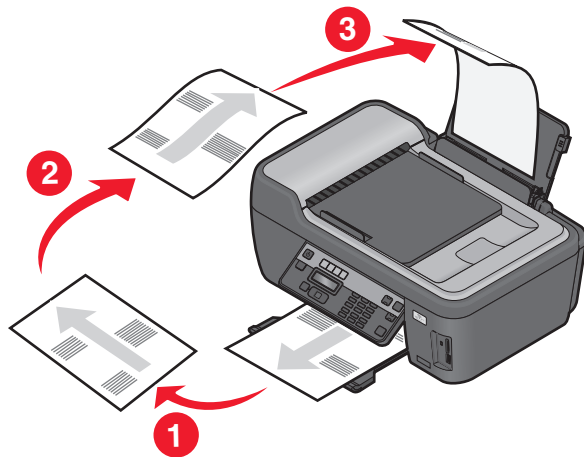

**Note:** To return to single-sided printing, return to the Advanced tab. From the 2-Sided Printing section, select **Off** from the drop-down menu.

### For Macintosh users

- 1 With a document open, choose **File > Print**.
- 2 From the print options pop-up menu, choose **Paper Handling**.
- 3 From the Print or “Pages to print” pop-up menu, select to print the odd-numbered pages.
- 4 If you are printing multiple pages, then from the Page Order menu, select **Reverse**.

5 After printing the first set of pages, flip and reload the paper.

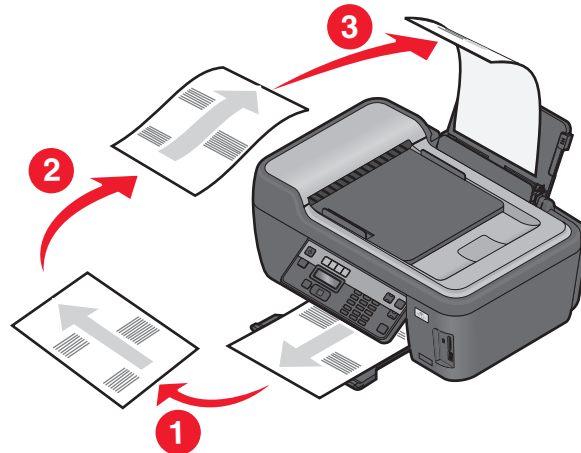

6 Repeat steps 1 and 2.

7 From the Print or “Pages to print” pop-up menu, select to print the even-numbered pages.

8 Click **Print**.

## Printing documents from a memory card or flash drive (Windows only)

To enable the File Print function:

- The printer must be connected to a computer through a USB cable or through a network.
- The printer and the computer must be on.
- The memory card or flash drive must contain document files that are supported by the printer. For more information, see “Supported memory cards and file types” on page 42.
- The computer must contain applications that support the file types in the memory device.

1 Insert a memory card or flash drive.

When the printer detects the memory device, **Memory Card Detected** or **Storage Device Detected** appears on the display.

2 If only document files are stored on the memory device, then the printer automatically switches to File Print mode.

If document files and image files are stored on the memory device, then press **OK** to select **Documents**.

3 Select and print the document:

### If the printer is using a USB connection

- a Press the arrow buttons to select the file name of the document that you want to print or the folder where the document is saved in the memory device.
- b Press **OK**, and then press **▶** to start printing the document.

### If the printer is using a Wireless connection (selected models only)

- a Press the arrow buttons to select the file name of the document that you want to print.
- b Press **OK**, and then wait for the printer to connect to the network computer or to finish searching the network for available computers.

- c When prompted, press the arrow buttons to select the name of the network computer, and then press **OK** to start printing the document.

**Notes:**

- You may be prompted to enter a PIN if the computer requires it. Enter the PIN using the keypad.
- To assign a computer name and a PIN to the computer, see the Help for the printer software associated with your operating system.

## Printing specialty documents

### Printing envelopes

#### For Windows users

- 1 With a document open, click **File > Print**.
- 2 Click **Properties, Preferences, Options, or Setup**.
- 3 Navigate to:  
**Print Setup** tab > Paper Type list > select **Plain Paper**
- 4 Navigate to:  
Paper Size list > select your envelope size  
If no size matches the envelope size, then set a custom size.
- 5 Select an orientation.
- 6 Click **OK** to close any printer software dialogs.
- 7 Click **OK** or **Print**.

#### For Macintosh users

- 1 With a document open, choose **File > Page Setup**.
- 2 From the “Format for” pop-up menu, choose your printer.
- 3 From the Paper Size pop-up menu, choose your envelope size.  
If no size matches the envelope size, then set a custom size.
- 4 Select an orientation, and then click **OK**.
- 5 From the menu bar, choose **File > Print**.
- 6 From the Printer pop-up menu, choose your printer.
- 7 Click **Print**.

**Notes:**

- Most envelopes use landscape orientation.
- Make sure the same orientation is also selected in the application.

## Printing labels

### For Windows users

- 1 With a document open, click **File > Print**.
- 2 Click **Properties, Preferences, Options, or Setup**.
- 3 Navigate to:  
**Print Setup** tab > Paper Type list > select your paper type
- 4 Navigate to:  
Paper Size list > select your paper size  
If no paper size matches the label sheet size, then set a custom size.
- 5 Click **OK** to close any printer software dialogs.
- 6 Click **OK** or **Print**.

### For Macintosh users

- 1 With a document open, choose **File > Page Setup**.
- 2 From the “Format for” pop-up menu, choose your printer.
- 3 From the Paper Size pop-up menu, choose your paper size.  
If no paper size matches the label sheet size, then set a custom size.
- 4 Select an orientation, and then click **OK**.
- 5 From the menu bar, choose **File > Print**.
- 6 From the Printer pop-up menu, choose your printer.
- 7 From the print options pop-up menu, choose **Print Settings** or **Quality & Media**.
- 8 From the Paper Type pop-up menu, choose **Card Stock**.
- 9 From the Print Quality menu, choose a print quality other than Quick Print or Draft.
- 10 Click **Print**.

### Tips on loading label sheets

- Make sure the top of the label sheet feeds into the printer first.
- Make sure the adhesive on the labels does not extend to within 1 mm of the edge of the label sheet.
- Make sure the paper guide or paper guides rest against the edges of the label sheet.
- Use full label sheets. Partial sheets (with areas exposed by missing labels) may cause labels to peel off during printing, resulting in a paper jam.

## Printing on custom-size paper

### For Windows users

- 1 With a document open, click **File > Print**.
- 2 Click **Properties, Preferences, Options, or Setup**.
- 3 Navigate to:  
**Print Setup** tab > Paper Size list > select **Custom Size**
- 4 Adjust the settings as needed to create a custom size, and then click **OK**.
- 5 Click **OK** to close any printer software dialogs.
- 6 Click **OK** or **Print**.

### For Macintosh users

- 1 With a document open, choose **File > Page Setup**.
- 2 From the “Format for” pop-up menu, choose your printer.
- 3 From the Paper Size pop-up menu, choose **Manage Custom Sizes**.
- 4 Adjust the settings as needed to create a custom size, and then click **OK**.
- 5 From the Paper Size pop-up menu, choose the custom size you created, and then click **OK**.
- 6 From the menu bar, choose **File > Print**.
- 7 From the printer pop-up menu, choose your printer.
- 8 Click **Print**.



# Working with photos

## Using a memory card or flash drive with the printer

Memory cards and flash drives are storage devices frequently used with cameras and computers. You can remove the memory card from the camera or the flash drive from the computer and insert it directly into the printer.

- 1 Insert a memory card into the card slot or a flash drive into the USB port.

### Inserting a memory card

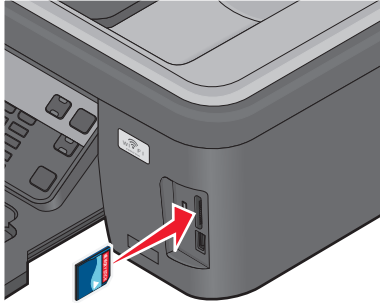

#### Notes:

- Insert the card with the brand name label facing right.
- Make sure any arrows on the card point toward the printer.
- If necessary, connect the memory card to the adapter that came with it.
- Make sure that the memory card inserted is supported by the printer. For more information, see “Supported memory cards and file types” on page 42.

### Inserting a flash drive

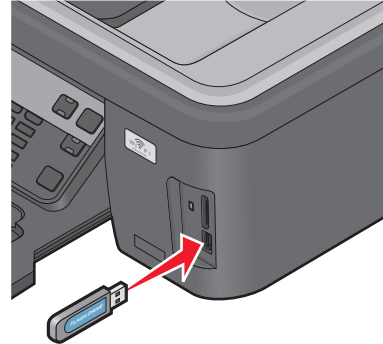

#### Notes:

- The flash drive uses the same port that is used for a PictBridge camera cable.
- An adapter may be necessary if your flash drive does not fit directly into the port.



**Warning—Potential Damage:** Do not touch any cables, any network adapter, any connector, the memory device, or the printer in the areas shown while actively printing, reading, or writing from the memory device. A loss of data can occur.

- 2 Look for **Memory Card Detected** or **Storage Device Detected** on the display.

#### Notes:

- If the printer does not recognize the memory device, then remove and reinsert it.
- If a flash drive or a digital camera set to mass storage mode is inserted into the USB port while a memory card is in the card slot, then a message appears on the display prompting you to choose which memory device to use.

## Supported memory cards and file types

Memory Card	File Type
<ul style="list-style-type: none"><li>• Secure Digital (SD)</li><li>• Secure Digital High Capacity (SDHC)</li><li>• Micro Secure Digital (with adapter) (Micro SD)</li><li>• Mini Secure Digital (with adapter) (Mini SD)</li><li>• MultiMedia Card (MMC)</li><li>• Reduced Size MultiMedia Card (with adapter) (RS-MMC)</li><li>• MultiMedia Card mobile (with adapter) (MMCmobile)</li><li>• Memory Stick</li><li>• Memory Stick PRO</li><li>• Memory Stick Duo (with adapter)</li><li>• Memory Stick PRO Duo (with adapter)</li><li>• xD-Picture Card</li><li>• xD-Picture Card (Type H)</li><li>• xD-Picture Card (Type M)</li></ul>	<p>Documents:</p> <ul style="list-style-type: none"><li>• .doc (Microsoft Word)</li><li>• .xls (Microsoft Excel)</li><li>• .ppt (Microsoft PowerPoint)</li><li>• .pdf (Adobe Portable Document Format)</li><li>• .rtf (Rich Text Format)</li><li>• .docx (Microsoft Word Open Document Format)</li><li>• .xlsx (Microsoft Excel Open Document Format)</li><li>• .pptx (Microsoft PowerPoint Open Document Format)</li><li>• .wpd (WordPerfect)</li></ul> <p>Images:</p> <ul style="list-style-type: none"><li>• JPEG</li><li>• TIFF</li></ul>

## Printing photos using the printer control panel

- 1 Load photo paper.
- 2 From the printer control panel, press .
- 3 Insert a memory card, flash drive, or digital camera set to mass storage mode.  
If document files and image files are stored in the memory device, then press the arrow buttons to select **Photos**, and then press **OK**.
- 4 Press the arrow buttons to scroll to **Easy Photo** or **Print Photos**, and then press **OK**.

### Notes:

- Select **Easy Photo** if you want to print photos quickly.
- Select **Print Photos** if you want to customize the photos before printing them.

- 5 Press the arrow buttons to select a photo printing option, and then press **OK**.

**Note:** You can choose to print the most recent photo, print all the photos, print photos that fall within a date range, print photos by selecting the photo numbers on a proof sheet, or print pre-selected photos from a digital camera using Digital Print Order Format (DPOF). The DPOF option appears only when there is a valid DPOF file in your memory device.

- 6 Adjust the print settings:
  - If you are in the Easy Photo menu, then press the arrow buttons to select the paper size and photo size. Press **OK** each time you make a selection.
  - If you are in the Print Photos menu, then press the arrow buttons to select the photo size, paper size, paper type, layout, photo effects, and quality of the photos, and to adjust the brightness and color effects of the photos. Press **OK** each time you make a selection.

7 Press the **Color/Black** button to set a color or black-and-white print.  
When you select color or black-only printing, the light near your choice comes on.

8 Press .

**Note:** For best results, allow the prints to dry at least 24 hours before stacking, displaying, or storing.

## Printing photos from a memory device using the printer software

1 Load photo paper with the glossy or printable side faceup. (If you are not sure which side is the printable side, then see the instructions that came with the paper.)

2 From the printer control panel, press .

3 Insert a memory card, flash drive, or digital camera set to mass storage mode.

If document files and image files are stored on the memory device, then press  to select **Photos**.

4 Transfer or print the photos:

### If the printer is using a USB connection

- **For Windows users**

Fast Pics launches automatically when you insert the memory device. Follow the instructions on the computer screen to transfer the photos to the computer or to print.

- **For Macintosh users**

If you have set an application to launch when a memory device is connected to the computer, then the application automatically launches. Follow the instructions on the computer screen to transfer the photos to the computer or to print.

### If the printer is using a Wireless connection (selected models only)

a Press the arrow buttons to scroll to **Select Computer**, and then press .

b Press the arrow buttons to select the network computer where you want to save the photos, and then press .

c Transfer or print the photos:

- **For Windows users**

Fast Pics launches automatically when you insert the memory device. Follow the instructions on the computer screen to transfer the photos to the computer or to print.

- **For Macintosh users**

Select **Yes** to view images from the memory device. The Network Card Reader launches on the computer. Follow the instructions on the computer screen to transfer the photos to the computer or to print.

## Printing photos from a PictBridge-enabled digital camera

PictBridge is a technology available in most digital cameras that lets you print directly from your digital camera without using a computer.

- 1 Insert one end of the USB cable into the camera.

**Note:** Use only the USB cable that came with the camera.

- 2 Insert the other end of the cable into the PictBridge port on the front of the printer.

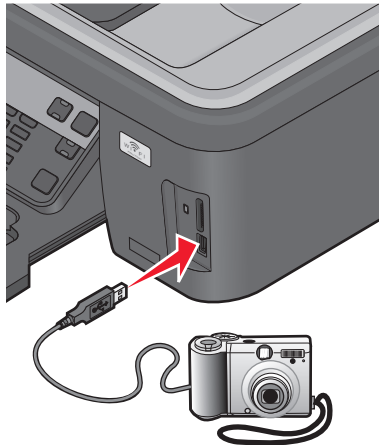

### Notes:

- Make sure that the PictBridge-enabled digital camera is set to the correct USB mode. If the camera USB selection is incorrect, then the camera is detected as a flash drive, or an error message will be displayed on the printer control panel. For more information, see the camera documentation.
- The printer reads only one memory device at a time.







**Warning—Potential Damage:** Do not touch the USB cable, any network adapter, any connector, the memory device, or the printer in the areas shown while actively printing, reading, or writing from the memory device. A loss of data can occur.

- 3 If the PictBridge connection is successful, then the following message appears on the display: **PictBridge Camera detected. Press OK to change settings.**
- 4 Press **OK** to access the PictBridge menu.
- 5 Press the arrow buttons to select the paper size, paper type, photo size, and layout of the photos that you want to print. Press **OK** each time you make a selection.
- 6 See the documentation for your camera to begin printing.

**Note:** If you insert the camera while the printer is performing another job, then wait for the job to finish before printing from the camera.

## Printing photos from a memory device using the proof sheet

- 1 Load letter- or A4-size plain paper.
  - 2 From the printer control panel, press .
  - 3 Insert a memory card or flash drive.  
If document files and image files are stored in the memory device, then press the arrow buttons to select **Photos**, and then press **OK**.
  - 4 Press the arrow buttons to scroll to **Proof Sheet**, and then press **OK**.
  - 5 Press the arrow buttons to select an option to print a proof sheet.  
You can print a proof sheet:
    - For all photos on the memory device.
    - For the 20 most recent photos, if there are 20 or more photos on the memory device.
    - By date, if the photos on the card were taken on different dates. If you choose this option, then select the date.
  - 6 Press .
  - The proof sheet prints.
  - 7 Follow the instructions on the proof sheet to select which photos to print, the number of copies per photo, red-eye reduction, page layout, print options, and paper size.  
**Note:** When making selections, make sure to fill in the circles completely.
  - 8 When **Scan Proof Sheet** appears on the display, press **OK**, and then load the proof sheet facedown on the scanner glass.  
**Note:** If **Scan Proof Sheet** does not appear on the display, then press the arrow buttons until it appears on the display.
  - 9 Press .
  - The printer scans the proof sheet.
  - 10 Load photo paper with the glossy or printable side faceup. (If you are not sure which side is the printable side, then see the instructions that came with the paper.)  
**Note:** Make sure that the paper matches the size that you selected on the proof sheet.
  - 11 Press the **Color/Black** button to set a color or black-and-white print.  
When you select color or black-only printing, the light near your choice comes on.
  - 12 Press  to print the photos.
- Note:** For best results, allow the prints to dry at least 24 hours before stacking, displaying, or storing.

## Printing photos from a digital camera using DPOF

If your camera supports Digital Print Order Format (DPOF), then you can specify which photos to print, how many of each, and the print settings while the memory card is still in the camera. The printer recognizes these settings when you insert the memory card into the printer or connect the camera to the printer.

**Note:** If you specify a photo size while the memory card is still in the camera, then make sure that the size of the paper loaded in the printer is not smaller than the size you specify in the DPOF selection.

**1** Load photo paper with the glossy or printable side faceup. (If you are not sure which side is the printable side, then see the instructions that came with the paper.)

**2** From the printer control panel, press .

**3** Insert a memory card.

**Memory Card Detected** appears on the display.

**4** Press the arrow buttons to scroll to **Print Photos**, and then press **OK**.

**5** Press the arrow buttons to scroll to **Print DPOF**, and then press  to print the photos.

**Note:** This option appears only if a DPOF file is detected in the memory card.

**Note:** For best results, allow the prints to dry at least 24 hours before stacking, displaying, or storing.

## Printing from a Bluetooth-enabled device

- This printer is compliant with Bluetooth Specification 2.0. It supports the following profiles: Object Push Profile (OPP) and Serial Port Profile (SPP). Check with your Bluetooth-enabled device manufacturers (cellular phone or PDA) to determine their hardware compatibility and interoperability. It is recommended that you use the latest firmware on your Bluetooth-enabled device.
- To print Microsoft documents from your Windows Mobile/Pocket PC PDA, additional third-party software and drivers are required. For more information about the required software, see the documentation for your PDA.

## Setting up a connection between your printer and a Bluetooth-enabled device

**Note:** The printer does not support printing files from your computer using a Bluetooth connection.

You need to set up a connection between a Bluetooth-enabled device and your printer if you are sending a print job from the Bluetooth device for the first time. You will need to repeat the setup if:

- You reset the printer to its factory default settings.
- You change the Bluetooth security level or the Bluetooth pass key.
- The Bluetooth-enabled device you are using requires users to set up a Bluetooth connection on every print job. For more information, see the documentation for your Bluetooth device.
- The name of the Bluetooth device you are using is automatically deleted from the Bluetooth device list.

When the Bluetooth security level is set to High, the printer saves a list of up to eight Bluetooth devices that have previously set up a connection with the printer. When the printer detects more than eight devices, the least recently used device is removed from the list. You need to repeat the setup of the deleted device to be able to send a print job to the printer.

**Note:** You need to set up a connection for each Bluetooth device that you use to send a print job to the printer.

To set up a connection between the printer and a Bluetooth-enabled device:

- 1 Insert a USB Bluetooth adapter into the USB port located on the front of the printer.

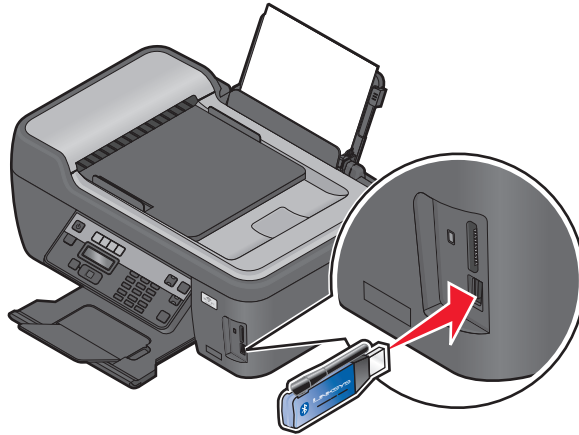

**Bluetooth Dongle Connected** appears on the display.

**Note:** A Bluetooth adapter is not included with the printer.

- 2 From the printer control panel, press .
- 3 Press the arrow buttons to scroll to **Bluetooth Setup**, and then press **OK**.
- 4 Press the arrow buttons to scroll to **Discovery**, and then press **OK**.
- 5 Make sure Discovery is set to On. If necessary, press the arrow buttons to scroll to **On**, and then press **OK**.  
The printer is now ready to accept a connection from a Bluetooth-enabled device.
- 6 Configure the Bluetooth-enabled device to set up a connection to the printer. For more information, see the documentation for your Bluetooth device.

**Note:** If the Bluetooth Security Level on the printer is set to High, then you must enter a pass key.

## Setting the Bluetooth security level

- 1 Insert a Bluetooth USB adapter into the USB port.

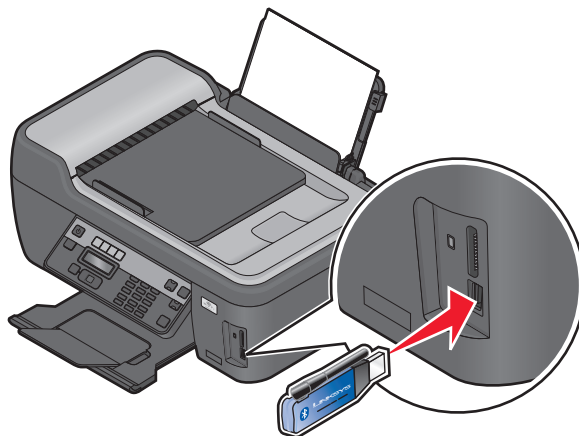

**Bluetooth Dongle Connected** appears on the display.

**Note:** A Bluetooth adapter is not included with the printer.

- 2 From the printer control panel, press .
- 3 Press the arrow buttons to scroll to **Bluetooth Setup**, and then press button **OK**.
- 4 Press the arrow buttons to scroll to **Security Level**, and then press **OK**.
- 5 Press the arrow buttons to select the security level, and then press **OK**.
  - Select **Low** to allow Bluetooth devices to connect and send print jobs to your printer without requiring users to enter a pass key.
  - Select **High** to require users to enter a four-digit numeric pass key on the Bluetooth device before connecting and sending print jobs to the printer.
- 6 The Bluetooth Pass Key menu appears on the display if you set the security level to High. Use the keypad to enter your four-digit pass key, and then press **OK**.

## Printing from a Bluetooth-enabled device

**Note:** The printer does not support printing files from your computer using a Bluetooth connection.

- 1 Insert a USB Bluetooth adapter into the USB port.

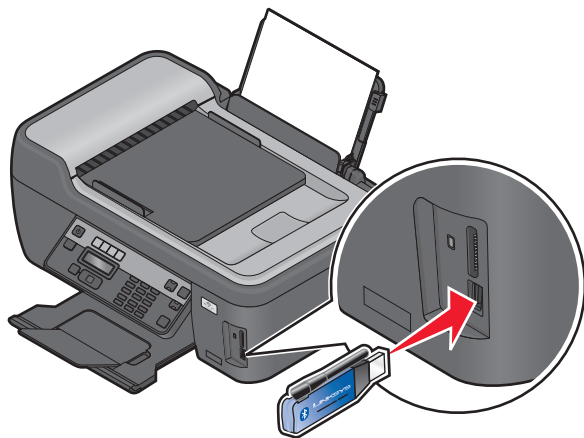

**Bluetooth Dongle Connected** appears on the display.

**Warning—Potential Damage:** Do not touch cables, any network adapter, any connector, the USB Bluetooth adapter, or the printer in the areas shown while actively printing, reading, or writing from a Bluetooth-enabled device. A loss of data can occur.

### Notes:

- A Bluetooth adapter is not included with the printer.
  - Your printer automatically switches to Bluetooth mode when you insert a USB Bluetooth adapter.
- 2 Make sure the printer is set up to receive Bluetooth connections. For more information, see “Setting up a connection between your printer and a Bluetooth-enabled device” on page 46.



- 3 Set up the Bluetooth device to print to the printer. For more information, see the documentation for your Bluetooth device.
- 4 See the documentation for your Bluetooth device to begin printing.  
**Note:** If the Bluetooth Security Level on the printer is set to High, you must enter a pass key.

## Managing print jobs

### Setting your printer as the default printer

Your printer should be selected automatically from the Print dialog when you send a print job. If you have to manually select your printer, then it is not the default printer.

To set the default printer:

#### For Windows users

- 1 Click , or click **Start** and then click **Run**.
- 2 In the Start Search or Run box, type **control printers**.
- 3 Press **Enter**, or click **OK**.  
The printers folder opens.
- 4 Right-click the printer, and then select **Set as Default Printer**.

#### For Macintosh users

- 1 From the Apple menu, navigate to:  
**System Preferences > Print & Fax**
- 2 Select the printer from the Default Printer pop-up menu, or select the printer and click **Make Default**.

### Changing the printing mode

To conserve ink, you can change the default printing mode for all print jobs to Draft or Quick Print. It uses less ink and is ideal for printing text-only documents. If you need to print photos or other high-quality documents, then you can select a different mode from the Print dialog before sending the print job.

To change the default print mode:

#### For Windows users

- 1 Click , or click **Start** and then click **Run**.
- 2 In the Start Search or Run box, type **control printers**.
- 3 Press **Enter**, or click **OK**.  
The printer folder opens.
- 4 Right-click the printer, and then select **Printing Preferences**.
- 5 Select **Quick Print** as the printing mode.

## For Macintosh users

- 1 With a document open, choose **File > Print**.
- 2 From the printer pop-up menu, choose the printer.
- 3 From the print options pop-up menu, choose **Print Settings** or **Quality & Media**, depending on your operating system.
- 4 From the Print Quality pop-up menu, choose **Draft** or **Quick Print** as the printing mode.
- 5 From the Presets pop-up menu, choose **Save as**, and then type a name for your setting configuration.  
You must choose this configuration name from the Presets pop-up menu for each print job.

## Changing the printing mode for a single print job

### For Windows users

- 1 With a document open, click **File > Print**.
- 2 Click **Properties, Preferences, Options, or Setup**.
- 3 Select **Automatic, Quick Print, Normal, or Best**.

**Note:** Printing in Draft or Quick Print mode uses less ink and is ideal for printing text documents.

### For Macintosh users

- 1 With a document open, choose **File > Print**.
- 2 From the printer pop-up menu, choose the printer.
- 3 From the print options pop-up menu, choose **Print Settings** or **Quality & Media**, depending on your operating system.
- 4 From the Print Quality pop-up menu, choose **Automatic, Draft or Quick Print, Normal, Photo or Best**.

**Note:** Printing using Quick Print uses less ink and is ideal for printing text documents.

## Pausing print jobs

### For Windows users

- 1 Click , or click **Start** and then click **Run**.
- 2 In the Start Search or Run box, type **control printers**.
- 3 Press **Enter**, or click **OK**.  
The printer folder opens.
- 4 Right-click the printer, and then select **Open** or **See what's printing**.
- 5 Pause the print job:
  - If you want to pause a particular print job, then right-click the document name, and then select **Pause**.
  - If you want to pause all print jobs in the queue, then click **Printer**, and then select **Pause Printing**.

## For Macintosh users

- 1 Click the printer icon on the Dock.

The print queue dialog appears.

- 2 Pause the print job:

- If you want to pause a particular print job, then choose the document name, and then click **Hold**.
- If you want to pause all print jobs in the queue, then click **Pause Printer** or **Stop Jobs**, depending on your operating system.

## Resuming print jobs

### For Windows users

- 1 Click , or click **Start** and then click **Run**.

- 2 In the Start Search or Run box, type **control printers**.

- 3 Press **Enter**, or click **OK**.

The printers folder opens.

- 4 Right-click the printer, and then select **Open** or **See what's printing**.

- 5 Resume the print job:

- If you want to resume a particular print job, then right-click the document name, and then select **Resume** or **Restart**.
- If you want to resume all print jobs in the queue, then click **Printer**, and then clear the selection for Pause Printing.

### For Macintosh users

- 1 From the Apple menu, navigate to:

**System Preferences > Print & Fax > select your printer**

- 2 Click **Open Print Queue** or **Set Up Printers**.

The print queue dialog appears.

- 3 Resume the print job:

- If you want to resume a particular print job, then choose the document name, and then click **Resume**.
- If you want to resume all print jobs in the queue, then click **Resume Printer** or **Start Jobs**.

## Canceling print jobs

To cancel a print job from the printer control panel, press . To cancel a print job from the computer, do the following:

### For Windows users

- 1 Click , or click **Start** and then click **Run**.

- 2 In the Start Search or Run box, type **control printers**.

**3** Press **Enter**, or click **OK**.

The printer folder opens.

**4** Right-click the printer, and then select **Open** or **See what's printing**.

**5** Cancel the print job:

- If you want to cancel a particular print job, then right-click the document name, and then select **Cancel**.
- If you want to cancel all print jobs in the queue, then click **Printer > Cancel All Documents**.

### **For Macintosh users**

**1** Click the printer icon on the Dock.

**2** From the print queue dialog, choose the job you want to cancel, and then click **Delete**.

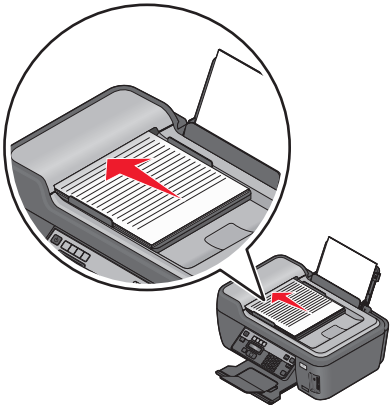
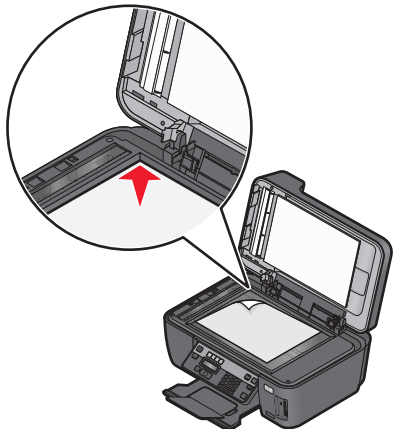

# Copying

ADF	Scanner glass
 <p>Use the ADF for multiple-page documents.</p> <p><b>Note:</b> The ADF is available only on select models. If you purchased a printer without an ADF, then load original documents or photos on the scanner glass.</p>	 <p>Use the scanner glass for single pages, small items (such as postcards or photos), transparencies, photo paper, or thin media (such as magazine clippings).</p>

## Tips for copying

- When using the ADF, adjust the paper guide on the ADF to the width of the original document.
- When using the scanner glass, close the scanner lid to avoid dark edges on the scanned image.
- Do *not* load postcards, photos, small items, transparencies, photo paper, or thin media (such as magazine clippings) into the ADF. Place these items on the scanner glass.

## Making copies

- 1 Load paper.
- 2 Load an original document faceup into the ADF or facedown on the scanner glass.
- 3 From the printer control panel, press .
- 4 Press the arrow buttons to select the number of copies, and then press the **Color/Black** button to set a color or black-and-white copy.  
When you select color or black-only printing, the light near your choice comes on.
- 5 Press .

## Copying photos

- 1 Load photo paper.
- 2 Place a photo facedown on the scanner glass.
- 3 From the printer control panel, press .

- 4 Press **OK** until **Photo Reprint** appears.
- 5 Press the arrow buttons to scroll to **Yes**, and then press **OK**.
- 6 Press the arrow buttons to select the desired photo size, and then press **OK**.
- 7 Press .

**Note:** For best results, allow the prints to dry at least 24 hours before stacking, displaying, or storing.

## Enlarging or reducing images

- 1 Load paper.
- 2 Load an original document facedown on the scanner glass.
- 3 From the printer control panel, press .
- 4 Press **OK** until **Resize** appears.
- 5 Press the arrow buttons until the setting that you want appears.



### Notes:

- If you select Custom %, then press **OK**, and then press the arrow buttons to select the desired custom percent value. Press **OK** to save the setting.
- If you select Borderless, then the printer will reduce or enlarge the document or photo as necessary to print a borderless copy on the paper size that you selected. For best results with this resize setting, use photo paper and set the paper type to Photo, or let the printer automatically detect the paper type.

- 6 Press .

**Note:** After the copy job is finished, press  to reset the settings to the default. The resize setting also switches to 100% after two minutes of printer inactivity.

## Adjusting copy quality

- 1 Load paper.
- 2 Load an original document faceup into the ADF or facedown on the scanner glass.
- 3 From the printer control panel, press .
- 4 Press **OK** until **Quality** appears.
- 5 Press the arrow buttons to set the copy quality to Automatic, Draft, Normal, or Photo.
- 6 Press .

## Making a copy lighter or darker

- 1 Load paper.
- 2 Load an original document faceup into the ADF or facedown on the scanner glass.
- 3 From the printer control panel, press .

4 Press **OK** until **Lighter/Darker** appears.

5 Press the arrow buttons to adjust the slider.

**Note:** Pressing the left arrow button makes the copy lighter, and pressing the right arrow button makes the copy darker.

6 Press .

## Collating copies using the printer control panel

If you print multiple copies of a document, then you can choose to print each copy as a set (collated) or to print the copies as groups of pages (not collated).

**Collated**



**Not collated**



1 Load paper.

2 Load an original document faceup into the ADF or facedown on the scanner glass.

3 From the printer control panel, press .

4 Press the arrow buttons to select the number of copies, and then press **OK**.

5 Press **OK** until **Collate** appears.

6 Press the arrow buttons to scroll to **On**.

7 Press .

## Repeating an image on one page

You can print the same page image multiple times on one sheet of paper. This option is helpful when creating items such as labels, decals, flyers, and handouts.

1 Load paper.

2 Load an original document faceup into the ADF or facedown on the scanner glass.

3 From the printer control panel, press .

4 Press **OK** until **Copies per Sheet** appears.

5 Press the arrow buttons to select the number of times that an image is repeated on a page: once, four times, nine times, or 16 times.

6 Press .

# Copying multiple pages on one sheet

The Pages per Sheet setting lets you copy multiple pages on one sheet by printing smaller images of each page. For example, you can condense a 20-page document into five pages if you use this setting to print four page images per sheet.

- 1 Load paper.
- 2 Load an original document faceup into the ADF or facedown on the scanner glass.
- 3 From the printer control panel, press .
- 4 Press **OK** until **Pages per Sheet** appears.
- 5 Press the arrow buttons to select the number of pages that you want to copy on a sheet of paper. You may choose to copy one, two, or four page images on a sheet.

**Note:** If you are copying four pages in landscape format, scan pages 3 and 4 first, and then scan pages 1 and 2.



- 6 Press .

# Making a duplex copy

## Making a duplex copy automatically

The automatic duplex unit, available only on select printer models, supports letter- and A4-size paper. If you purchased a model without automatic duplex, or if you need to make duplex copies using other paper sizes, then see the instructions for making a duplex copy manually.

**Note:** You cannot make duplex copies on envelopes, card stock, or photo paper.

- 1 Load paper.
- 2 Load an original document faceup into the ADF or facedown on the scanner glass.
- 3 From the printer control panel, press .
- 4 Press **OK** until **2-Sided Copies** appears.
- 5 Choose the duplex option that matches your original document:
  - If you are copying a one-sided document, then press the arrow buttons to scroll to **1 to 2**.
  - If you are copying a two-sided document, then press the arrow buttons to scroll to **2 to 2**.
- 6 Press  to save the first page of the document to the printer memory.
- 7 Follow the instructions on the display.

## Making a duplex copy manually

- 1 Load paper.
- 2 Load an original document faceup into the ADF or facedown on the scanner glass.
- 3 From the printer control panel, press .



4 Press the arrow buttons to select the number of copies, and then press the **Color/Black** button to set a color or black-and-white copy.

When you select color or black-only printing, the light near your choice comes on.

5 Press  to print on one side of the paper.

6 Load the next page of the document.

- If you are copying a one-sided document, then load the next page faceup into the ADF or facedown on the scanner glass.
- If you are copying a two-sided document, then flip the original document, and then reload it faceup into the ADF or facedown on the scanner glass.

7 Remove the paper from the paper exit tray, and then reload the paper to print the other side of the document.

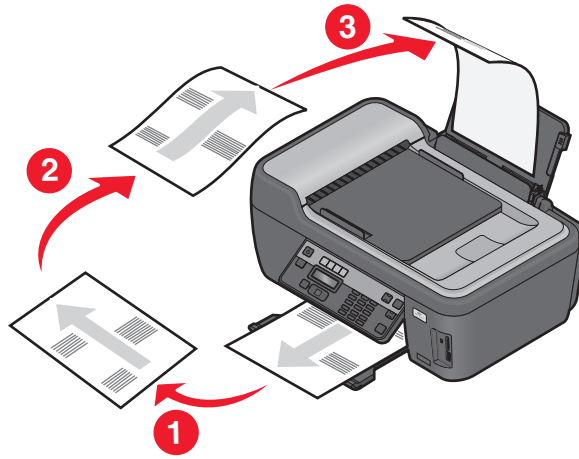

8 Press .

## Canceling copy jobs

To cancel a copy job, press .

Scanning stops and the printer returns to the previous menu.

# Scanning

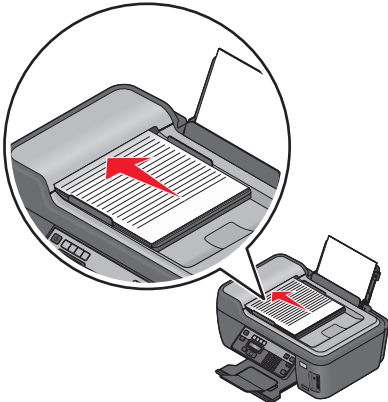
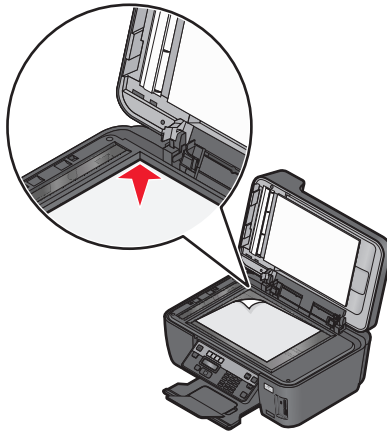
ADF	Scanner glass
 <p>Use the ADF for multiple-page documents.</p> <p><b>Note:</b> The ADF is available only on select models. If you purchased a printer without an ADF, then load original documents or photos on the scanner glass.</p>	 <p>Use the scanner glass for single pages, small items (such as postcards or photos), transparencies, photo paper, or thin media (such as magazine clippings).</p>

## Tips for scanning

- When using the ADF, adjust the ADF paper guide to the width of the original document.
- When using the scanner glass, close the scanner lid to avoid dark edges on the scanned image.
- Do *not* load postcards, photos, small items, transparencies, photo paper, or thin media (such as magazine clippings) into the ADF. Place these items on the scanner glass.
- Select the PDF file type if you want to scan multiple pages and save them as one file.
- To initiate network scanning from the printer, make sure that “Enable network scan to computer” is selected in the General tab of the Scan Center. This is available only in Mac OS X version 10.6.

## Scanning to a local or network computer

- 1 Load an original document faceup into the ADF or facedown on the scanner glass.
- 2 From the printer control panel, press .
- 3 Press the arrow buttons to scroll to **Computer** or **Network**, and then press **OK**.
- 4 Press the arrow buttons to select the name of a local or network computer, and then press **OK**.

The local or network computer is the destination that will receive the scan. Wait until the printer has finished downloading a list of the scan applications available on the selected computer.

### Notes:

- If the printer is connected only to a local computer, then the printer will automatically download a list of the scan applications.
- You may be prompted to enter a PIN if the computer requires it. Enter the PIN using the keypad.
- To assign a computer name and a PIN to the computer, see the Help for the printer software associated with your operating system.

- 5 Press the arrow buttons to select an application, and then press **OK**.
- 6 Press the arrow buttons to select the resolution quality and the original image size. Press **OK** each time you make a selection.
- 7 Press  to start scanning.

The scan is complete when the application you selected in step 5 opens on the destination computer, and the scan appears within the application as a new file.

## Scanning to a flash drive or memory card

Before you begin, make sure your flash drive or memory card is not write protected.

- 1 Load an original document faceup into the ADF or facedown on the scanner glass.
- 2 From the printer control panel, press .
- 3 When **Scan to** appears on the display, insert the flash drive or memory card.
- 4 Press the arrow buttons to scroll to **USB Flash Drive or Memory Card**, and then press **OK**.
- 5 Press the arrow buttons to select the resolution quality, the type of output you want to create, and the original image size. Press **OK** each time you make a selection.

**Note:** Select the PDF file type if you want to scan multiple pages and save them as one file.

- 6 Press  to start scanning.

The scan is complete when a message appears on the printer control panel indicating that the file you scanned has been saved.

## Scanning photos into an editing application

### Using the printer control panel

- 1 Load a photo or photos facedown on the scanner glass.
- 2 From the printer control panel, press .
- 3 Press the arrow buttons to scroll to **Computer** or **Network**, and then press **OK**.
- 4 Press the arrow buttons to select the name of a local or network computer, and then press **OK**.

The local or network computer is the destination that will receive the scan. Wait until the printer has finished downloading the list of scan applications available on the selected computer.

## Notes:

- If the printer is connected only to a local computer, then the printer will automatically download a list of the scan applications.
- You may be prompted to enter a PIN if the computer requires it. Enter the PIN using the keypad.
- To assign a computer name and a PIN to the computer, see the Help for the printer software associated with your operating system.

5 Press the arrow buttons to select a photo editing application, and then press **OK**.

6 Press the arrow buttons to select the resolution quality, the type of output you want to create, and the original image size. Press **OK** each time you make a selection.

7 Press .

The scan is complete when the photo editing application you selected in step 5 opens on the destination computer, and the scan appears within the application as a new file.

## Using the printer software

### For Windows users

1 Load a photo or photos facedown on the scanner glass.

2 Click  or **Start**.

3 Click **All Programs** or **Programs**, and then select the printer program folder from the list.

4 Navigate to:

**Printer Home** > select your printer > **Photo**

- If you want to scan a single photo, or multiple photos as a single image, then select **Single photo**.
- If you want to scan multiple photos at once and save them as separate images, then select **Split into individual photos**.

Scanning starts and the scan progress dialog appears.

5 Save the photo or photos and open in a photo editing application to edit.

### For Macintosh users

1 Load a photo or photos facedown on the scanner glass.

2 From the Applications folder in the Finder, or from the Finder desktop, double-click the printer folder.

3 Double-click **Scan Center** or **All-In-One Center**.

4 From the “What is being scanned?” menu on the main screen, select **Photo**.

5 From the “How will the scanned image be used?” pop-up menu, choose **To be printed** or **To be viewed on monitor/Web page**.

6 From the “Send scanned image to” menu, choose a destination folder or application for the scanned image.

7 If you have several images to scan, then select **Prompt for multiple pages**.

8 Click **Preview/Edit**.

The Scan dialog appears.

9 Adjust the image and scan settings as needed.

10 Click **Scan**.

## Scanning documents into an editing application

An Optical Character Recognition (OCR) application allows you to edit an original text document that has been scanned. In order for this to work, you must have an OCR application stored on a local or network computer and you must be able to choose it from the list of applications when you set up the scan.

When selecting settings for the scan:

- Select to scan to the local computer or network computer where the OCR application is installed.
- Select to scan to the highest resolution.

### For Windows users

- 1 Load an original document faceup into the ADF or facedown on the scanner glass.
- 2 Click  or **Start**.
- 3 Click **All Programs** or **Programs**, and then select the printer program folder from the list.
- 4 Navigate to:  
**Printer Home** > select your printer > **Document**  
Scanning starts and the scan progress dialog appears.
- 5 When the scan is finished, save the document in a word-processing application.
- 6 Open the document in the selected application to edit it.

### For Macintosh users

- 1 Load an original document faceup into the ADF or facedown on the scanner glass.
- 2 From the Applications folder in the Finder, or from the Finder desktop, double-click the printer folder.
- 3 Double-click **Scan Center** or **All-In-One Center**.
- 4 From the “What is being scanned?” area on the main screen, select a document type other than Photo.
- 5 From the “How will the scanned image be used?” pop-up menu, choose **To be edited (OCR)**.
- 6 From the “Send scanned image to” menu, choose a word-processing application to use for editing.
- 7 Click **Scan**.
- 8 Open the scanned document from a word-processing application to edit it.

# Scanning directly to e-mail using the printer software

## For Windows users

- 1 Load an original document faceup into the ADF or facedown on the scanner glass.
- 2 Click  or **Start**.
- 3 Click **All Programs** or **Programs**, and then select the printer program folder from the list.
- 4 Navigate to:  
**Printer Home** > select your printer > **Email**
- 5 Select **Photo**, **Document**, or **PDF**.

**Note:** You can select Document only if an OCR application is stored on your computer.

Scanning starts and the scan progress dialog appears.

When the scan is finished, a new e-mail message is created with the scanned document automatically attached.

- 6 Compose your e-mail message.

**Note:** If your e-mail program does not open automatically, then you can scan the document to the computer and then send it through e-mail as an attachment.

## For Macintosh users

- 1 Load an original document faceup into the ADF or facedown on the scanner glass.
- 2 From the Applications folder in the Finder, or from the Finder desktop, double-click the printer folder.
- 3 Double-click **Scan Center** or **All-In-One Center**.
- 4 From the “What is being scanned?” area on the main screen, select a document type.
- 5 From the “How will the scanned image be used?” menu, choose **To be viewed on monitor/web page**.
- 6 From the “Send scanned image to” menu, choose an e-mail application.
- 7 Click **Scan**.

When the scan is finished, a new e-mail message is created with the scanned document automatically attached.

- 8 Compose your e-mail message.

## Scanning to a PDF

### For Windows users

- 1 Load an original document faceup into the ADF or facedown on the scanner glass.
- 2 Click  or **Start**.
- 3 Click **All Programs** or **Programs**, and then select the printer program folder from the list.

- 4 Navigate to:  
**Printer Home** > select your printer > **PDF**  
Scanning starts and the scan progress dialog appears.
- 5 Save the document as a PDF.

## For Macintosh users

- 1 Load an original document faceup into the ADF or facedown on the scanner glass.
- 2 From the Applications folder in the Finder, or from the Finder desktop, double-click the printer folder.
- 3 Double-click **Scan Center** or **All-In-One Center**.
- 4 From the “What is being scanned?” area on the main screen, select a document type.
- 5 Customize the settings as needed.
- 6 Click **Scan**.
- 7 Save the document as a PDF.

## Scanning FAQ

### How can I improve the quality of a scan?

- Make sure your original documents are in good condition.
- Make sure the application that receives the scanned document is appropriate. For example, if you are scanning a photo to edit it, then make sure you choose a photo editing application to receive the scan. If you are scanning a document to edit the text, then make sure you choose an OCR application.
- Use a high resolution.

### How do I scan in black and white?

Color is the default for all scans. To scan in black and white, press the **Color/Black** button on the printer control panel to switch from color to black and white.

### Why am I being asked for a PIN?

PINs are a security measure used to restrict the scanned information from going into certain locations, or to keep what is being scanned from being seen or used by others. You may be prompted to enter a PIN if the network computer you are scanning to requires one.

To learn how PINs get assigned to network computers, see the Help for the printer software associated with your operating system.

## What is an application list, and how do I update it?

When you scan a file, you can choose which application to use to open it on your computer. The printer downloads this application list from your computer when scanning for the first time. If you do not see the application you want on the list, or if you install new applications on your computer, then update the application list in the printer.

### Updating the application list

- 1 From the printer control panel, press .
- 2 Press the arrow buttons to scroll to **Computer** or **Network**.
- 3 Select a local or network computer to receive the scan and then press **OK**.  
Wait until the printer has finished downloading a list of the scan applications available on the selected computer.
- 4 Select **REFRESH** from the list of scan applications.  
This updates the application list in the printer.

### Canceling scan jobs

Press **X** on the printer control panel, or click **Cancel** on the computer screen.



# Faxing

**CAUTION—SHOCK HAZARD:** Do not use the fax feature during a lightning storm. Do not set up this product or make any electrical or cabling connections, such as the power supply cord or telephone, during a lightning storm.

## Setting up the printer to fax

### Scenario 1: Standard telephone line

Check the scenarios below and follow the setup that is applicable to your telephone line.

#### Setup 1: Printer is connected to a dedicated fax line

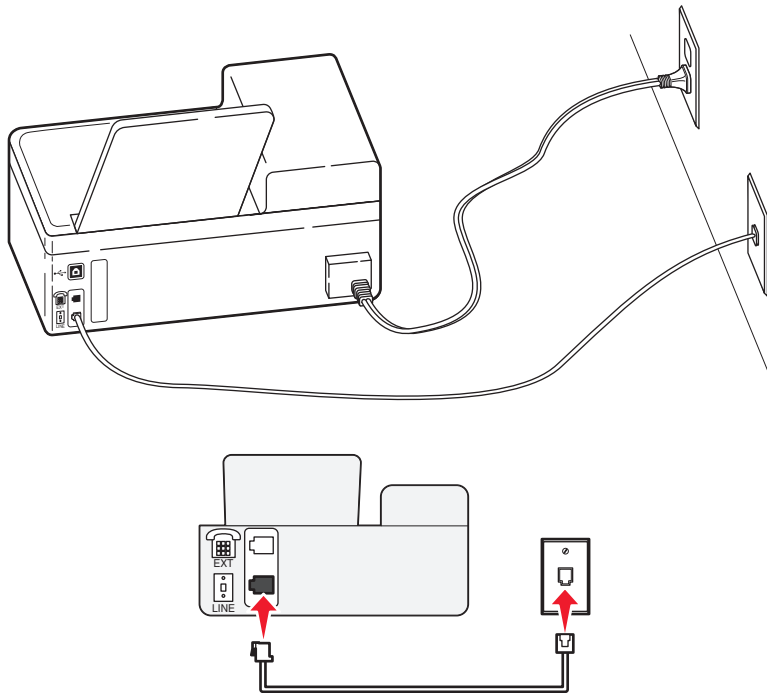

#### Tips for this setup:

- You can set the printer to receive faxes automatically (Auto Answer On) or manually (Auto Answer Off).
- If you want to receive faxes automatically (Auto Answer On), then you may set the printer to pick up on any number of rings that you want.

## Setup 2: Printer is sharing the line with an answering machine

Connected to the same telephone wall jack

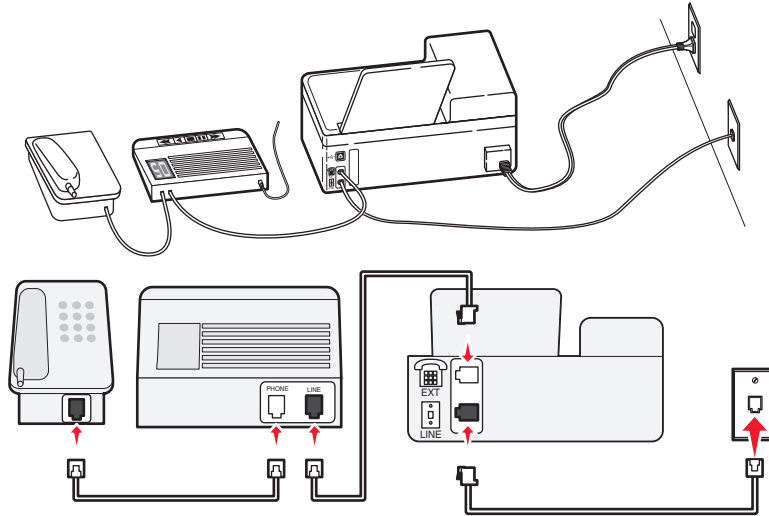

Connected to different wall jacks

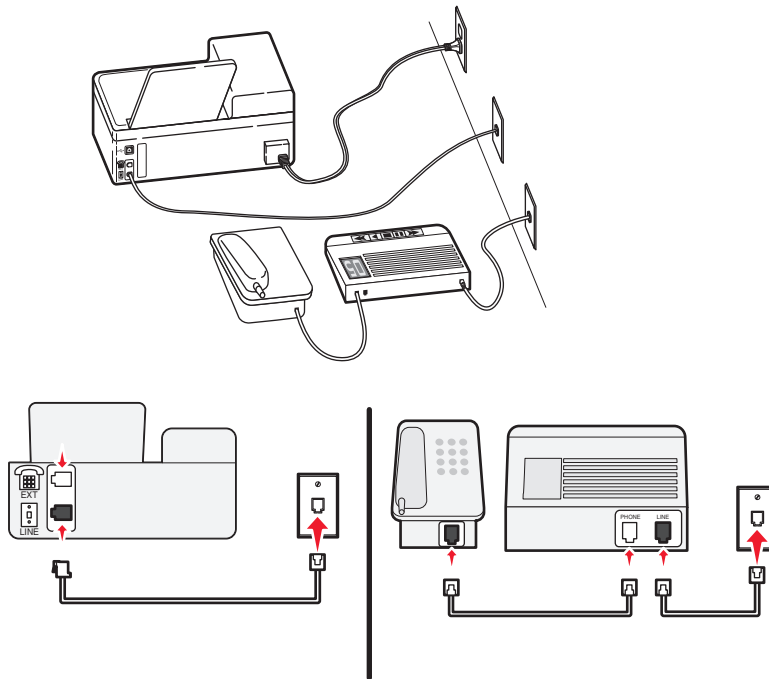

### Tips for this setup:

- If you have only one telephone number on your line, or if you do not subscribe to a distinctive ring service, then you need to set the printer to receive faxes automatically (Auto Answer On).
- Set the printer to pick up calls two rings after the answering machine. For example, if the answering machine picks up calls after four rings, then set the printer to pick up after six rings. This way, the answering machine picks up calls first and your voice calls are received. If the call is a fax, then the printer detects the fax signal on the line and takes over the call.

- If you subscribe to a distinctive ring service provided by your telephone company, then make sure that you set the correct ring pattern for the printer. Otherwise, the printer will not receive faxes even if you have set it to receive faxes automatically.

### Setup 3: Printer is sharing the line with a telephone subscribed to voice mail service

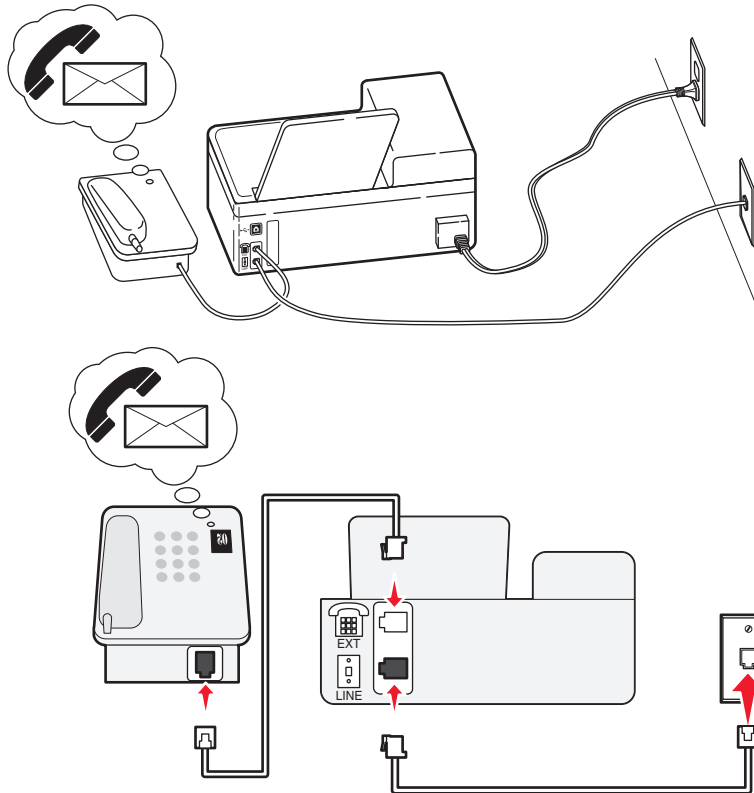

#### Tips for this setup:

- This setup works best if you subscribe to a distinctive ring service. If you have distinctive ring service, then make sure that you set the correct ring pattern for the printer. Otherwise, the printer will not receive faxes even if you have set it to receive faxes automatically.
- If you have only one telephone number on your line, or if you do not have distinctive ring service, then you need to set the printer to receive faxes manually (Auto Answer Off).  
When you answer the telephone and you hear fax tones, press \*9\* or the manual answer code on the telephone to receive the fax.
- You can also set the printer to receive faxes automatically (Auto Answer On), but you need to turn off the voice mail service when you are expecting a fax. This setting works best if you are using voice mail more often than fax.

## Scenario 2: Digital Subscriber Line (DSL)

Follow this setup if you have a Digital Subscriber Line (DSL).

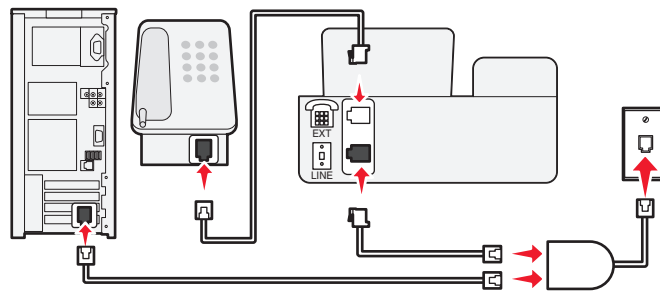
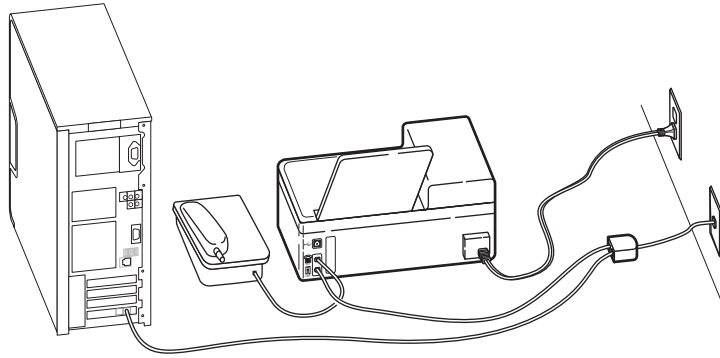

A Digital Subscriber Line splits your regular telephone line into two channels: voice and Internet. Telephone and fax signals travel through the voice channel, and Internet signals pass through the other channel. This way, you can use the same line for analog voice calls (including faxing) and digital Internet access.

To minimize interference between the two channels and ensure a quality connection, you need to install a DSL filter for the analog devices (fax machine, telephone, answering machine) in your network. Interference causes noise and static on the telephone, failed and poor quality faxes for the printer, and slow Internet connection on your computer.

To install a filter for the printer:

- 1 Connect the line port of the DSL filter to the wall jack.
- 2 Connect a telephone cable from the  port on the back of the printer to the phone port on the DSL filter.
- 3 To continue using a computer for Internet access, connect the computer to the DSL HPN port on the DSL filter.

### Scenario 3: VoIP telephone service

Follow this setup if you have telephone service from a Voice over Internet Protocol (VoIP) provider.

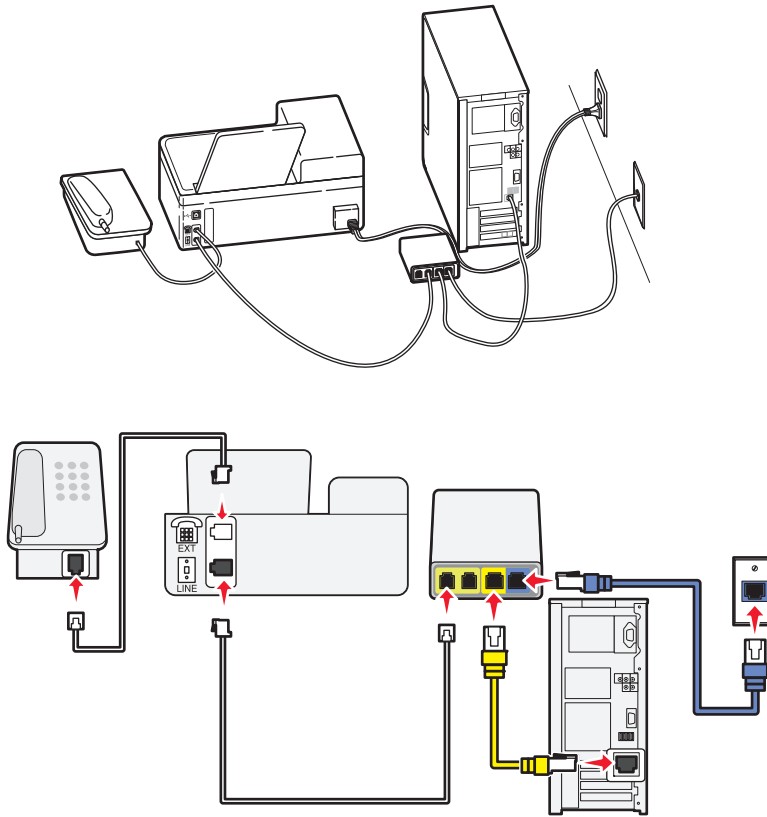

#### Tips for this setup:

- Connect the printer to the port labeled **Phone Line 1** or **Phone Port** on the VoIP adapter. The port labeled **Phone Line 2** or **Fax Port** is not always active. You may need to pay extra to your VoIP provider if you want to activate the second phone port.
- To make sure that the phone port on the VoIP adapter is active, plug an analog telephone into the phone port, and then listen for a dial tone. If you hear a dial tone, then the port is active.
- If you need two phone ports for your devices but do not want to pay extra, then do not plug the printer into the second phone port. You can use a phone splitter. Plug the phone splitter into the **Phone Line 1** or **Phone Port**, and then plug the printer and telephone into the splitter.

**Note:** Make sure you use a phone splitter, *not* a line splitter. To make sure that you are using the correct splitter, plug an analog telephone into the splitter and then listen for a dial tone.

## Scenario 4: Digital telephone service through a cable provider

### Setup 1: Printer is connected directly to a cable modem

Follow this setup if you normally connect your telephone to a cable modem.

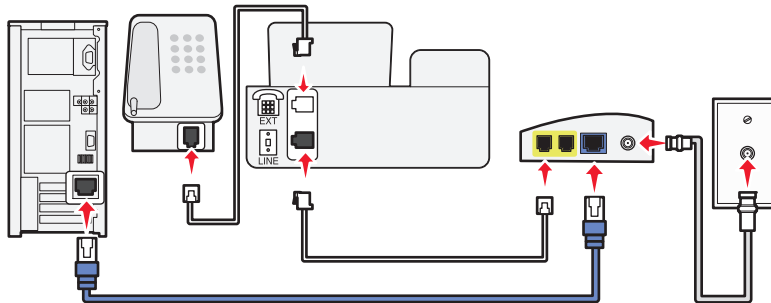
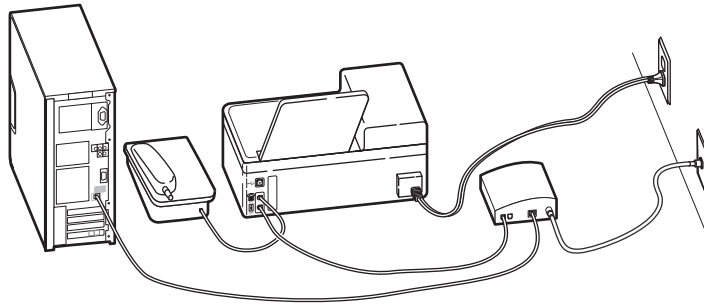

#### Tips for this setup:

- Connect the printer to the port labeled **Phone Line 1** or **Phone Port** on the cable modem. The port labeled **Phone Line 2** or **Fax Port** is not always active. You may need to pay extra to your cable provider if you want to activate the second phone port.
- To make sure that the phone port on the cable modem is active, plug an analog telephone into the phone port, and then listen for a dial tone. If you hear a dial tone, then the port is active.
- If you need two phone ports for your devices but do not want to pay extra, then do not plug the printer into the second phone port. You can use a phone splitter. Plug the phone splitter into the **Phone Line 1** or **Phone Port**, and then plug the printer and telephone into the splitter.

**Note:** Make sure you use a phone splitter, *not* a line splitter. To make sure that you are using the correct splitter, plug an analog telephone into the splitter and then listen for a dial tone.

## Setup 2: Printer is connected to a wall jack; cable modem is installed elsewhere in the house

Follow this setup if your cable provider activated the wall jacks in your house so that you do not have to plug your devices into the cable modem. Your cable telephone service comes from the wall jacks.

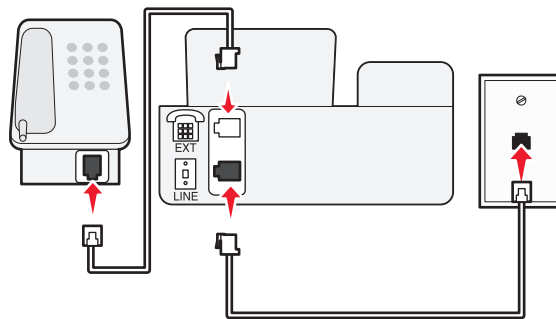
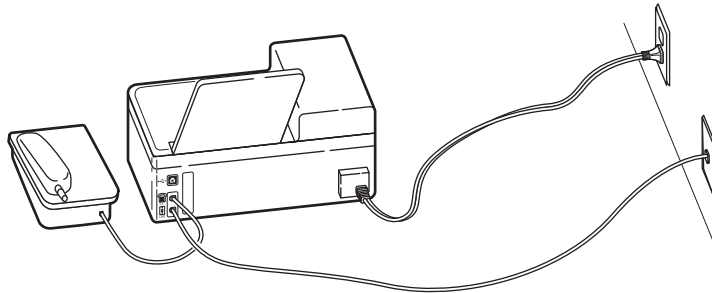

## Scenario 5: Country-specific setup

Different countries have different types of telephone wall jacks. The most common wall jack is the Registered Jack-11 (RJ-11), the standard adopted by most countries. You need to have an RJ-11 plug, or a telephone cable that has an RJ-11 connector, so you can connect a device to an RJ-11 wall jack.

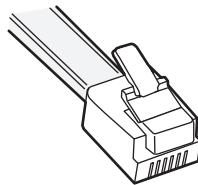

The fax ports on the back of the printer and the telephone cable that comes with the printer have RJ-11 connectors. If you have a different type of connector in your country or region, then you may need to use an RJ-11 adapter.

### Connecting the printer to a non-RJ-11 wall jack

To set up the printer for faxing, connect the printer to the RJ-11 adapter that comes with the printer, and then plug the adapter into the wall jack. You can also connect an additional device (telephone or answering machine) to the same telephone line. If the additional device does not have an RJ-11 connector, then connect it directly to the wall jack. Do *not* remove the wrap plug from the ☎ port of the printer.

**Note:** The printer may not come with an RJ-11 adapter in your country or region.

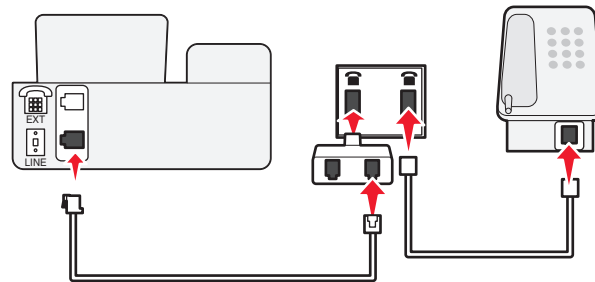
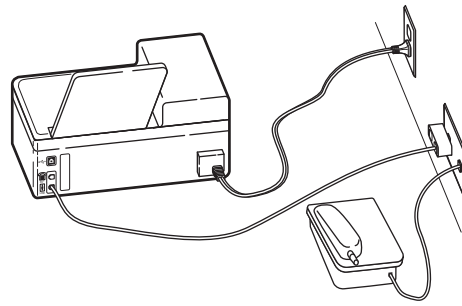

If the additional device (telephone or answering machine) has an RJ-11 connector, then you can remove the wrap plug and plug the device into the ☎ port of the printer.

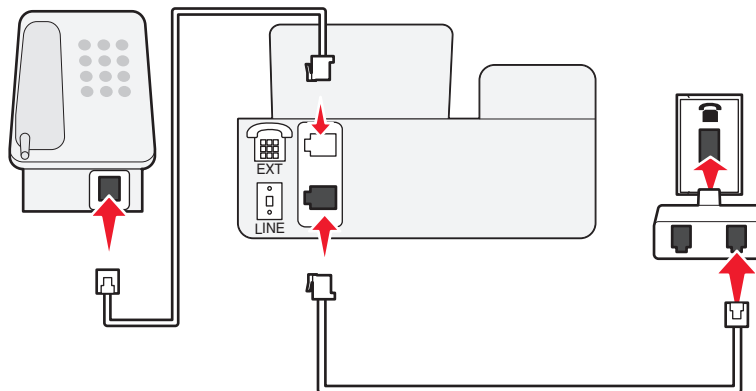
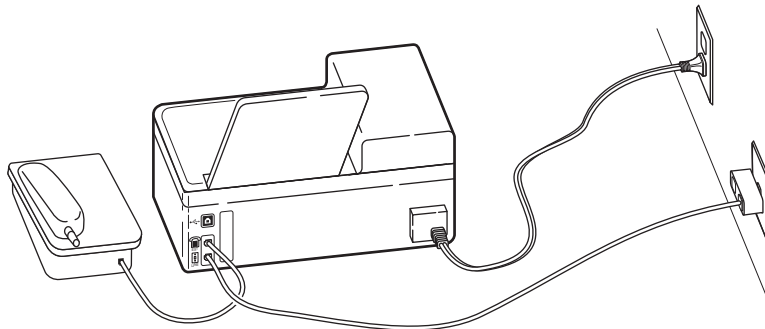



## Connecting the printer in countries that use serial connection

In some countries or regions, you need to plug all devices into the wall jack. You cannot plug a telephone or answering machine into the ☎ port of the printer. This is called serial connection.

Austria

Germany

Portugal

Belgium

Ireland

Spain

Denmark

Italy

Sweden

France

Netherlands

Switzerland

Finland

Norway

United Kingdom

**Warning—Potential Damage:** If your country is on the list, then do *not* remove the wrap plug from the ☎ port of the printer. It is necessary for the proper functioning of the devices on the telephone line.

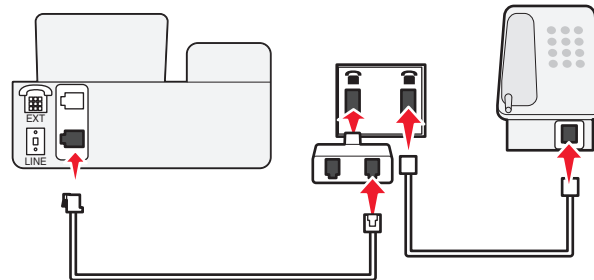
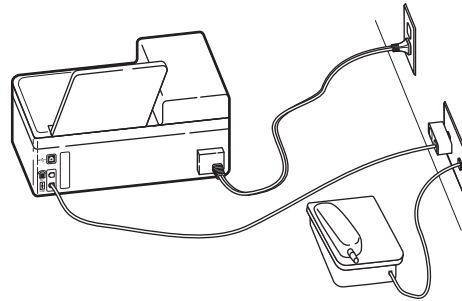

## Connecting the printer to a wall jack in Germany

The German wall jack has two kinds of ports. The N ports are for fax machines, modems, and answering machines. The F port is for telephones.

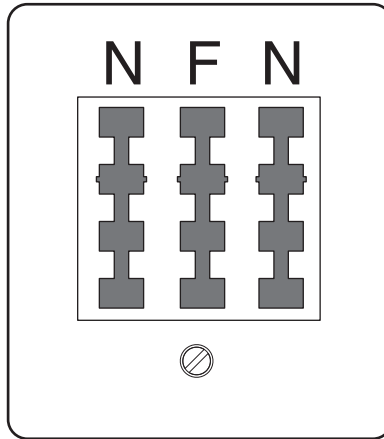

Connect the printer to any of the N ports.

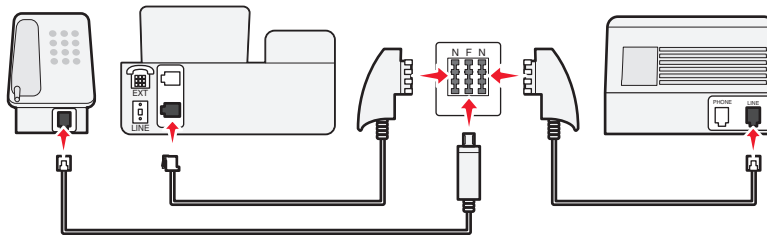
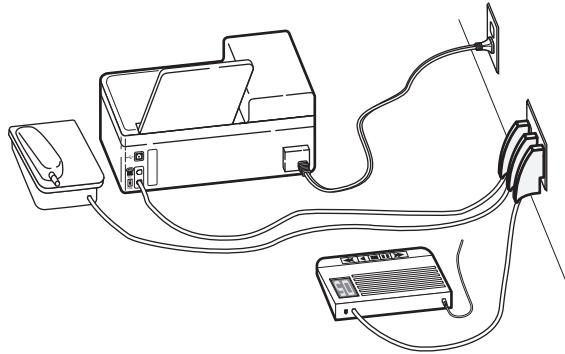

## Entering your user information



Your user information includes your name or your company name, your fax number (your fax number is your telephone number, unless you have a dedicated fax telephone line), and the time and date on your fax machine when a transmission is made. This information appears in the header and footer of the faxes that you send.

In some countries, you cannot send a fax without this information. Some fax machines also block faxes without sender information, so make sure that you enter this information in your printer.

### Setting the fax header

- 1 From the printer control panel, press .
- 2 Press the arrow buttons to scroll to **Fax Setup**, and then press **OK**.
- 3 Press the arrow buttons to scroll to **Dialing and Sending**, and then press **OK**.
- 4 Press **OK** again to select **Your Fax Name**.
- 5 Use the keypad to enter your name or your company name, and then press **OK**.
- 6 Press the arrow buttons to scroll to **Your Fax Number**, and then press **OK**.
- 7 Use the keypad to enter your fax number or your telephone number, and then press **OK**.

### Setting the fax footer

- 1 Press .
- 2 Press the arrow buttons to scroll to **Fax Printing**, and then press **OK**.
- 3 Press the arrow buttons to scroll to **Fax Footer**, and then press **OK**.
- 4 Press **OK** again to select **On**.
- 5 During the initial setup of your printer, you were prompted to enter the date and time. If you have not entered this information, then do the following:
  - a Press  twice.
  - b Press the arrow buttons to scroll to **Device Setup**, and then press **OK**.
  - c Press the arrow buttons to scroll to **Date/Time**, and then press **OK**.
  - d Enter the date using the keypad, and then press **OK**.
  - e Enter the time using the keypad, and then press **OK**.

# Configuring the fax settings

You can configure the fax settings through the printer control panel or the fax software. If you configure the fax settings in the printer control panel, then the fax software imports those settings. The changes appear the next time you launch the fax software. The printer also saves the settings that you choose in the fax software, unless you set the printer to block changes made from the computer.

## Configuring fax settings using the printer control panel

- 1 From the printer control panel, press .
- 2 Press the arrow buttons to scroll to **Fax Setup**, and then press **OK**.
- 3 Configure the fax settings using the selections in the menu:

From here	You can
Address Book	Set up, view, or print the Address Book.
Reports	<ul style="list-style-type: none"><li>• Print activity logs. Activity logs let you view the sent and received fax history of your printer.</li><li>• Print confirmation pages or transmission reports. These reports let you know if the faxes that you send are sent successfully.</li></ul>
Ring and Answering	<ul style="list-style-type: none"><li>• Set the printer to receive faxes automatically or manually. Turn Auto Answer to On or Off.</li><li>• Adjust the ringing volume.</li><li>• Set the number of rings. This is important if you choose to receive faxes automatically (Auto Answer On).</li><li>• Set the distinctive ring. If you subscribe to the distinctive ring feature on your telephone line, then set the correct pattern for the printer in this menu.</li><li>• Enable fax forwarding.</li><li>• Set a manual answer code. This is the code you press to receive faxes manually.</li><li>• Set the Caller ID pattern that you want. Some countries or regions have multiple patterns.</li></ul>
Fax Printing	<ul style="list-style-type: none"><li>• Set the printer to print incoming faxes to fit a page.</li><li>• Set the fax footer.</li></ul>

From here	You can
Dialing and Sending	<ul style="list-style-type: none"> <li>• Set your fax name and fax number.</li> <li>• Adjust the dialing volume.</li> <li>• Set the dial method, redial time, number of redial attempts, dialing prefix, and fax sending speed.</li> <li>• Convert sent faxes into modes that receiving fax machines recognize. Otherwise, such faxes are aborted.</li> <li>• Enable error correction during transmission.</li> <li>• Set whether the printer scans the original document before or after dialing the recipient.</li> </ul> <p>Set the printer to scan before dialing so that you do not have to scan the document again if the fax fails. The scanned document is saved in the printer memory. The printer can then retrieve it and automatically redial the number.</p> <p>If you set the printer to scan after dialing, then the printer does not automatically redial, even when the phone line is busy.</p>
Fax Blocking	Block unwanted incoming faxes.

## Configuring fax settings using the fax software

Before opening the fax software to configure the fax settings, make sure that:

- The printer is properly connected to the telephone line.
- The printer is turned on and connected to the computer.
- The printer is not in Power Saver mode. If the printer is in Power Saver mode, then press  to wake up the printer.

### Using the Fax Setup Wizard in Windows

- 1 Click  or **Start**.
- 2 Click **All Programs** or **Programs**, and then select the printer program folder from the list.
- 3 Click **Printer Home**.
- 4 Click the **Fax** tab, and then click **Set up the printer to fax**.  
The Fax Setup Wizard opens.
- 5 Run the Fax Setup Wizard. Make sure you select the correct telephone service and connection. The wizard configures optimal fax settings based on your connection.

**Note:** If you want to configure the advanced fax settings, then click **Configure the advanced fax settings** in the Fax tab of the Printer Home. This launches the Printer Setup Utility.

### Using the Printer Settings or Fax Setup Utility in Macintosh

- 1 From the Applications folder in the Finder, or from the Finder desktop, double-click the printer folder.
- 2 Double-click **Printer Settings** or **Fax Setup Utility**.
- 3 Configure the fax settings using the software.

For more information, click **Help** or  to view the help information for the fax software.

# Creating a contact list

You can create a contact list using the Address Book in the printer control panel or the phone book in the fax software. If you create a contact list in the printer control panel, then the fax software automatically saves those contacts as Speed Dial entries. Likewise, when you add contacts to the Speed Dial list of the fax software, the printer automatically saves them to the printer Address Book.

You can save up to 89 contacts and 10 fax groups in the contact list.

## Creating a contact list using the printer control panel

- 1 From the printer control panel, press .
- 2 Press the arrow buttons to scroll to **Fax Setup**, and then press **OK**.
- 3 Press **OK** again to select **Address Book**.
- 4 To add a fax number to your Address Book:
  - a Press the arrow buttons to scroll to **Add**.
  - b Press **OK**.
  - c Press **OK** again to select the Speed Dial number.

**Note:** Numbers 1 to 89 are for individual contacts. Numbers 90 to 99 are for group contacts. When you send a fax, you can enter the Speed Dial number instead of the fax number of your contact.
  - d Use the keypad to enter the fax number in the Enter Number field, and then press **OK**.
  - e Use the keypad to enter the contact name in the Enter Name field, and then press **OK** to save the entry.
  - f Repeat steps 4b through 4e to add additional entries as needed. You can enter up to 89 fax numbers.
- 5 To add a fax group:
  - a Press **OK** to select **Add**.
  - b Using the keypad, enter any number from 90 to 99, and then press **OK**.
  - c Enter a fax number in the Enter Number field, and then press **OK**.
  - d If you want to add another contact to the group, press the arrow buttons to scroll to **Yes**, and then press **OK**.
  - e Repeat step 5d as necessary. You can enter up to 30 fax numbers for the group.

If you do not want to add another fax number, then press **OK** to select **No**.
  - f Enter the group name in the Enter Name field, and then press **OK** to save the entry.

## Creating a contact list using the fax software

### For Windows users

- 1 Click  or **Start**.
- 2 Click **All Programs** or **Programs**, and then select the printer program folder from the list.
- 3 Click **Printer Home** > **Fax** tab > **Edit contact list**.

The Contacts tab of the Printer Setup Utility opens.
- 4 Click **Select from phonebook**.

5 From the Phonebook field, choose a phone book.

6 Select the contact that you want to add, and then click **Add to or change list** to import the contact.

**Note:** To add contacts, you need to import contacts from the phone books on your computer that are supported by the fax software. In addition to the software Address Book, you may also have phone books of the mail clients installed on your computer, such as Microsoft Outlook.

7 Click **OK**.

### For Macintosh users

1 From the Applications folder in the Finder, or from the Finder desktop, double-click the printer folder.

2 Double-click **Printer Settings** or **Fax Setup Utility**.

3 Click the **Speed Dials** tab.

- To add contacts, click the **Individuals** tab.
- To add fax groups, click the **Groups** tab.

4 Click  to open the Address Book.

**Note:** To add contacts, you need to import contacts from the Address Book on your Macintosh computer. If the contact is not in the Mac Address Book, then add the contact first to the address book and then import it.

5 From the Address Book, click and drag the contacts that you want to add to the Speed Dial list.

For more information, click **Help** or  to view the help information for the fax software.

## Sending faxes

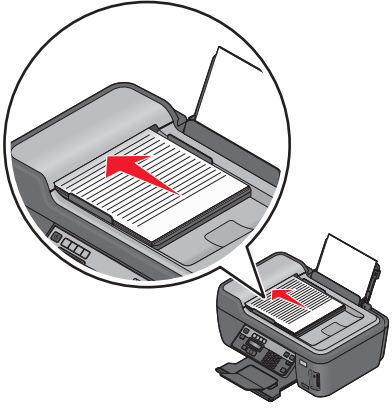
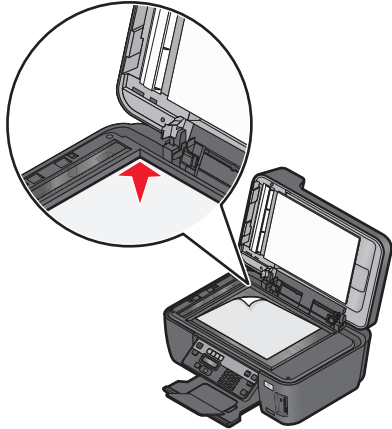

ADF	Scanner glass
 <p>Use the ADF for multiple-page documents.</p> <p><b>Note:</b> The ADF is available only on select models. If you purchased a printer without an ADF, load original documents or photos on the scanner glass.</p>	 <p>Use the scanner glass for single pages, small items (such as postcards or photos), transparencies, photo paper, or thin media (such as magazine clippings).</p>

## Tips for sending faxes

Before you send a fax:

- Make sure that the printer is on and connected to a working telephone, DSL, or VoIP line. The line is working if you hear a dial tone.
- Load an original document faceup into the ADF or facedown on the scanner glass.
- When using the ADF, adjust the paper guide on the ADF to the width of the original document.
- When using the scanner glass, close the scanner lid to avoid dark edges on the scanned image.

## Sending faxes using the printer control panel

- 1 From the printer control panel, press .
- 2 Enter or select a fax recipient:
  - Enter a fax number, and then press **OK**.
  - Press **Address Book** to select a number from the Speed Dial or Group Dial list, and then press **OK** twice.
- 3 If you want to send a fax to a group of recipients (broadcast fax), press the arrow buttons to scroll to **Yes**, and then press **OK**.  
Enter another number or select from the address book.  
Repeat the step to add more recipients.
- 4 Press the **Color/Black** button to select a color or black-and-white fax.
- 5 Press  to start the fax job.

### Tip:

- You can send a broadcast fax to up to 30 recipients.

## Sending faxes using the computer

### For Windows users

- 1 With a document open, click **File** → **Print**.
- 2 From the Printer Name menu, select the fax version of your printer, and then click **OK**.  
The Send Fax Wizard appears.
- 3 Follow the instructions on the computer screen.

### For Macintosh users

- 1 With a document open, choose **File** > **Print**.
- 2 From the Printer pop-up menu, select the fax version of your printer.  
**Note:** In order to see the fax options on the Print dialog, you must use the fax driver for your printer. If the fax version of the printer is not on the list, choose **Add a printer**, and then choose the fax version of the printer.
- 3 Enter the name and number of the recipient.
- 4 Click **Fax**.



# Receiving faxes

## Tips for receiving faxes

When receiving faxes:

- Make sure that the printer is on and connected to a working telephone, DSL, or VoIP line. The line is working if you hear a dial tone.
- If you set the printer to receive faxes manually (Auto Answer Off), then make sure that the ringer volume is not set to Off.
- If you have set the printer to receive faxes automatically (Auto Answer On), then load paper in the printer.

## Receiving faxes automatically

1 Make sure that Auto Answer is on:

- a From the printer control panel, press .
- b Press the arrow buttons to scroll to **Fax Setup**, and then press **OK**.
- c Press the arrow buttons to scroll to **Ringing and Answering**, and then press **OK**.
- d Press **OK** again to select **Auto Answer**.
- e If Auto Answer is not set to On, press the arrow buttons to scroll to **On**, and then press **OK** to save the setting.

2 Set the number of rings before the printer picks up incoming faxes:

- a Press the arrow buttons to scroll to **Pick Up On**, and then press **OK**.
- b Press the arrow buttons to scroll to the number of rings that you want, and then press **OK** to save the setting.

When the number of rings you set is detected, the printer automatically receives the incoming fax.

**Warning—Potential Damage:** Do not touch the cables or the  and  ports while actively receiving a fax.

### Tips:

- If the printer is sharing the line with other analog devices (telephone, answering machine), then set the printer to pick up calls two rings after the answering machine. For example, if the answering machine picks up calls after four rings, then set the printer to pick up after six rings. This way, the answering machine picks up calls first and your voice calls are received. If the call is a fax, then the printer detects the fax signal on the line and takes over the call. If the printer is on a dedicated fax line, then you may set the printer to pick up on any number of rings.
- If you have multiple numbers on a single line, or if you subscribe to a distinctive ring service provided by your telephone company, then make sure that you set the correct ring pattern for the printer. Otherwise, the printer will not receive faxes even if you have set it to receive faxes automatically.



## Receiving a fax manually

1 Turn off Auto Answer:



- a From the printer control panel, press .
- b Press the arrow buttons to scroll to **Fax Setup**, and then press **OK**.
- c Press the arrow buttons to scroll to **Ringing and Answering**, and then press **OK**.

- d Press **OK** again to select **Auto Answer**.
- e Press the arrow buttons to scroll to **Off**, and then press **OK**.

2 When the telephone rings and you hear fax tones when you pick up the handset, press  on the printer or **\*9\*** on the telephone attached to the printer.

**Warning—Potential Damage:** Do not touch the cables or the  and  ports while actively receiving a fax.

### Tips:

- The default code for answering faxes manually is **\*9\***, but for increased security, you can change it to a number that only you know. You can enter up to 7 characters for your code. The valid characters are the digits 0-9 and the characters # and \*.
- Make sure that the telephone is plugged into the  port on the back of the printer and that the printer is connected to the wall jack through the  port.

## Faxing FAQ

### If I skipped the fax setup initially, do I need to run the installer again to set up the fax?

You do not need to run the installer again. You can set up and configure the fax through the fax software that was installed with the printer software:

- 1 Connect the printer to the telephone line. For more information, see “Setting up the printer to fax” on page 65.
- 2 Configure the fax settings using the fax software. To access the fax software:

#### For Windows users

- a Click  or **Start**.
- b Click **All Programs** or **Programs**, and then select the printer program folder from the list.
- c Click **Printer Home** > **Fax** tab > **Set up the printer to fax**.
- d Run the Fax Setup Wizard. Make sure you select the correct telephone service and connection. The wizard configures optimal fax settings based on your connection.

#### For Macintosh users

- a From the Applications folder in the Finder, or from the Finder desktop, double-click the printer folder.
- b Double-click **Printer Settings** or **Fax Setup Utility**.
- c Configure the fax settings.

### What is a splitter and what type of splitter should I use?

If there are limited wall jacks in your home or limited ports on your adapter, then you can use a phone splitter. A splitter splits the telephone signal and allows you to connect multiple devices to the wall jack. It has two or more ports where you can plug the devices. Do *not* use a line splitter.

To make sure that you are using the correct splitter, plug an analog telephone into the splitter and then listen for a dial tone.

## What is my fax number?

In most cases, your telephone number is also your fax number. If you subscribe to the Distinctive Ring Pattern Detection (DRPD) service offered by telephone companies, then your fax number is the number that you assigned to the printer. Make sure that you enter the correct distinctive ring pattern for that number in the fax software or in the Fax Setup menu of the printer control panel.

If you have more than one telephone line, then make sure that you enter the number for the line on which the printer is connected.

## What is my dialing prefix?

The dialing prefix is the number or series of numbers that you press before you can dial the actual fax number or telephone number. If the printer is in an office setting or in a private branch exchange, this can be a specific number that you need to press so you can make a call outside the office. This can also be a country code or an area code that you need to enter if you are sending faxes outside of town. This can be very useful if you frequently send faxes to the same country or area. When you set the dialing prefix in the utility, you do not need to press the number or series of numbers every time you dial the fax number or telephone number. The printer automatically inputs the prefix every time you dial.

You can enter up to 8 characters as your dialing prefix. The valid characters are the numbers 0-9 and the characters # and \*. If you are using the fax software to enter the dial prefix, then you may also include the characters period, comma, star, pound, plus, minus, and parenthesis.

## When do I need to set Auto Answer to On?

Set Auto Answer to On if you want the printer to receive faxes automatically.

If the printer is connected to the same telephone line with an answering machine, then you must set Auto Answer to On so that you can receive both your voice calls and your faxes. Make sure that the answering machine is set to pick up on fewer rings than the rings set in the printer. This lets the other devices pick up the voice calls first. If an incoming call is a fax, the printer can detect fax signals on the line and takes the call.

## How many rings should I set?

If the printer is sharing a line with an answering machine, then set the printer to pick up on the greater number of rings. Because you have only one line, there is no way of distinguishing a voice call from an incoming fax. You can set the number of rings so that the answering machine takes the voice calls and the printer takes the incoming faxes. If you set the other devices to pick up on fewer rings, then the devices pick up calls first, and your voice calls are received. If a call is a fax, then the printer can detect it and will take over the call.

If the printer is on a dedicated fax line, then you may set the printer to pick up on any number of rings that you want.

## How do I set the distinctive ring for the printer?

Setting the correct ring is important if you subscribe to the Distinctive Ring Pattern Detection (DRPD) feature offered by telephone companies. This feature allows you to have multiple telephone numbers on one telephone line. Each telephone number has a designated ring pattern (a single ring, a double ring, a triple ring). The different ring patterns let you know what telephone number was dialed, and what device you should use to answer the call.

Assign one of your telephone numbers to the printer as the fax number, and then set the printer to answer the ring pattern of that number. If the pattern is set incorrectly, then the printer rings, but it never receives the fax.

To set the ring pattern in the printer:

- 1 From the printer control panel, press .
- 2 Press the arrow buttons to scroll to **Fax Setup**, and then press **OK**.
- 3 Press the arrow buttons to scroll to **Ringing and Answering**, and then press **OK**.
- 4 Press the arrow buttons to scroll to **Ring Pattern**, and then press **OK**.
- 5 Press the arrow buttons to select the ring pattern for the printer, and then press **OK**.

Distinctive Ring is also called Ident-a-Call, Smart Ring, Teen Ring, RingMaster, and IdentaRing.

## How can I check the dial tone?

A dial tone lets you know if the telephone line is working or if the printer is properly connected to the telephone line. If you encounter problems sending and receiving faxes, then make sure you can hear a dial tone on the line and through the printer.



### Make sure the telephone line and the wall jack are working

- 1 Plug an analog telephone into the wall jack.
- 2 Listen for a dial tone through the telephone handset.

If you hear a dial tone, then the telephone line and the wall jack are working.

If you do not hear a dial tone, plug the analog telephone into a second wall jack, and then listen for a dial tone. If you hear a dial tone, then the telephone line is working but the first wall jack is not working.

### Make sure the printer is connected properly to the telephone line

- 1 While the printer is connected to a telephone line through the  port on the back of the printer, plug an analog telephone into the  port of the printer.
- 2 Listen for a dial tone.

If you hear a dial tone, then the telephone line is working and properly connected to the printer.

If you do not hear a dial tone through both the wall jack and the printer, then see the “Fax troubleshooting checklist” on page 131.

## How do I adjust the speaker volume on the printer?

Listen to the dial tone to check if the telephone line is working and to check if the cables and devices are connected properly in your telephone network. Make sure that the dialing volume is not set to Off, especially if you are dialing a number on hook. If you set the printer to receive faxes manually, then make sure that you set the ringer volume loud enough for you to hear it.

### Adjusting the dialing volume

- 1 From the printer control panel, press .
- 2 Press the arrow buttons to scroll to **Fax Setup**, and then press **OK**.
- 3 Press the arrow buttons to scroll to **Dialing and Sending**, and then press **OK**.
- 4 Press the arrow buttons to scroll to **Dial Volume**, and then press **OK**.
- 5 Press the arrow buttons to select a dial volume setting, and then press **OK**.

### Adjusting the ringer volume

- 1 Press  to scroll back to the Fax Setup menu.
- 2 Press the arrow buttons to scroll to **Ringling and Answering**, and then press **OK**.
- 3 Press the arrow buttons to scroll to **Ringer Volume**, and then press **OK**.
- 4 Press the arrow buttons to select a ringer volume setting, and then press **OK**.

## How can I make sure that fax calls go to the printer and voice calls go to the answering machine?

To make sure the printer picks up incoming faxes, set Auto Answer to On, and then set the printer to pick up after a greater number of rings than the answering machine. For example, if the answering machine picks up calls after four rings, then set the printer to pick up after six rings. This way, the answering machine picks up calls first and your voice calls are received. If the call is a fax, then the printer detects the fax signal on the line and takes over the call.

## What settings work best with digital voice mail?

Voice mail and fax can share the same telephone line if you subscribe to a distinctive ring service. This feature allows you to have multiple telephone numbers on one telephone line. Each telephone number has a designated ring pattern (a single ring, a double ring, a triple ring). The different ring patterns let you know which telephone number was dialed, and which device you should use to answer the call.

If you do not have distinctive ring service, then set the printer to receive faxes manually (Auto Answer Off). This setting lets you receive both voice calls and fax calls, but works best if you use voice mail more often. You need to turn off voice mail whenever you are expecting a fax.

## How do I change the resolution of the documents that I fax?



The resolution, or fax quality, of the documents that you send may affect fax transmission. The receiving fax machine may not support high resolutions and may not be able to receive your fax. You can fix this by enabling Auto Fax Conversion, but the automatic conversion may result in an unreadable fax, especially if the original document is already blurred.

Choose a fax quality that best suits the capacity of the receiving fax machine and the quality of the original document.

Quality	Black resolution	Color resolution
Standard	200 x 100	200 x 200
Fine	200 x 200	200 x 200
Superfine	300 x 300	200 x 200
Ultrafine	300 x 300 (half-toned)	200 x 200

When sending a fax, after entering the fax number, press the arrow buttons to select a fax quality, and then press **OK**.

## How do I send a fax at a scheduled time?

- 1 From the printer control panel, press .
- 2 Enter or select a fax recipient:
  - Enter a fax number, and then press **OK**.
  - Press **Address Book** to select a number from the Speed Dial or Group Dial list, and then press **OK** twice.
- 3 If you want to send a fax to a group of recipients (broadcast fax), press the arrow buttons to scroll to **Yes**, and then press **OK**.  
Enter another number or select from the address book.  
Repeat the step to add more recipients.
- 4 Press **OK** to scroll to **Schedule Fax**.
- 5 Press the arrow buttons to scroll to **Send Later**, and then press **OK**.
- 6 Enter the time you want to send the fax, and then press **OK**.
- 7 If the printer is not set to the 24-hour mode, press the arrow buttons to select **AM** or **PM**, and then press **OK**.
- 8 Press  to start scanning the document and save the scheduled fax.  
The printer sends the fax at the designated time. Do *not* turn off the printer or unplug it from the telephone line before the scheduled time.
- 9 If you want to include another page in the fax, press the arrow buttons to scroll to **Yes**, and then press **OK**.

## How do I send a fax using a phone calling card?

- 1 Press **Dialtone**.  
You should hear the dial tone of the telephone line.
- 2 Enter the calling card information, and then when you are connected to the telephone carrier, follow the prompts.
- 3 When prompted, enter the fax number of the recipient, and then press .

## How do I know that the fax was sent successfully?

You can set the printer to print a confirmation page, or transmission report, every time you send a fax. This report includes the date and time that the fax was sent. If the fax job is unsuccessful, then the report also includes the cause of the error.

- 1 From the printer control panel, press .
- 2 Press the arrow buttons to scroll to **Fax Setup**, and then press **OK**.
- 3 Press the arrow buttons to scroll to **Reports**, and then press **OK**.
- 4 Press the arrow buttons to scroll to **Confirmation**, and then press **OK**.
- 5 Press the arrow buttons to select a report printing option:
  - If you want to print a report every time you send a fax, then select **For All** or **Print for All**.
  - If you want to save on ink and print a report only when a fax job is unsuccessful, then select **On Error**.
- 6 Press **OK**.

## How do I view the fax history of the printer?

You can print reports of sent and/or received faxes.

- 1 From the printer control panel, press .
- 2 Press the arrow buttons to scroll to **Fax Setup**, and then press **OK**.
- 3 Press the arrow buttons to scroll to **Reports**, and then press **OK**.
- 4 Press the arrow buttons to scroll to **Activity Report**, and then press **OK**.
- 5 To set when to print fax activity reports, press the arrow buttons to choose whether to print the fax activity reports after 40 faxes or on request only.
- 6 To print fax activity reports, press the arrow buttons to scroll to **Print Reports**, and then press **OK**.
  - To print sent fax history only, press the arrow buttons to scroll to **Send Log**, and then press **OK**.
  - To print received fax history only, press the arrow buttons to scroll to **Receive Log**, and then press **OK**.
  - To print sent and received fax history, press the arrow buttons to scroll to **Activity Report**, and then press **OK**.

## How do I forward a fax?

- 1 From the printer control panel, press .
- 2 Press the arrow buttons to scroll to **Fax Setup**, and then press **OK**.
- 3 Press the arrow buttons to scroll to **Ringing and Answering**, and then press **OK**.
- 4 Press the arrow buttons to scroll to **Fax Forward**, and then press **OK**.
- 5 Press the arrow buttons to scroll to **Forward** or **Print & Forward**, and then press **OK**.
- 6 Using the keypad, enter the number to which you want to forward the fax, and then press **OK**.

When you enable this option, all the faxes that you receive are automatically forwarded until you disable it.

To disable fax forwarding, return to the Fax Forward menu, and then select **Off**.

## Can I block faxes?

You can block faxes from specific numbers. You can also block junk faxes and faxes from unidentified senders (senders without a Caller ID). This feature is helpful if you want to receive faxes automatically but want to filter the faxes that you receive.

- 1** Turn on fax blocking.
  - a** From the printer control panel, press .
  - b** Press the arrow buttons to scroll to **Fax Setup**, and then press **OK**.
  - c** Press the arrow buttons to scroll to **Fax Blocking**, and then press **OK**.
  - d** Press the arrow buttons to scroll to **Turn On/Off**, and then press **OK**.
  - e** Press the arrow buttons to scroll to **On**, and then press **OK** to save the setting.
- 2** Add a number to block.
  - a** Press the arrow buttons to scroll to **Add**.
  - b** Press **OK**.
  - c** Use the keypad to enter the fax number, and then press **OK** to save.
  - d** Use the keypad to enter the name of the person that you want to block.
  - e** Repeat steps 2b through 2d until you have added all the numbers that you want to block. You can block up to 50 numbers.
- 3** Block unidentified faxes (faxes without a Caller ID number).
  - a** Press the arrow buttons to scroll to **Block No-ID**, and then press **OK**.
  - b** Press the arrow buttons to scroll to **On**, and then press **OK** to save the setting.

## Can I retrieve failed faxes?

The printer saves an incoming fax to the printer memory before it prints the fax. If the printer runs out of ink or runs out of paper, then you can print the fax later after resolving the error. The printer prompts you if there are faxes to be printed.

If an incoming fax or an outgoing fax fails due to power loss, then the printer automatically prints an error report the next time it is turned on. For incoming faxes, the error report lets you know who sent the fax and how many pages were not printed. For outgoing faxes, it lets you know how many pages were not sent. Faxes lost due to power loss are not retrievable.



# Networking

## Installing the printer on a wireless network

### Wireless network compatibility

Your printer contains an IEEE 802.11n wireless print server. Your printer is compatible with IEEE 802.11 b/g/n routers that are Wi-Fi certified.

### Supported network security options

The printer supports three wireless security options: no security, WEP, and WPA/WPA2.

#### No Security

It is not recommended to use no security at all on a home wireless network. Using no security means that anyone within range of your wireless network can use your network resources—including Internet access, if your wireless network is connected to the Internet. The range of your wireless network may extend far beyond the walls of your home, allowing access to your network from the street or from your neighbors' homes.

#### WEP

WEP (Wired Equivalent Privacy) is the most basic and the weakest type of wireless security. WEP security relies on a series of characters called the WEP key.

Every device on the wireless network must use the same WEP key. WEP security can be used on both ad hoc and infrastructure networks.

A valid WEP key has:

- Exactly 10 or 26 hexadecimal characters. Hexadecimal characters are A–F, a–f, and 0–9
- or*
- Exactly 5 or 13 ASCII characters. ASCII characters are letters, numbers, punctuation, and symbols found on a keyboard.

#### WPA/WPA2

WPA (Wi-Fi Protected Access) and WPA2 (Wi-Fi Protected Access 2) offer stronger wireless network security than WEP. WPA and WPA2 are similar types of security. WPA2 uses a more complex encryption method and is more secure than WPA. Both WPA and WPA2 use a series of characters, called the WPA pre-shared key or passphrase, to protect wireless networks from unauthorized access.

A valid WPA passphrase has:

- From 8 to 63 ASCII characters. ASCII characters in a WPA passphrase are case-sensitive.
- or*
- Exactly 64 hexadecimal characters. Hexadecimal characters are A–F, a–f, and 0–9.

Every device on the wireless network must use the same WPA passphrase. WPA security is an option only on infrastructure networks with wireless access points and network cards that support WPA. Most newer wireless network equipment also offers WPA2 security as an option.

**Note:** If your network uses WPA or WPA2 security, then select **WPA Personal** when you are prompted to select the type of security your network uses.

## Printing a network setup page

A *network setup page* lists the configuration settings of the printer, including the IP address and MAC address of the printer.

- 1 Load plain paper.
- 2 From the printer control panel, press .
- 3 Press the arrow buttons to scroll to **Network Setup**, and then press **OK**.
- 4 Press **OK** to select **Print Setup Page**.

The network setup page prints.

## Information you will need to set up the printer on a wireless network

To set up the printer for wireless printing, you need to know:

- The name of your wireless network. This is also known as the *Service Set Identifier* (SSID).
- If encryption was used to secure your network.
- The security key (either a WEP key or WPA passphrase) that allows other devices to communicate on the network if encryption was used to secure your network.

You can locate your network WEP key or WPA passphrase by accessing your wireless access point or router and checking the security information.

If your wireless access point (wireless router) is using *Wired Equivalent Privacy* (WEP) security, the WEP key should be:

- Exactly 10 or 26 hexadecimal characters. Hexadecimal characters are A–F, a–f, and 0–9.

*or*

- Exactly 5 or 13 ASCII characters. ASCII characters are letters, numbers, punctuation, and symbols found on a keyboard.

If your wireless access point is using *Wi-Fi Protected Access* (WPA) security, the WPA passphrase should be:

- From 8 to 63 ASCII characters. ASCII characters in a WPA passphrase are case-sensitive.

*or*

- Exactly 64 hexadecimal characters. Hexadecimal characters are A-F, a-f, and 0-9.

If your wireless network is not using security, then you will not have a security key.

**Note:** If you do not know the SSID of the network that your computer is connected to, launch the wireless utility of the computer network adapter and look for the network name. If you cannot find the SSID or the security information for your network, see the documentation that came with the wireless access point, or contact your system support person.

## Installing the printer on a wireless network

Before you install the printer on a wireless network, make sure that:

- Your wireless network is set up and working properly.
- The computer you are using is connected to the same wireless network where you want to set up the printer.

### For Windows users

**1** Close all open software programs.

**2** Insert the installation software CD.

If the Welcome screen does not appear after a minute, then launch the CD manually:

**a** Click , or click **Start** and then click **Run**.

**b** In the Start Search or Run box, type **D:\setup.exe**, where **D** is the letter of your CD or DVD drive.

**3** Follow the instructions on the Welcome screen to set up the printer.

### For Macintosh users

**1** Close all open software applications.

**2** Insert the installation software CD.

If the installation dialog does not appear after a minute, then click the CD icon on the desktop.

**3** Double-click **Install**.

**4** Follow the instructions on the installation dialog to set up the printer.

## Installing the printer on other computers

Once the printer is set up on the wireless network, it can be accessed wirelessly by any other computer on the network. However, you will need to install the printer driver on every computer that will access it. You do not need to configure the printer again, although you will need to run the setup software on each computer to install the driver.

### For Windows users

**1** Close all open software programs.

**2** Insert the installation software CD.

If the Welcome screen does not appear after a minute, then launch the CD manually:

**a** Click , or click **Start** and then click **Run**.

**b** In the Start Search or Run box, type **D:\setup.exe**, where **D** is the letter of your CD or DVD drive.

**3** Follow the instructions on the computer screen for installing a configured printer on a new computer.

### For Macintosh users

**1** Close all open software applications.

**2** Insert the installation software CD.

If the installation dialog does not appear after a minute, then click the CD icon on the desktop.

**3** Double-click **Install**.

- 4 Select **My printer is already set up. I am installing it on a new computer.**
- 5 Click **Continue**, and then follow the instructions on the computer screen for installing a configured printer on a new computer.

## Interpreting the colors of the Wi-Fi indicator light

The colors of the Wi-Fi indicator light show the network status of the printer.

- **Off** means one of the following:
  - The printer is turned off or is powering up.
  - The printer is not connected to a wireless network and is in Power Saver mode. In Power Saver mode, the power light pulses on and off.
- **Solid orange** means one of the following:
  - The printer has not yet been configured for a wireless network.
  - The printer is configured for an ad hoc connection, but it is not currently communicating with another ad hoc device.
- **Blinking orange** means one of the following:
  - The printer is out of the range of the wireless access point (wireless router).
  - The printer is trying to communicate with the wireless access point, but the wireless access point is turned off or not working properly.
  - Either the configured printer or the wireless access point has been turned off and back on, and the printer is trying to establish communications with the network.
  - The wireless settings of the printer may no longer be valid.
- **Green** means that the printer is connected to a wireless network and is ready for use.

## Special wireless installation instructions

The following instructions apply to customers outside of North America who are using a wireless broadband box. Some examples of these boxes include LiveBox, AliceBox, N9UF Box, FreeBox, and Club Internet.

### Before you begin

- Make sure your box is wireless-enabled and activated to work on a wireless network. For more information about configuring the box to work wirelessly, see the documentation that came with your box.
- Make sure your box is turned on and that your computer is on and connected to your wireless network.

### Adding the printer to your wireless network

- 1 Set up your printer for wireless networking using the setup instructions provided.  
Stop when you are prompted to select a network.
- 2 If there is an association/registration button on the back of your box, press it before selecting a network.  
**Note:** After pressing the association/registration button, you have five minutes to complete the printer installation.
- 3 Return to the computer screen.  
From the wireless networks list that appears, select your network, and then click **Continue**.

If your wireless network does not appear in the list:

- a Connect to another wireless network.

#### **For Windows users**

Click **Unlisted Network**.

#### **For Macintosh users**

Select **Other Wireless Network**, and then click **Continue**.

- b Enter the details about your wireless network.

**Note:** Your WEP, WPA, or WPA2 key may be obtained from the bottom of the box, the user's guide that came with the box, or from the box Web page. If you have already changed the key for your wireless network, use the key you created.

- 4 Follow the instructions on your screen to complete installation.

## **Assigning a static IP address**

The printer will be assigned an IP address automatically through DHCP on most wireless networks.

- 1 Complete the wireless setup, allowing the printer to receive a DHCP address from a DHCP server on the network.
- 2 Print a network setup page to see what IP address is currently assigned to the printer.
- 3 Open a Web browser and then type the printer IP address in the address field. Press **Enter**.

The printer Web page loads.

**Note:** If you are using a proxy server, then temporarily disable it to load the printer Web page correctly.

- 4 Click the **Configuration** link.
- 5 Click the **TCP/IP** link.
- 6 Click the **Set static IP address** link.
- 7 Type the IP address you want to assign to the printer in the **IP Address** field.
- 8 Click the **Submit** button.

The Submitting selection message appears.

To confirm that the address was successfully assigned, type the static IP address in the Web browser address field and then press **Enter**. The printer Web page loads if the address was successfully assigned.

For more information, contact your system support person.

## **Changing wireless settings after installation**

To change wireless settings on the printer, such as the configured network and the security key, do the following:

#### **For Windows users**

- 1 Click  or **Start**.
- 2 Click **All Programs** or **Programs**, and then select the printer program folder from the list.

- 3 Navigate to:  
**Printer Home** > select your printer > **Settings** tab > **Wireless setup utility**
- 4 Follow the instructions on the computer screen.

### For Macintosh users

- 1 From the Applications folder in the Finder, or from the Finder desktop, double-click the printer folder.
- 2 Double-click **Wireless Setup Assistant**.
- 3 Follow the instructions on the computer screen.

## Advanced wireless setup

### Creating an ad hoc wireless network

You can set up an ad hoc network if you:

- Do not have an access point or wireless router
- Do not have a wireless network (but do have a wireless network adapter for your computer)
- Want to set up a standalone network between the printer and a computer with a wireless network adapter

#### Notes:

- Before you begin, make sure your wireless network adapter is properly attached to your computer and is working.
- The recommended way to set up your wireless network is to use an access point (wireless router). This network setup is called *infrastructure network*.
- If your computer has *MyWi-Fi* or *Wi-Fi Direct*, then you can create direct connections to your wireless printer. For more information, see the documentation that came with your computer.
- The printer can communicate on only one wireless network at a time. Configuring the printer for an ad hoc wireless network will keep it from working on any other wireless network, either ad hoc or infrastructure.

### In Windows Vista or later

- 1 Click  > **Control Panel** > **Network and Internet** > **Network and Sharing Center**.
- 2 Click **Set up a connection or network** > **Set up a wireless ad-hoc (computer-to-computer) network** > **Next**.
- 3 Follow the instructions for setting up a wireless ad hoc network. As part of the setup:
  - a Create a network name or SSID for the network between the computer and your printer.
  - b Write down the name of your network. Make sure you copy it exactly, including any capital letters.
  - c Go to the Security Type list, select **WPA2-Personal** or **WEP**, and then create a WPA passphrase or WEP key.

WPA passphrases must be:

- From 8 to 63 ASCII characters. ASCII characters are letters, numbers, and symbols found on a keyboard. ASCII characters in a WPA passphrase are case-sensitive.  
*or*
- Exactly 64 hexadecimal characters. Hexadecimal characters are A–F, a–f, and 0–9.

WEP keys must be:

- Exactly 5 or 13 ASCII characters. ASCII characters are letters, numbers, and symbols found on a keyboard.  
*or*
- Exactly 10 or 26 hexadecimal characters. Hexadecimal characters are A–F, a–f, and 0–9.

**d** Write down the password for your network. Make sure you copy it exactly, including any capital letters.

Windows Vista will enable the ad hoc network for you. It will appear in the “Connect to a network” dialog under “Available networks,” indicating that the computer is configured for the ad hoc network.

**4** Close the Windows Control Panel and any remaining windows.

**5** Insert the installation software CD, and follow the directions for wireless installation.

**Note:** Do not connect the installation or network cables until instructed to do so by the setup software.

**6** When the available networks are displayed, provide the network name and the security information you created. The installer will configure the printer for use with your computer.

**7** Store a copy of your network name and security information in a safe place for future reference.

**Note:** You may need to reconnect Windows Vista computers to the ad hoc network after restarting.

## In Windows XP

**1** Click **Start > Control Panel > Network and Internet Connections > Network Connections**.

**2** Right-click the icon for your wireless network connection.

**3** Click **Enable**, if it appears in the pop-up menu.

**Note:** If Disable appears, then your wireless connection is already enabled.

**4** Right-click the **Wireless Network Connection** icon.

**5** Click **Properties > Wireless Networks** tab.

**Note:** If the Wireless Networks tab does not appear, then your computer has third-party software that controls your wireless settings. You must use that software to set up the ad hoc wireless network. For more information, see the documentation for the third-party software.

**6** Select the **Use Windows to configure my wireless network settings** check box.

**7** Under Preferred Networks, delete any existing networks.

Select a network, and then click **Remove** to delete the network from the list.

**8** Click **Add** to create an ad hoc network.

**9** In the Network Name (SSID) box, type the name you want to give your wireless network.

**10** Write down the network name you chose so you can refer to it when running the wireless setup. Make sure you copy it exactly, including any capital letters.

**11** If Network Authentication appears in the list, then select **Open**.

**12** In the “Data encryption” list, select **WEP**.

**13** If necessary, clear the “The key is provided for me automatically” check box.

**14** In the Network Key box, type in a WEP key.

- 15 Write down the WEP key you chose so you can refer to it when running the wireless setup. Make sure you copy it exactly, including any capital letters.
- 16 In the “Confirm network key” box, type the same WEP key.
- 17 Select **This is a computer-to-computer (ad hoc) network; wireless access points are not used.**
- 18 Click **OK** twice to close the two open windows.
- 19 It may take a few minutes for your computer to recognize the new settings. To check the status of your network:
  - a Right-click the **Wireless Network Connections** icon.
  - b Select **View Available Wireless Networks**.
    - If the network is listed but the computer is not connected, select the ad hoc network, and then click **Connect**.
    - If the network does not appear, wait a moment, and then click **Refresh network list**.
- 20 Insert the installation software CD, and then follow the directions for wireless installation.

**Note:** Do *not* connect the installation or network cables until instructed to do so by the setup software.
- 21 When the available networks are displayed, provide the network name and the security information you created. The installer will configure the printer for use with your computer.
- 22 Store a copy of your network name and security information in a safe place for future reference.

## In Windows 2000

- Refer to the documentation that came with your wireless network adapter for information on configuring an ad hoc network with Windows 2000.

## For Macintosh users

- 1 Access the Airport settings:

### In Mac OS X version 10.5 or later

From the Apple menu, navigate to:

**System Preferences > Network > AirPort**

### In Mac OS X version 10.4 or earlier

From the Finder, navigate to:

**Applications > Internet Connect > AirPort**

- 2 From the Network Name or Network menu, click **Create Network**.
- 3 Create a name for the ad hoc network, and then click **OK**.

**Note:** Store the network name and password in a safe place for future reference.



## Adding a printer to an existing ad hoc wireless network

**Note:** The printer can communicate on only one wireless network at a time. Configuring the printer for an ad hoc wireless network will remove it from any other wireless network, either ad hoc or infrastructure, for which it is configured.

### For Windows users

- 1 Click  or **Start**.
- 2 Click **All Programs** or **Programs**, and then select the printer program folder from the list.
- 3 Navigate to:  
**Printer Home** > select your printer > **Settings** tab > **Wireless setup utility**
- 4 Follow the instructions on the computer screen.

**Note:** Windows Vista computers may need to be reconnected to the ad hoc network after restarting.

### For Macintosh users

- 1 From the Applications folder in the Finder, or from the Finder desktop, double-click the printer folder.
- 2 Double-click **Wireless Setup Assistant**.
- 3 Follow the instructions on the computer screen.

## Configuring the printer wirelessly using WPS (Wi-Fi Protected Setup)

*Wi-Fi Protected Setup (WPS)* is a method of configuring computers and printers on a secure wireless network. WPS is faster than manual configuration, and it reduces typing errors when new devices are added to a wireless network. The SSID and WPA passphrase are automatically detected and configured for you. The printer supports WPS and can be configured for wireless access using WPS. In order to use WPS to configure the printer, the wireless router must also support WPS.

If you want to use WPS to set up your printer, then insert the CD and follow the instructions on the computer screen.

### Notes:

- To use WPS to configure the printer wirelessly, all of the devices on your wireless network must support WPS. If any device on your network does not support WPS, then you must type the SSID and security information when prompted.
- If you are using the PIN method to add your printer using WPS, make sure you type all eight digits when you are asked to enter your PIN.

## Switching between USB and wireless connections (Windows only)

You can change the way you access your printer, depending on your needs. The following procedures assume that you have configured your printer for one type of connection and that the printer drivers are installed on the computer. See related topics on troubleshooting specific connection types if you encounter difficulties during configuration.

## Using the printer wirelessly

- 1 Click  or **Start**.
- 2 Click **All Programs** or **Programs**, and then select the printer program folder from the list.
- 3 Select **Printer Home**.
- 4 Click the **Settings** tab.
- 5 Click the **Wireless setup utility** link.
- 6 Follow the instructions on the computer screen to set up the printer wirelessly.

**Note:** There is no need to remove the USB cable connecting the printer to the computer during wireless configuration.

## Using the printer locally (USB)

- 1 Attach a USB cable to the computer and to the printer.
- 2 Wait a moment for Windows to locate the driver and finish setting up the printer.

**Note:** You can continue to use the printer wirelessly.

## Switching between USB and wireless connections (Macintosh only)

You can change the way you access your printer depending on your needs. The procedures below assume that you have configured your printer for one type of connection. See related topics on troubleshooting-specific connection types if you encounter difficulties during configuration.

### Switching to a wireless connection

- 1 Close all open applications.
- 2 Insert the installation software CD.  
If the installation dialog does not appear after a minute, then click the CD icon on the desktop.
- 3 Double-click **Lexmark Extras > Lexmark Setup Assistant**.
- 4 Follow the instructions on the computer screen for configuring the printer wirelessly.

**Note:** There is no need to remove the USB cable connecting the printer to the computer during wireless configuration.

### Switching to a local (USB) connection

- 1 Attach one end of a USB cable to the USB port on the back of the printer. Attach the other end to a USB port on the computer.
- 2 Add the printer:

#### In Mac OS X version 10.5 to 10.6

- a From the Apple menu, navigate to:  
**System Preferences > Print & Fax > + > Default tab > select your printer**

**Note:** Choose the printer that corresponds with your selected connection type (*Bonjour* or *USB*).

- b Click **Add**.

### In Mac OS X version 10.4 or earlier

- a From the Finder, choose **Utilities**.
  - b Double-click **Printer Setup Utility** or **Print Center**.
  - c From the Printer List dialog, choose the printer you want to use, and then click **Add**.
  - d From the Printer Browser, select your printer, and then click **Add**.
- 3 A second print queue will be created. Remove the wireless queue if you do not want to switch back to accessing the printer over a wireless connection.

## Sharing a printer in a Windows environment

- 1 Prepare the computers to share the printer:
  - a Make all computers printing to the printer accessible through Network Neighborhood by enabling File and Print Sharing. See the Windows documentation for instructions on enabling File and Print Sharing.
  - b Install the printer software on all computers that will print to the printer.
- 2 Identify the printer:
  - a On the computer that is attached to the printer, do one of the following:
    - 1 Click , or click **Start** and then click **Run**.
    - 2 In the Start Search or Run box, type **control printers**.
    - 3 Press **Enter**, or click **OK**.  
The printer folder opens.
  - b Right-click the name of your printer.
  - c Click **Sharing** or **Printer Properties**.
  - d From the Sharing tab, select **Share this printer** or **Shared as**, and then assign a distinctive name.
  - e Click **OK**.
- 3 Locate the printer from the remote computer:

**Note:** The remote computer is the one that is not attached to the printer.

  - a Do one of the following:
    - 1 Click , or click **Start** and then click **Run**.
    - 2 In the Start Search or Run box, type **control printers**.
    - 3 Press **Enter**, or click **OK**.  
The printer folder opens.
  - b Right-click the name of your printer.
  - c Click **Properties** or **Printer properties**.
  - d Click the **Ports** tab, and then click **Add Port**.
  - e Select **Local Port**, and then click **New Port**.
  - f Type the **Universal Naming Convention (UNC) Port name**, which consists of the server name and the distinctive printer name that was specified in step 2 on page 99. The name should be in the form `\\server\printer`.
  - g Click **OK**.
  - h Click **Close** on the Printer Ports dialog.

- i Make sure the new port is selected on the Ports tab, and then click **Apply**.  
The new port is listed with the printer name.
- j Click **OK**.

## Sharing a printer in a Macintosh environment

- 1 From the Apple menu, choose **System Preferences**.
- 2 From the menu bar, click **Help → System Preferences Help**.
- 3 In the Search field, type **sharing the printer on a network**, and then press **return**.
- 4 To let other Macintosh computers on the network that use Mac OS X version 10.3 or later use any printer connected to your Macintosh computer, double-click **Sharing your printer with Mac OS X users**.  
*or*  
To let Windows computers on the network use any printer connected to your Macintosh computer, double-click **Sharing your printers with Windows users**.
- 5 Follow the instructions on the computer screen.

**Note:** Windows users should see the Windows documentation for information on adding a network printer connected to a Macintosh computer.

## Networking FAQ

### What is Wi-Fi Protected Setup?

Wi-Fi Protected Setup (WPS) is a simple and secure configuration that allows you to establish a wireless home network and enable network security without requiring prior knowledge of Wi-Fi technology. It is no longer necessary to configure the network name (SSID) and WEP key or WPA passphrase for network devices.

**Note:** WPS only supports networks that communicate through wireless access points (wireless routers).

The printer supports the following methods in connecting to a wireless network:

- *Personal Identification Number (PIN)*—A PIN on the printer is entered into the wireless settings of the wireless access point.
- *Push Button Configuration (PBC)*—Buttons on both the printer and the wireless access point are pushed within a given period of time.

Look for any of these identifier marks to check if your wireless access point is WPS certified:



You can find these WPS logos on the side, back, or top of your wireless access point.

For more information on accessing the wireless settings and determining the WPS capability of your wireless access point, see the documentation that came with the wireless access point or contact your system support person.

## **Where do I find my WEP key or WPA passphrase?**

To find the WEP key or WPA passphrase for the wireless network, view the security settings on the access point or wireless router. Most access points have a Web page that can be accessed using a Web browser.

You can also check the manual that came with your access point or router. If your access point or router is using the default settings, you can find the information in the manual. If someone else set up your network for you, that person or company may have included the information in the manual.

If you do not know how to access the Web page, or if you do not have administrator access to the wireless access point on your network, and are unable to locate the information in the manual, contact your system support person.

## **What is an SSID?**

A Service Set Identifier (SSID) is the name that identifies a wireless network. All devices on the network must know the SSID of the wireless network or they will not be able to communicate with each other. Usually, the wireless network broadcasts the SSID to allow wireless devices in the area to connect to it. Sometimes, the SSID is not broadcast for security reasons.

If the SSID of your wireless network is not broadcast, it cannot be detected automatically and will not show up in the list of available wireless networks. You must enter the network information manually in this situation.

An SSID can contain up to 32 alphanumeric characters.

## **Where do I find my SSID?**

You can find the SSID for the wireless network by viewing the settings on the access point or wireless router. Most access points have a built-in Web server that can be accessed using a Web browser.

Many network adapters provide a software application that allows you to view the wireless settings of your computer, including your SSID. Check your computer to see if a program was installed with your network adapter.

If you are unable to locate your SSID using either of these methods, contact your system support person.

## **What is a network?**

A network is a collection of devices such as computers, printers, Ethernet hubs, wireless access points, and routers connected together for communication through cables or through a wireless connection. A network can be wired, wireless, or designed to have both wired and wireless devices.

Devices on a wired network use cables to communicate with each other.

Devices on a wireless network use radio waves instead of cables to communicate with each other. For a device to be able to communicate wirelessly, it must have a wireless network adapter attached or installed that lets it receive and transmit radio waves.

## How do I find out what type of security my network is using?

You must know the WEP key or WPA passphrase and the type of security (WEP, WPA, or WPA2) used on the wireless network. To obtain this information, see the documentation that came with your wireless access point (wireless router), see the Web page associated with the wireless access point, or consult your system support person.

**Note:** The WEP key or WPA passphrase is not the same as the password for the wireless access point. The password allows you to access the wireless access point settings. The WEP key or WPA passphrase allows printers and computers to join your wireless network.

## How are home networks configured?

For desktop computers, laptops, and printers to communicate with each other over a network, they must be connected by cables and/or have wireless network adapters built in or installed in them.

There are many different ways a network can be set up. Four common examples appear below.

**Note:** The printers in the following diagrams represent printers with internal print servers built into them so that they can communicate over a network.

### Wireless network examples

#### Scenario 1: Mixed wired and wireless connections on a network with Internet access

- All computers and printers connect to the network through a router with Ethernet and wireless capabilities.
- Some computers and printers connect wirelessly to the router; others connect over a wired connection.
- The network is connected to the Internet through a DSL or cable modem.

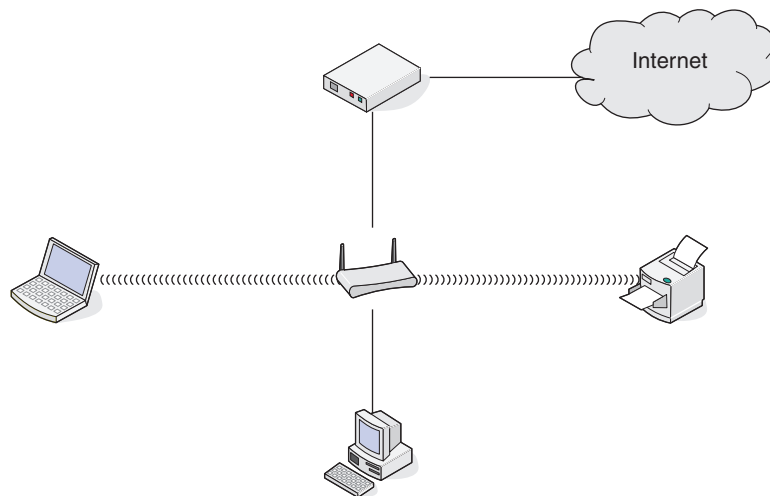

### Scenario 2: Wireless network with Internet access

- All computers and printers connect to the network using a wireless access point or wireless router.
- The wireless access point connects the network to the Internet through a DSL or cable modem.

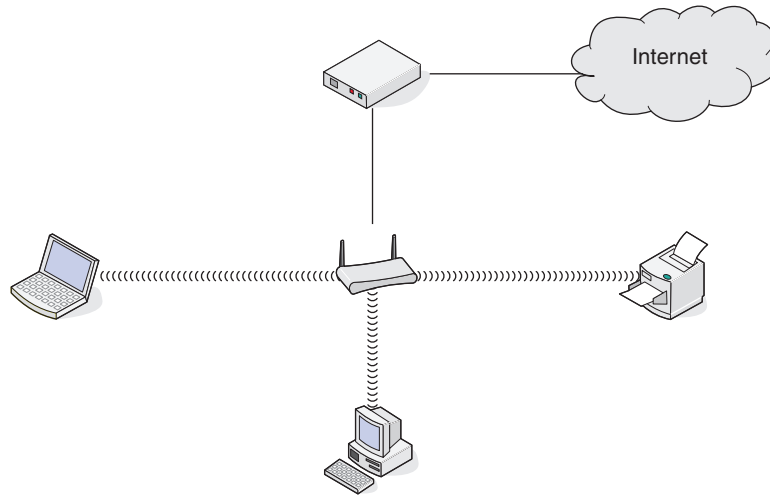

### Scenario 3: Wireless network with no Internet access

- Computers and printers connect to the network using a wireless access point.
- The network has no connection to the Internet.

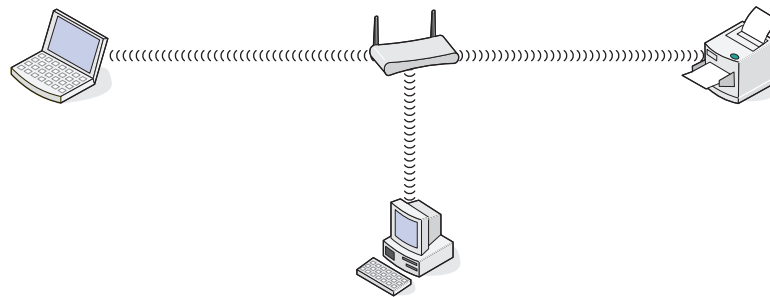

### Scenario 4: Computer connected wirelessly to a printer without Internet access

- A computer is directly connected to a printer without going through a wireless router.
- This configuration is referred to as an *ad hoc network*.
- The network has no connection to the Internet.

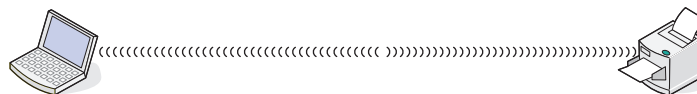

**Note:** Most computers can connect to only one wireless network at a time. If you access the Internet over a wireless connection, you will lose Internet access if you are connected to an ad hoc network.

## Why do I need an installation cable?

When setting up the printer on your wireless network, the printer will need to temporarily connect to a computer using the installation cable. This temporary connection is used to set up the wireless settings of the printer.

The installation cable connects to a rectangular USB port on the installing computer and the square USB port on the printer.

## How do I attach the installation cable?

The installation cable attaches to a USB port on the computer and to the square connector on the back of the printer. This connection allows you to configure the printer for a networked or locally attached installation.

- 1 Attach the large, rectangular connector to any USB port on your computer. USB ports may be on the front or the back of the computer, and may be horizontal or vertical.

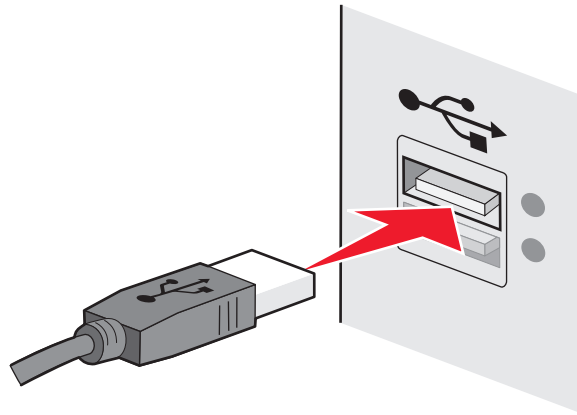

- 2 Attach the small, square connector to the printer.

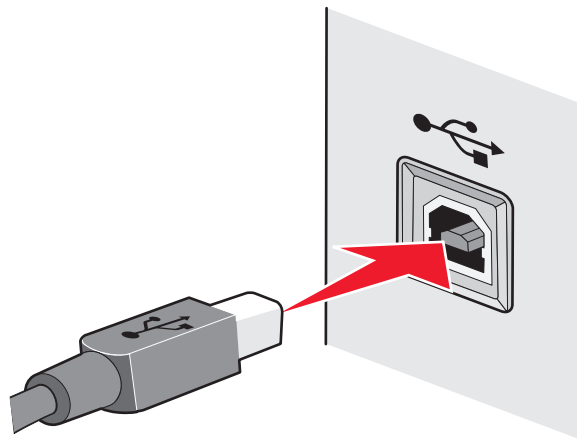

- 3 Continue following the on-screen instructions.

## How are infrastructure and ad hoc networks different?

Wireless networks can operate in one of two modes: infrastructure or ad hoc.

In *infrastructure* mode, all devices on a wireless network communicate with each other through a wireless router (wireless access point). Devices on the wireless network must have valid IP addresses for the current network and share the same SSID and channel as the wireless access point.

In *ad hoc* mode, a computer with a wireless network adapter communicates directly with a printer equipped with a wireless print server. The computer must have a valid IP address for the current network and be set to ad hoc mode. The wireless print server must be configured to use the same SSID and channel that the computer is using.



The following table compares the characteristics and requirements of the two types of wireless networks.

	Infrastructure	Ad hoc
<b>Characteristics</b>		
Communication	Through wireless access point	Directly between devices
Security	More security options	WEP or no security
Range	Determined by range and number of wireless access points	Restricted to range of individual devices on network
Speed	Usually faster	Usually slower
<b>Requirements for all devices</b>		
Unique IP address for each device	Yes	Yes
Mode set to	Infrastructure mode	Ad hoc mode
Same SSID	Yes, including the wireless access point	Yes
Same channel	Yes, including the wireless access point	Yes

We recommend setting up a network in infrastructure mode using the installation CD that came with the printer.

Infrastructure mode is the recommended setup method because it provides:

- Increased network security
- Increased reliability
- Faster performance
- Easier setup

## Finding the signal strength

Wireless devices have built-in antennas that transmit and receive radio signals. The signal strength listed on the printer network setup page indicates how strongly a transmitted signal is being received. Many factors can affect the signal strength. One factor is interference from other wireless devices or other devices such as microwave ovens. Another factor is distance. The farther two wireless devices are from each other, the more likely it is that the communication signal will be weaker.

The strength of the signal received by your computer can also affect the connectivity of the printer with the network during configuration. When you installed the wireless adapter in your computer, the adapter software probably placed an icon in your system tray. Try double-clicking this icon, and it will tell you how strongly the computer is receiving the wireless signal from the network.

To improve signal quality, remove sources of interference and/or move wireless devices closer to the wireless access point (wireless router).

## How can I improve wireless signal strength?

A common reason wireless printers fail to communicate over a network is poor wireless signal quality. If the signal is too weak, too distorted, or blocked by an object, it cannot carry information between the access point and the printer. To determine if the printer is receiving a strong signal from the access point, print a network setup page. The Quality field indicates the relative strength of the wireless signal the printer is receiving. Drops in signal strength can be intermittent, however, and although the signal quality appears high, it may drop during certain conditions.

If you think signal strength is a problem between your access point and the printer, try one or more of the following:

### Notes:

- The solutions below are for infrastructure networks. If you are using an ad hoc network, adjust the computer when the solution suggests adjusting the access point.
- Ad hoc networks have a much shorter range than infrastructure networks. Try moving the printer closer to the computer if they seem to have trouble communicating.

### MOVE THE PRINTER CLOSER TO THE WIRELESS ACCESS POINT/WIRELESS ROUTER

If the printer is too far away from the access point, it will not be able to communicate with other devices on the network. For most indoor wireless networks, the maximum distance between the access point and the printer is approximately 100 feet (30 meters). This distance could be longer or shorter, depending upon the layout of the network and the limitations of the access point.

### REMOVE OBSTACLES BETWEEN THE ACCESS POINT AND THE PRINTER

The wireless signal from your access point will pass through most objects. Most walls, floors, furniture and other objects will not block the wireless signal. However, there are materials that are too dense for the signal to pass through. Objects containing metal and concrete can block the signal. Arrange your printer and access point so that the signal is not blocked by such objects.

### REMOVE SOURCES OF INTERFERENCE

Other types of radio frequencies can cause problems with the wireless signal on your network. These sources of interference can cause printing issues that seem to come and go. Turn off potential sources of interference where possible. Avoid using microwaves and cordless phones when printing over your wireless network.

If another wireless network is operating in the vicinity, change the wireless channel on the access point.

Do not place your access point on a printer or other electronic device. Such devices can also interfere with the wireless signal.

### ARRANGE THE NETWORK TO REDUCE SIGNAL ABSORPTION

Even when the wireless signal is able to pass through an object, it is slightly weakened. If it passes through too many objects, it can be significantly weakened. All objects absorb part of the wireless signal when it passes through them, and certain types of objects absorb enough to cause communications problems. Place your access point as high in the room as possible to avoid signal absorption.

## How can I make sure my computer and printer are connected to the same wireless network?

If the printer is not on the same wireless network as the computer, then you will not be able to print wirelessly. The SSID of the printer must match the SSID of the computer, if the computer is already connected to the wireless network.

### For Windows users

**1** Obtain the SSID of the network that the computer is connected to:

**a** Type the IP address of your access point (wireless router) in the address field of your Web browser.

If you do not know the IP address of the access point:

**1** Click , or click **Start** and then click **Run**.

**2** In the Start Search or Run box, type **cmd**.

**3** Press **Enter**, or click **OK**.

**4** Type **ipconfig**, and then press **Enter**. Check the Wireless Network Connection section:

- The “Default Gateway” entry is typically the access point.
- The IP address appears as four sets of numbers separated by periods, such as 192.168.2.134.

**b** Type the user name and password of the router when prompted.

**c** Click **OK**.

**d** In the Wireless settings section, look for the SSID.

**e** Write down the SSID.

**Note:** Make sure you copy it exactly, including any capital letters.

**2** Obtain the SSID of the network that the printer is connected to:

**a** From the printer, print a network setup page.

**b** In the Wireless section, look for **SSID**.

**3** Compare the SSID of the computer and SSID of the printer.

If the SSIDs are the same, then the computer and the printer are connected to the same wireless network.

If the SSIDs are not the same, then run the utility again to set up the printer on the wireless network used by the computer.

### For Macintosh users with an AirPort base station

#### In Mac OS X version 10.5 or later

**1** From the Apple menu, navigate to:

**System Preferences > Network > AirPort**

The SSID of the network that the computer is connected to is displayed in the Network Name menu.

**2** Write down the SSID.

## In Mac OS X version 10.4 or earlier

1 From the Finder, navigate to:

**Applications > Internet Connect > AirPort**

The SSID of the network that the computer is connected to is displayed in the Network menu.

2 Write down the SSID.

## For Macintosh users with an access point

1 Type the IP address of the access point in the address field of your Web browser and continue to step 2.

If you do not know the IP address of the access point, then do the following:

a From the Apple menu, navigate to:

**System Preferences > Network > AirPort**

b Click **Advanced** or **Configure**.

c Click **TCP/IP**.

The Router entry is typically the access point.

2 Type your user name and password when prompted, and then click **OK**.

3 In the Wireless settings section, look for the SSID.

4 Write down the SSID, security type, and the WEP key/WPA passphrase (if shown).

### Notes:

- Make sure you copy the network information down exactly, including any capital letters.
- Store the SSID and the WEP key or WPA passphrase in a safe place for future reference.

## Can I use my printer on a USB and a network connection at the same time?

Yes, the printer supports a simultaneous USB and network connection. The printer can be configured in the following ways:

- Locally attached (connected to a computer using a USB cable)
- Wireless network
- Wireless network and locally attached simultaneously

## What is a MAC address?

A Media Access Control (MAC) address is a 48-bit identifier associated with the hardware of network equipment. The MAC address may also be called the physical address because it is connected to the hardware of a device instead of its software. The MAC address is displayed as a hexadecimal number in this format: 01-23-45-67-89-AB.

Every device capable of communicating on a network has a MAC address. Network printers, computers, and routers, whether Ethernet or wireless, all have MAC addresses.

While it is possible to change the MAC address of a network device, it is not common practice to do so. For this reason, MAC addresses are considered permanent. IP addresses are easily changed, so MAC addresses are a more reliable method of identifying a specific device on a network.

Routers with security capabilities may allow filtering of MAC addresses on networks. This allows a managed list of devices to access the network, identified by their MAC addresses. MAC address filtering can help prevent access on the network from unwanted devices, such as from intruders on a wireless network. MAC address filtering can also prevent legitimate access if you forget to add a new device to the router's list of allowed addresses. If your network uses MAC address filtering, be sure to add the MAC address of the printer to the list of allowed devices.

## How do I find the MAC address?

Most network equipment has a unique hardware identification number to distinguish it from other devices on the network. This is called the *Media Access Control (MAC)* address.

When installing the printer on a network, make sure you select the printer with the correct MAC address.

The MAC address label is located inside the printer.

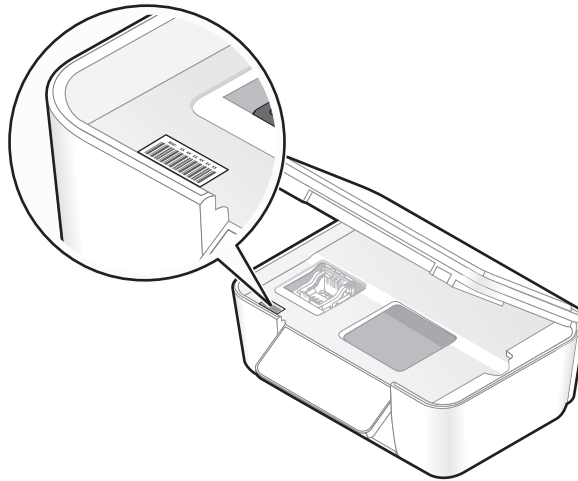

The MAC address of the internal print server is a series of letters and numbers. Other devices sometimes use a type of MAC address called *Universally Administered Address (UAA)*.



**Note:** A list of MAC addresses can be set on an access point (router) so that only devices with matching MAC addresses are allowed to operate on the network. This is called *MAC filtering*. If MAC filtering is enabled in your access point and you want to add a printer to your network, then the MAC address of the printer must be included in the MAC filter list.

## What is an IP address?

An IP address is a unique number used by devices (such as a wireless printer, computer, or wireless access point) on an IP network to locate and communicate with each other. Devices on an IP network can communicate with each other only if they have unique and valid IP addresses. A unique IP address means no two devices on the same network have the same IP address.

An IP address is a group of four numbers separated by periods. An example of an IP address is 192.168.100.110.

## What is TCP/IP?

Networks are able to function because computers, printers, and other devices are able to send data to each other, either through cables or by using wireless signals. This transfer of data is made possible by sets of data transmission rules called *protocols*. A protocol can be thought of as a language, and like a language, it has rules allowing participants to communicate with each other.

Different types of networks use different protocols, but *Transmission Control Protocol/Internet Protocol* (TCP/IP) is the most popular. TCP/IP is used to send data over the Internet as well as over most corporate and home networks.

Because computers do not understand words and instead rely upon numbers for communication, TCP/IP requires that every device on a network using TCP/IP to communicate must have an IP address. IP addresses are essentially unique computer names in a numeric format, used to transfer data around a network. IP addresses allow TCP/IP to confirm requests for and receipt of data by various devices on the network.

## How do I locate IP addresses?

### For Windows users

- 1 Click , or click **Start** and then click **Run**.
- 2 In the Start Search or Run box, type `cmd`.
- 3 Press **Enter**, or click **OK**.  
The Command Prompt window opens.
- 4 Type `ipconfig`, and then press **Enter**.  
The IP address appears as four sets of numbers separated by periods, such as 192.168.0.100.

### For Macintosh users

- 1 From the Apple menu, choose **About This Mac**.
- 2 Click **More Info**.
- 3 From the Contents pane, choose **Network**.
- 4 If you are connected over a wireless network, choose **AirPort** from the Active Services list.

## How to locate a printer IP address

- You can locate the printer IP address by viewing the printer network setup page.

## How are IP addresses assigned?

An IP address may be assigned automatically by the network using DHCP. Once the printer is set up on a computer, the computer sends all print jobs across the network to the printer using this address.

If the IP address is not automatically assigned, you will be asked during wireless setup to manually enter an address and other network information after selecting your printer from the available list.

## **What is a key index?**

A wireless access point (wireless router) can be configured with as many as four WEP keys. Only one key is used on the network at a time, however. The keys are numbered, and the number of a key is referred to as its key index. All devices on the wireless network must be configured to use the same key index when multiple WEP keys are configured on the wireless access point.

Select the same key index on your printer as you are using on your wireless access point.

# Maintaining the printer

## Maintaining ink cartridges

In addition to the following tasks that you can perform, your printer performs an automatic maintenance cycle every week if it is plugged into an electrical outlet. It will briefly come out of Power Saver mode or will temporarily turn on if it is turned off.

### Checking ink levels

#### Using the printer control panel

- 1 From the printer control panel, navigate to:  
 > **Maintenance** > **OK** > **OK**
- 2 Press the arrow buttons to check the ink level in each cartridge.

#### Using the printer software

##### For Windows users

- 1 Click  or **Start**.
- 2 Click **All Programs** or **Programs**, and then select the printer program folder from the list.
- 3 Navigate to:  
**Printer Home** > select your printer > **Maintenance** tab > **Check ink levels**

##### For Macintosh users

###### In Mac OS X version 10.6

- 1 From the Apple menu, navigate to:  
**System Preferences** > **Print & Fax** > select your printer
- 2 Click **Options & Supplies** or **Print Queue**.
- 3 Click **Supply Levels**.

###### In Mac OS X version 10.5 or earlier

- 1 From the Finder desktop, double-click the printer folder.
- 2 Double-click the **Printer Utility** icon.
- 3 Check the ink levels from the Maintenance tab.



## Aligning the printhead

If the characters or lines on your printer image appear jagged or wavy, then you may need to align the printhead.

### Using the printer control panel

- 1 Load plain paper.
- 2 From the home screen, navigate to:  
 > **Maintenance** > **OK** > **Align Printer** > **OK** > **OK**

An alignment page prints.

**Note:** Do not remove the alignment page until printing is finished.

### Using the printer software

#### For Windows users

- 1 Load plain paper.
- 2 Click  or **Start**.
- 3 Click **All Programs** or **Programs**, and then select the printer program folder from the list.
- 4 Navigate to:  
**Printer Home** > select your printer > **Maintenance** tab > **Align cartridges**
- 5 Follow the instructions on the computer screen.

#### For Macintosh users

**Note:** This feature is available only in Mac OS X version 10.5 or earlier.

- 1 Load plain, unmarked paper.
- 2 From the Finder desktop, double-click the printer folder.
- 3 Double-click the **Printer Utility** icon.
- 4 From the Maintenance tab, click **Print Alignment Page**.
- 5 Follow the instructions on the computer screen.

If you aligned the cartridges to improve print quality, then print your document again. If print quality has not improved, then clean the printhead nozzles.

## Cleaning the printhead nozzles

Poor print quality is sometimes due to clogged printhead nozzles. Clean the printhead nozzles to improve the quality of your prints.

### Notes:

- Cleaning the printhead nozzles uses ink, so clean them only when necessary.
- Deep cleaning uses more ink, so try the Clean Printhead option first to save ink.
- If the ink levels are too low, you must replace the ink cartridges before you can clean the printhead nozzles.

### Using the printer control panel

- 1 From the printer control panel, navigate to:

 > **Maintenance** > **OK**

- 2 Press the arrow buttons to scroll to **Clean Printhead** or **Deep Clean Printhead**, and then press **OK**.

- 3 Press **OK**.

A cleaning page prints.

### Using the printer software

#### For Windows users

- 1 Click  or **Start**.
- 2 Click **All Programs** or **Programs**, and then select the printer program folder from the list.
- 3 Navigate to:

**Printer Home** > **Maintenance** > **Clean cartridges**

A cleaning page prints.

#### For Macintosh users

**Note:** This feature is available only in Mac OS X version 10.5 or earlier.

- 1 Load plain paper.
- 2 From the Finder desktop, double-click the printer folder.
- 3 Double-click the **Printer Utility** icon.
- 4 From the Maintenance tab, select **Clean Print Nozzles**.

A cleaning page prints.

## Cleaning the exterior of the printer

- 1 Make sure that the printer is turned off and unplugged from the wall outlet.



**CAUTION—SHOCK HAZARD:** To avoid the risk of electric shock when cleaning the exterior of the printer, unplug the power cord from the wall outlet and disconnect all cables to the printer before proceeding.

- 2 Remove all paper from the printer.

**3** Dampen a clean, lint-free cloth with water.

**Warning—Potential Damage:** Do not use household cleaners or detergents, as they may damage the finish of the printer.

**4** Wipe only the outside of the printer, making sure to remove any ink residue that has accumulated on the paper exit tray.

**Warning—Potential Damage:** Using a damp cloth to clean the interior may cause damage to your printer.

**5** Make sure the printer is dry before beginning a new print job.

## Cleaning the scanner glass

**1** Dampen a clean, lint-free cloth with water.

**2** Gently wipe the scanner glass clean.

**Note:** Make sure all ink or corrective fluid on a document is dry before placing the document on the scanner glass.

# Troubleshooting

## Before you troubleshoot

Use this checklist to solve most printer problems:

- Make sure the power cord is plugged into the printer and into a properly grounded electrical outlet.
- Make sure the printer is not plugged into any surge protectors, uninterrupted power supplies, or extension cords.
- Make sure the printer is turned on.
- Make sure the printer is securely connected to the host computer, print server, or other network access point.
- Check the printer for error messages, and resolve any errors.
- Check for paper jam messages, and clear any jams.
- Check the ink cartridges, and install new cartridges if necessary.
- Use the Service Center to locate and solve the problem (Windows only).
- Turn the printer off, wait about 10 seconds, and then turn the printer back on.

## Using the Service Center to solve printer problems

The Service Center provides step-by-step troubleshooting help and contains links to printer maintenance tasks and customer support.

To open the Service Center, use one of these methods:

Method 1	Method 2
If it appears on an error message dialog, click the <b>For additional assistance, use the Service Center</b> link.	<ol style="list-style-type: none"><li>1 Click  or <b>Start</b>.</li><li>2 Click <b>All Programs</b> or <b>Programs</b>, and then select the printer program folder from the list.</li><li>3 Select <b>Printer Home</b>.</li><li>4 From the Support tab, select <b>Service Center</b>.</li></ol>

## If Troubleshooting does not solve your problem

Visit our Web site at <http://support.lexmark.com> to find the following:

- Knowledgebase articles with the latest information and troubleshooting for your printer
- Live online technical support
- Contact numbers for telephone technical support

## Setup troubleshooting





- “Incorrect language appears on the display” on page 117
- “Printhead errors” on page 117
- “Software did not install” on page 119

- “Print job does not print or is missing pages” on page 120
- “Printer is printing blank pages” on page 121
- “Printer is busy or does not respond” on page 121
- “Cannot delete documents from the print queue” on page 122
- “Cannot print through USB” on page 122

## Incorrect language appears on the display

If the "Before you troubleshoot" checklist does not solve the problem, then try one or more of the following:



### CHANGE THE LANGUAGE USING THE PRINTER MENUS



- 1 From the printer control panel, press .
- 2 Press the arrow buttons to scroll to **Defaults**, and then press .
- 3 Press the arrow buttons to scroll to **Set Defaults**, and then press .
- 4 Press the arrow buttons to scroll to **Use Factory**, and then press .
- 5 Complete the initial printer setup.

### CHANGE THE LANGUAGE USING A BUTTON COMBINATION (IF YOU CANNOT READ THE CURRENT LANGUAGE)

- 1 Turn the printer off.

**Note:** If you have set the Power Saver timeout in the Setup menu, then press and hold  for three seconds to turn off the printer.

- 2 Press and hold down  and , and then press and release  to turn the printer on.

**Note:** Do not release  and  until **Language Selection** appears on the display, indicating that the printer has been reset.

- 3 Complete the initial printer setup.

## Printhead errors

If the "Before you troubleshoot" checklist does not solve the problem, then try the following:

## REMOVE AND REINSERT THE PRINTHEAD

- 1 Open the printer and lift the latch.

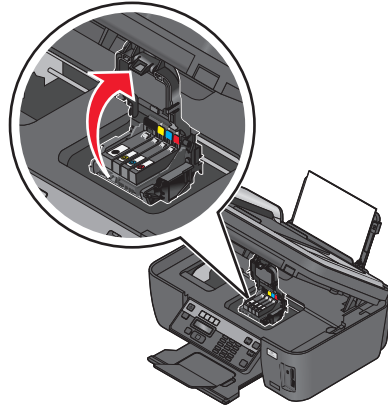

- 2 Remove the printhead.

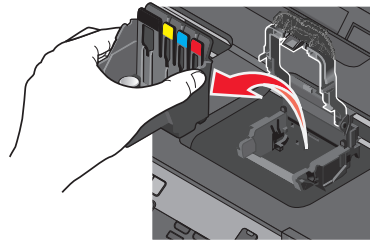

**Warning—Potential Damage:** Do not touch the printhead nozzles.

- 3 Wipe the printhead contacts using a clean, lint-free cloth.

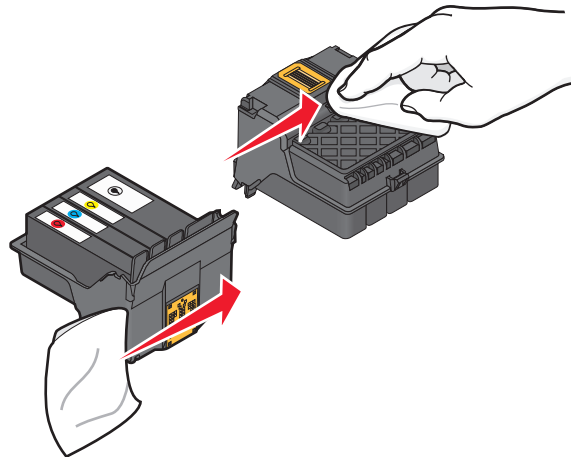

4 Reinsert the printhead, and then close the latch until it clicks.

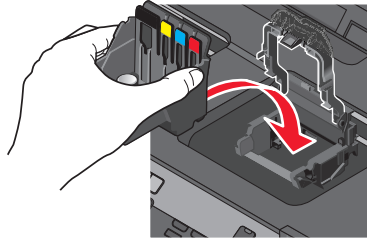

5 Close the printer.

**Note:** If removing and reinserting the printhead does not resolve the error, then contact technical support.

## Software did not install

If you encountered problems while installing, or if your printer does not appear in the list in the Printers folder or as a printer option when sending a print job, then try removing and reinstalling the software.

Before you reinstall the software, do the following:

**MAKE SURE THAT YOUR COMPUTER MEETS THE MINIMUM SYSTEM REQUIREMENTS LISTED ON THE PRINTER BOX**

**TEMPORARILY DISABLE SECURITY PROGRAMS IN WINDOWS BEFORE INSTALLING THE SOFTWARE**

### CHECK THE USB CONNECTION

- 1 Check the USB cable for any obvious damage. If the cable is damaged, then use a new one.
- 2 Firmly plug the square end of the USB cable into the back of the printer.
- 3 Firmly plug the rectangular end of the USB cable into the USB port of the computer.

The USB port is marked with a  USB symbol.

**Note:** If you continue to have problems, then try another USB port on the computer. You may have connected to a defective port.

### RECONNECT THE PRINTER POWER SUPPLY

- 1 Turn off the printer, and then unplug the power cord from the wall outlet.
- 2 Gently remove the power supply from the printer, and then reinsert it.
- 3 Plug the power cord into the wall outlet, and then turn on the printer.

## Print job does not print or is missing pages

If the "Before you troubleshoot" checklist does not solve the problem, then try one or more of the following:

### MAKE SURE THE INK CARTRIDGES ARE INSERTED CORRECTLY

- 1 Turn the printer on, and then open the printer.
- 2 Make sure the cartridges are inserted correctly.  
The cartridges should *click* firmly into the matching color slot of the printhead.
- 3 Close the printer.

### SELECT YOUR PRINTER FROM THE PRINT DIALOG BEFORE SENDING THE PRINT JOB

**Note:** This solution applies to Macintosh users only.

- 1 With a document open, choose **File > Print**.
- 2 From the printer pop-up menu, choose your printer, and then click **Print**.  
If your printer does not appear on the Printer list, then choose **Add Printer**. From the list of printers in the Default tab, select your printer, and then click **Add**.  
If your printer does not appear on the list, then try either of the following:
  - For a USB-connected printer, remove and then reconnect the USB cable.
  - For a printer that is wirelessly connected, see the Wireless troubleshooting section.

### MAKE SURE THE PRINT JOB IS NOT PAUSED

### MAKE SURE YOUR PRINTER IS SET AS THE DEFAULT PRINTER

### RECONNECT THE PRINTER POWER SUPPLY

- 1 Turn off the printer.  
**Note:** Make sure the printer is not in Power Saver mode. Press and hold  for three seconds to turn off the printer.
- 2 Unplug the power cord from the wall outlet, and then pull out the power cord from the power supply.
- 3 After one minute, reconnect the power cord into the power supply, and then plug the power cord into the wall outlet.
- 4 Turn on the printer.

### REMOVE AND RECONNECT THE USB CABLE CONNECTED TO YOUR PRINTER

### CHECK THE USB CONNECTION

- 1 Check the USB cable for any obvious damage. If the cable is damaged, then use a new one.
- 2 Firmly plug the square end of the USB cable into the back of the printer.



- 3 Firmly plug the rectangular end of the USB cable into the USB port of the computer.

The USB port is marked with a  USB symbol.

**Note:** If you continue to have problems, then try another USB port on the computer. You may have connected to a defective port.

## REMOVE AND REINSTALL THE PRINTER SOFTWARE

### Printer is printing blank pages

Blank pages may be caused by improperly installed ink cartridges.

## REINSTALL THE INK CARTRIDGES AND DEEP CLEAN AND ALIGN THE PRINTHEAD

- 1 Reinstall the ink cartridges, see “Replacing ink cartridges” on page 13 for more information.  
If the cartridges do not seem to fit, make sure the printhead is properly seated, and then try installing the cartridges again.
- 2 Load plain paper.
- 3 From the printer control panel, press .
- 4 Press the arrow buttons to scroll to **Maintenance**, and then press **OK**.
- 5 Press the arrow buttons to scroll to **Deep Clean Printhead**, and then press **OK**.  
A cleaning page prints.
- 6 Press the arrow buttons to scroll to **Align Printer**, and then press **OK**.  
An alignment page prints.

**Note:** Do not remove the alignment page until printing is finished.

### Printer is busy or does not respond

If the "Before you troubleshoot" checklist does not solve the problem, then try one or more of the following:

## MAKE SURE THE PRINTER IS NOT IN POWER SAVER MODE

If the power light is blinking on and off slowly, then the printer is in Power Saver mode. Press  to wake up the printer.

If the printer will not come out of Power Saver mode, then reset the power:

- 1 Unplug the power cord from the wall outlet, and then wait 10 seconds.
- 2 Insert the power cord into the wall outlet, and then turn on the printer.

If this problem persists, then check our Web site for updates for your printer software or firmware.

## RECONNECT THE PRINTER POWER SUPPLY

- 1 Turn off the printer, and then unplug the power cord from the wall outlet.
- 2 Gently remove the power supply from the printer, and then reinsert it.
- 3 Plug the power cord into the wall outlet, and then turn on the printer.

## Cannot delete documents from the print queue

If you have jobs stuck in the print queue and cannot delete them to get other jobs to print, then the computer and printer may not be communicating.

## RESTART THE COMPUTER AND TRY AGAIN

## Cannot print through USB

If the "Before you troubleshoot" checklist does not solve the problem, then try one or more of the following:

### CHECK THE USB CONNECTION

- 1 Check the USB cable for any obvious damage. If the cable is damaged, then use a new one.
- 2 Firmly plug the square end of the USB cable into the back of the printer.
- 3 Firmly plug the rectangular end of the USB cable into the USB port of the computer.

The USB port is marked with a  USB symbol.

**Note:** If you continue to have problems, then try another USB port on the computer. You may have connected to a defective port.

### MAKE SURE THE USB PORT IS ENABLED IN WINDOWS

- 1 Click , or click **Start** and then click **Run**.
- 2 In the Start Search or Run box, type `devmgmt.msc`.
- 3 Press **Enter**, or click **OK**.

The Device Manager opens.

- 4 Click the plus sign (+) beside Universal Serial Bus controllers.

If USB Host Controller and USB Root Hub are listed, then the USB port is enabled.

For more information, see the computer documentation.

## REMOVE AND REINSTALL THE PRINTER SOFTWARE

## Jams and misfeeds troubleshooting

- "Paper jam in the printer" on page 123
- "Paper jam in the paper support" on page 123

- “Paper jam in the duplex unit” on page 123
- “Paper jam in the ADF (selected models only)” on page 124
- “Paper or specialty media misfeeds” on page 125

## Paper jam in the printer

**Note:** The parts inside the printer are sensitive. Avoid unnecessarily touching these parts while clearing jams.

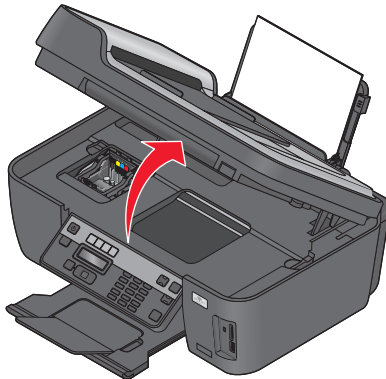

- 1 Press  to turn off the printer.
- 2 Check the paper tray or lift the scanner unit to check for jammed paper.



- 3 Firmly grasp the paper, and then gently pull it out.  
**Note:** Be careful not to tear the paper while removing it.
- 4 Press  to turn the printer back on.

## Paper jam in the paper support

**Note:** The parts inside the printer are sensitive. Avoid unnecessarily touching these parts while clearing jams.

- 1 Press  to turn off the printer.
- 2 Firmly grasp the paper, and then gently pull it out.  
**Note:** Be careful not to tear the paper while removing it.
- 3 Press  to turn the printer back on.

## Paper jam in the duplex unit

**Note:** The parts inside the printer are sensitive. Avoid unnecessarily touching these parts while clearing jams.

- 1 Push down the duplex latches and pull out the duplex unit.

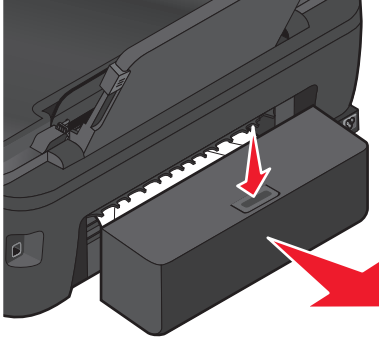

**⚠ CAUTION—POTENTIAL INJURY:** The area behind the duplex cover has protruding ribs as part of the paper path. To avoid injury, use caution when accessing this area for clearing a paper jam.

- 2 Firmly grasp the paper, and then gently pull it out.

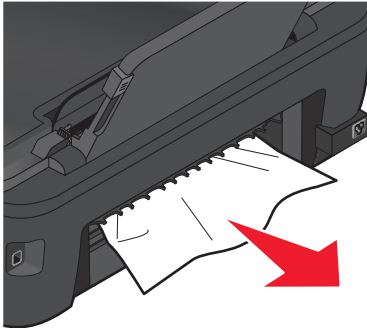

**Note:** Be careful not to tear the paper while removing it.

- 3 Reinsert the duplex unit.

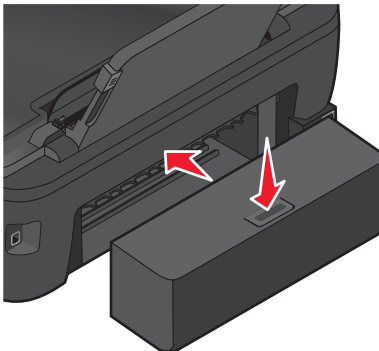

- 4 Touch **DONE** or press **OK**, depending on your printer model.
- 5 From your computer, resume the print job.

## Paper jam in the ADF (selected models only)

**Note:** The parts inside the printer are sensitive. Avoid unnecessarily touching these parts while clearing jams.

- 1 Open the ADF door, and then gently pull out the jammed paper.

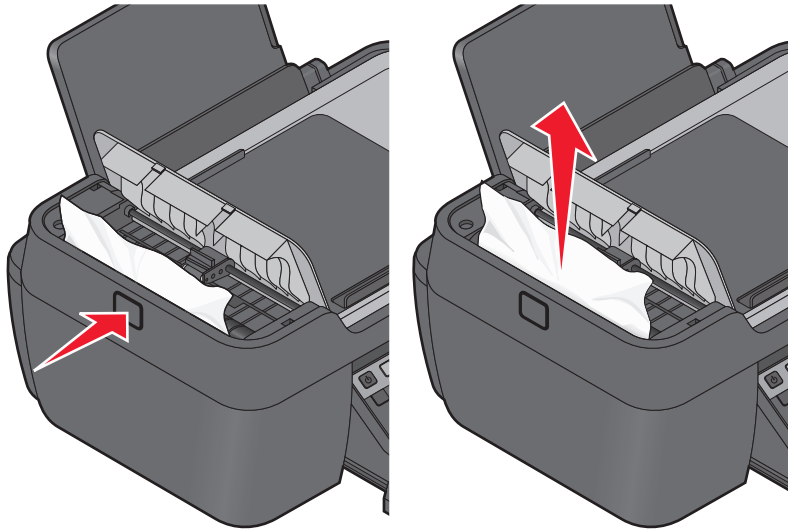

**Note:** Be careful not to tear the paper while removing it.

- 2 Close the ADF door.
- 3 Touch **DONE** or press **OK**, depending on your printer model.
- 4 From your computer, resume the print job.

## Paper or specialty media misfeeds

These are possible solutions if paper or specialty media misfeeds or skews, or if multiple sheets feed or stick together. Try one or more of the following:

### CHECK PAPER CONDITION

Use only new, unwrinkled paper.

### CHECK PAPER LOADING

- Load a smaller amount of paper into the printer.
- Load paper with the print side faceup. (If you are not sure which side is the printable side, see the instructions that came with the paper.)
- Check the loading instructions for your paper or specialty media.

### REMOVE EACH PAGE AS IT IS PRINTED

### ADJUST THE PAPER GUIDES TO FIT THE LOADED PAPER

# Print troubleshooting

- “Poor quality at the edges of the page” on page 126
- “Streaks or lines on printed image” on page 127
- “Print speed is slow” on page 127
- “Computer slows down when printing” on page 128

## Poor quality at the edges of the page

If the "Before you troubleshoot" checklist does not solve the problem, then try one or more of the following:

### CHECK MINIMUM PRINT SETTINGS

Unless you are using the borderless feature, use these minimum print margin settings:

- Left and right margins:
  - 6.35 mm (0.25 in.) for letter-size paper
  - 3.37 mm (0.133 in.) for all paper sizes except letter
- Top margin: 1.7 mm (0.067 in.)
- Bottom margin: 12.7 mm (0.5 in.)

### SELECT THE BORDERLESS PRINT FEATURE

#### For Windows users

- 1 With a document or photo open, click **File > Print**.
- 2 Click **Properties, Preferences, Options, or Setup**.
- 3 From the Paper Options area of the Print Setup tab, select **Borderless**.

#### For Macintosh users

- 1 With a photo open, choose **File > Page Setup**.

If there is no Page Setup item on the File menu, then go to step 2. Otherwise, specify your print settings:

- a From the Settings pop-up menu, choose **Page Attributes**.
  - b From the “Format for” pop-up menu, choose your printer.
  - c From the Paper Size pop-up menu, choose a paper size that has “(Borderless)” in its name.  
For example, if you loaded a 4 x 6 photo card, then choose **US 4 x 6 in (Borderless)**.
  - d Select an orientation, and then click **OK**.
- 2 From the menu bar, choose **File > Print**.  
If you have already specified the printer, paper size, and orientation in step 1, then you may have to choose your printer again from the Printer pop-up menu before going to step 3. Otherwise, set them:
    - a From the Printer pop-up menu, choose your printer.
    - b From the Paper Size pop-up menu, choose a paper size that has “(Borderless)” in its name.  
For example, if you loaded a 4 x 6 photo card, then choose **US 4 x 6 in (Borderless)**.
    - c Select an orientation.

- 3 If necessary, click **Advanced**.
- 4 From the print options pop-up menu, choose **Print Settings** or **Quality & Media**.
  - From the Paper Type pop-up menu, choose a paper type.
  - From the Print Quality pop-up menu, choose **Photo** or **Best**.
- 5 Click **Print**.

## Streaks or lines on printed image

If the "Before you troubleshoot" checklist does not solve the problem, then try one or more of the following:

### CHECK THE INK LEVELS

Replace low or empty ink cartridges.

### SELECT A HIGHER PRINT QUALITY FROM THE PRINTER SOFTWARE

### MAKE SURE THE INK CARTRIDGES ARE PROPERLY INSTALLED

### ALIGN THE PRINTHEAD

### CLEAN OR DEEP CLEAN THE PRINTHEAD NOZZLES

**Note:** If these solutions do not remove the streaks or lines on the printed image, then contact technical support.

## Print speed is slow

If the "Before you troubleshoot" checklist does not solve the problem, then try one or more of the following:

### MAXIMIZE COMPUTER PROCESSING SPEED

- Close all applications not in use.
- Minimize the number and size of graphics and images in the document.
- Remove as many unused fonts as possible from your system.

### ADD MEMORY

Consider purchasing more RAM.

### SELECT A LOWER PRINT QUALITY FROM THE PRINTER SOFTWARE

### MANUALLY SELECT A PAPER TYPE THAT MATCHES THE TYPE OF PAPER YOU ARE USING

### REMOVE AND REINSTALL THE PRINTER SOFTWARE

## Computer slows down when printing

These are possible solutions. Try one of the following:

**IF YOU ARE USING A USB CONNECTION, THEN TRY A DIFFERENT USB CABLE**

**IF YOU ARE ON A NETWORK, THEN RESET THE POWER OF THE ACCESS POINT (ROUTER)**

- 1 Unplug the power cord from the access point.
- 2 Wait ten seconds, and then insert the power cord.

## Copy and scan troubleshooting

- “Copier or scanner does not respond” on page 128
- “Scanner unit does not close” on page 128
- “Poor copy or scanned image quality” on page 128
- “Partial copies or scans of documents or photos” on page 129
- “Scan was not successful” on page 129
- “Scanning takes too long or freezes the computer” on page 130
- “Cannot scan to a computer over a network” on page 130

## Copier or scanner does not respond

If the "Before you troubleshoot" checklist does not solve the problem, then try one or more of the following:

**SET YOUR PRINTER AS THE DEFAULT PRINTER**

**REMOVE AND REINSTALL THE PRINTER SOFTWARE**

## Scanner unit does not close

- 1 Lift the scanner unit.
- 2 Remove any obstruction keeping the scanner unit open.
- 3 Lower the scanner unit.

## Poor copy or scanned image quality

If the "Before you troubleshoot" checklist does not solve the problem, then try one or more of the following:

**CLEAN THE SCANNER GLASS**

**ADJUST THE SCAN QUALITY FROM THE PRINTER SOFTWARE**



## REVIEW THE TIPS FOR COPYING, SCANNING, AND IMPROVING PRINT QUALITY

### USE A CLEARER VERSION OF THE ORIGINAL DOCUMENT OR IMAGE

**MAKE SURE THE DOCUMENT OR PHOTO IS LOADED FACEDOWN ON THE SCANNER GLASS AND IN THE CORRECT CORNER**

### Partial copies or scans of documents or photos

If the "Before you troubleshoot" checklist does not solve the problem, then try one or more of the following:

**MAKE SURE THE DOCUMENT OR PHOTO IS LOADED FACEDOWN ON THE SCANNER GLASS AND IN THE CORRECT CORNER**

**SELECT A PAPER SIZE FROM THE PRINTER SOFTWARE THAT MATCHES THE LOADED PAPER**

**MAKE SURE THE ORIGINAL SIZE SETTING MATCHES THE SIZE OF THE DOCUMENT YOU ARE SCANNING**

### Scan was not successful

If the "Before you troubleshoot" checklist does not solve the problem, then try one or more of the following:

#### CHECK THE USB CONNECTION

- 1 Check the USB cable for any obvious damage. If the cable is damaged, then use a new one.
- 2 Firmly plug the square end of the USB cable into the back of the printer.
- 3 Firmly plug the rectangular end of the USB cable into the USB port of the computer.

The USB port is marked with .

**Note:** If you continue to have problems, then try another USB port on the computer. You may have connected to a defective port.

#### RESTART THE COMPUTER

#### ADD NETWORK PRINTERS THROUGH THE EDIT DEVICE LIST DIALOG

If you are scanning from a network printer, then add that printer using the Edit Device List dialog. For more information, see the Edit Device List Help:

- 1 With the Scan Center application open, choose **Browse Devices** from the Device pop-up menu.
- 2 Click  from the Edit Device List dialog that appears.

## **MAKE SURE “ENABLE NETWORK SCAN TO COMPUTER” IS SELECTED IN THE GENERAL TAB OF THE SCAN CENTER (MACINTOSH ONLY)**

### **Notes:**

- This is available only in Mac OS X version 10.6.
- If you have several applications open, then make sure that the Scan Center is the active application. Otherwise, the correct menu bar does not appear.

From the menu bar, navigate to:

**Scan Center > Preferences > General tab**

## **Scanning takes too long or freezes the computer**

If the "Before you troubleshoot" checklist does not solve the problem, then try one or more of the following:

**CLOSE OTHER SOFTWARE PROGRAMS THAT ARE NOT BEING USED**

**USE A LOWER SCANNING RESOLUTION**

## **Cannot scan to a computer over a network**

If the "Before you troubleshoot" checklist does not solve the problem, then try one or more of the following:

**MAKE SURE THE PRINTER AND THE DESTINATION COMPUTER ARE CONNECTED TO THE SAME NETWORK**

**MAKE SURE THE PRINTER SOFTWARE IS INSTALLED ON THE DESTINATION COMPUTER**

## **MAKE SURE “ENABLE NETWORK SCAN TO COMPUTER” IS SELECTED IN THE GENERAL TAB OF THE SCAN CENTER (MACINTOSH ONLY)**

### **Notes:**

- This is available only in Mac OS X version 10.6.
- If you have several applications open, then make sure that the Scan Center is the active application. Otherwise, the correct menu bar does not appear.

From the menu bar, navigate to:

**Scan Center > Preferences > General tab**

## **Fax troubleshooting**

- “Fax troubleshooting checklist” on page 131
- “Cannot send faxes” on page 132
- “Cannot receive faxes” on page 134

- “Cannot run the fax software” on page 135
- “Fax error messages on the printer control panel” on page 135

For detailed descriptions of common terms and tasks, see the following:

- “Setting up the printer to fax” on page 65
- “Faxing FAQ” on page 82

## Fax troubleshooting checklist

Before you troubleshoot, use the following checklist to solve most fax problems:

- Check the dial tone to make sure that the cable connections are correct and that the telephone line is working.

To check the dial tone:

- 1 Plug an analog telephone into the wall jack.
- 2 Listen for a dial tone through the telephone handset.

If you hear a dial tone, then the connections are correct and the line is working.

If you do not hear a dial tone, then check the other items on the checklist, and then listen for a dial tone after checking each item.

- Make sure that the devices are set up correctly according to your setup scenario in the “Setting up the printer to fax” section.
- Make sure that the cables are connected to the correct ports.
- Make sure that the cables are securely plugged in.

Check the cable connections for the following hardware, if applicable:

- Power supply
- Telephone
- Answering machine
- VoIP adapter
- DSL filter
- Splitter
- Cable modem

- If the printer is connected to a Digital Subscriber Line, install a DSL filter for the printer. A DSL filter minimizes interference between the fax signals and Internet signals on the line. Connect the printer to the phone port on the DSL filter, and connect the computer to the DSL/HPN port on the filter.

To make sure that you connected the printer to the filter correctly, plug an analog phone into the  port on the back of the printer, and then listen for a dial tone.

- If the printer is connected to a VoIP line, then make sure that the printer is plugged into an active phone port. Plug the printer into the first port on the VoIP adapter, most often labeled as Phone Port or Phone Line 1.

To make sure that the phone port is active, plug an analog phone into the port, and then listen for a dial tone.

- If you are using a splitter, then make sure that you are using a phone splitter. Do *not* use a line splitter. To make sure that you are using the correct splitter, plug an analog phone into the splitter, and then listen for a dial tone.
- If you have checked the items on this list but still do not hear a dial tone, then contact your line provider.

## Cannot send faxes

If the “Fax troubleshooting checklist” does not solve the problem, then try one or more of the following:

### MAKE SURE THAT YOU HAVE REGISTERED YOUR USER INFORMATION IN THE PRINTER

If you did not enter your user information during initial setup, then enter your fax name and fax number. In some countries, you cannot send a fax without entering your fax name or company name. Some fax machines also block unknown faxes or faxes without sender information.

### DECREASE THE TRANSMISSION SPEED OF THE FAX MODEM

The modem of the printer can transmit data at 33,600 bps. This is the maximum speed at which the printer can send and receive faxes. It is not necessary, however, to set the modem to its fastest transmission capability. The speed of the modem of the receiving fax machine must match or be greater than the speed at which you are sending your fax. Otherwise, your fax will not be received.

To decrease the transmission speed of the modem:

- 1 From the printer control panel, press .
- 2 Press the arrow buttons to scroll to **Fax Setup**, and then press **OK**.
- 3 Press the arrow buttons to scroll to **Dialing and Sending**, and then press **OK**.
- 4 Press the arrow buttons to scroll to **Max Send Speed**, and then press **OK**.
- 5 Select a sending speed, and then press **OK**.

### SET THE PRINTER TO SCAN THE ORIGINAL DOCUMENT BEFORE DIALING THE NUMBER

The printer does not automatically redial if you set it to scan the original document after dialing the number.

Set the printer to scan before dialing so that you do not have to scan the document again if the fax fails. The scanned document is saved in the printer memory. The printer can then retrieve it and automatically redial the number.

To set the printer to scan before dialing:

- 1 From the printer control panel, press .
- 2 Press the arrow buttons to scroll to **Fax Setup**, and then press **OK**.
- 3 Press the arrow buttons to scroll to **Dialing and Sending**, and then press **OK**.
- 4 Press the arrow buttons to scroll to **Scan**, and then press **OK**.
- 5 Press the arrow buttons to scroll to **Before Dial**, and then press **OK**.

### ENABLE ERROR CORRECTION

Errors and blurs may appear in the faxed document if there is too much noise on the line. This option enables the printer to transmit the bad blocks of data again and correct the errors. When a fax has too many errors, the fax may be rejected by the receiving fax machine.

To make sure that error correction is enabled:

- 1 From the printer control panel, press .
- 2 Press the arrow buttons to scroll to **Fax Setup**, and then press **OK**.
- 3 Press the arrow buttons to scroll to **Dialing and Sending**, and then press **OK**.
- 4 Press the arrow buttons to scroll to **Error Correction**, and then press **OK**.
- 5 Check to see if error correction is set to On.  
If it is not set to On, press the arrow buttons to select **On**, and then press **OK**.

## ENABLE AUTOMATIC FAX CONVERSION

If the receiving fax machine does not support color fax, then this option automatically converts the outgoing color fax to black and white. It also automatically reduces the resolution of the fax to a resolution that the receiving machine can support.

To make sure that automatic fax conversion is enabled:

- 1 From the printer control panel, press .
- 2 Press the arrow buttons to scroll to **Fax Setup**, and then press **OK**.
- 3 Press the arrow buttons to scroll to **Dialing and Sending**, and then press **OK**.
- 4 Press the arrow buttons to scroll to **Auto Fax Convert**, and then press **OK**.
- 5 Check to see if automatic fax conversion is set to On.  
If it is not set to On, press the arrow buttons to select **On**, and then press **OK**.

## MAKE SURE THAT THE DIAL PREFIX SETTING IS CORRECT

The dialing prefix is the number or series of numbers that you press before you can dial the actual fax number or telephone number. If the printer is in an office setting or in a private branch exchange, this can be a specific number that you need to press so you can make a call outside the office.

Make sure that the dial prefix entered in the printer is correct for your network.

To check the dial prefix setting:

- 1 From the printer control panel, press .
- 2 Press the arrow buttons to scroll to **Fax Setup**, and then press **OK**.
- 3 Press the arrow buttons to scroll to **Dialing and Sending**, and then press **OK**.
- 4 Press the arrow buttons to scroll to **Dial Prefix**, and then press **OK**.
- 5 Press the arrow buttons to create or modify the prefix.
- 6 If the prefix is not correct, enter the correct prefix, and then press **OK**.

## Cannot receive faxes

If the “Fax troubleshooting checklist” does not solve the problem, then try one or more of the following:

### MAKE SURE THAT YOU HAVE CONFIGURED THE CORRECT SETTINGS FOR YOUR SETUP

The fax settings depend on whether the printer is connected to its own fax line or shares the line with other devices.

If the printer is sharing the telephone line with an answering machine, then make sure that the following are set:

- Auto Answer is On.
- The printer picks up on a greater number of rings than the answering machine.
- The printer picks up on the correct distinctive ring (if you subscribe to a distinctive ring service).

If the printer is sharing the telephone line with a telephone subscribed to voice mail, then make sure that the following are set:

- Auto Answer is Off (if you have only one number on the telephone line).
- The printer picks up on the correct distinctive ring (if you subscribe to a distinctive ring service).

### MAKE SURE THAT THE PRINTER IS CONNECTED TO AN ANALOG PORT

The printer is an analog device. If you are using a PBX system, then make sure that the printer is connected to an analog port on the PBX. You may need a digital line converter that converts digital signals into analog signals.

### MAKE SURE THAT THE PRINTER MEMORY IS NOT FULL

The printer saves an incoming fax to the printer memory before it prints the fax. If the printer runs out of ink or runs out of paper while receiving the fax, then the printer saves the fax so you can print it later. However, if the printer memory is full, then the printer may not be able to receive more incoming faxes. An error message appears on the display when the printer memory is full. Resolve the error to free up space in the printer memory.

### MAKE SURE THAT FAX FORWARDING IS DISABLED

You may have turned on Fax Forwarding. Disable this option so that the printer can receive the fax.

- 1 From the printer control panel, press .
- 2 Press the arrow buttons to scroll to **Fax Setup**, and then press **OK**.
- 3 Press the arrow buttons to scroll to **Ringing and Answering**, and then press **OK**.
- 4 Press the arrow buttons to scroll to **Fax Forward**, and then press **OK**.
- 5 Press the arrow buttons to scroll to **Off**, and then press **OK**.

### INCREASE THE RINGER VOLUME

If you set the printer to receive faxes manually (Auto Answer Off), then increase the ringer volume.

### MAKE SURE THAT YOU HAVE THE CORRECT MANUAL ANSWER CODE

If you set the printer to receive faxes manually (Auto Answer Off), then you need to press the correct code when a fax comes in so that the printer can receive it.

To retrieve the correct code:

- 1 From the printer control panel, press .
- 2 Press the arrow buttons to scroll to **Fax Setup**, and then press **OK**.
- 3 Press the arrow buttons to scroll to **Ringling and Answering**, and then press **OK**.
- 4 Press the arrow buttons to scroll to **Manual Pickup Code**, and then press **OK**.
- 5 Copy the manual answer code that appears on the display.

## Cannot run the fax software

The printer must be connected to a telephone, DSL, or VoIP line before you can configure the fax settings in the fax software.

### MAKE SURE THE FAX SOFTWARE IS INSTALLED

The Fax Solutions Software is optional for Windows users and is installed with the printer software only if you select it on the “Install Additional Software” screen during installation. If you did not install the fax software, then the fax tab on the Printer Home takes you to our Web site where you can download the software.

### MAKE SURE THE PRINTER IS CONNECTED TO A TELEPHONE LINE

You need to connect the printer to your telephone line (through a standard wall jack, a DSL filter, or a VoIP adapter) before you can open the fax software and configure the fax settings.

### MAKE SURE THAT THE PRINTER IS CONNECTED TO THE COMPUTER

### MAKE SURE THAT THE PRINTER IS NOT IN POWER SAVER MODE

## Fax error messages on the printer control panel

Error Message:	What it indicates:	Possible solutions:
<b>Remote Fax Error</b>	The receiving fax machine cannot receive the fax. The error on the receiving end could be due to several factors.	<ul style="list-style-type: none"><li>• Resend the fax. There may have been a problem with the quality of the connection.</li><li>• Decrease the transmission speed of your fax modem.</li><li>• Register your user information. In some countries, you cannot send a fax without registering your fax name and fax number. Some fax machines also block faxes without sender information.</li></ul>

Error Message:	What it indicates:	Possible solutions:
<b>Fax Mode Unsupported</b>	The receiving fax machine does not support color fax or the scan resolution of the document that you are sending.	<ul style="list-style-type: none"> <li>• Enable Auto Fax Conversion. The printer automatically converts color faxes to black and lowers the scan resolution of the document.</li> <li>• Lower the fax quality.</li> <li>• Reformat the document on Letter-size paper.</li> </ul>
<b>Unsupported Compression</b>	The fax modem of the receiving fax machine does not support data compression. Fax modems compress data to speed up transmission, but the receiving fax modem needs to have the same compression code.	<ul style="list-style-type: none"> <li>• Lower the transmission speed of the fax modem, and then resend the fax.</li> <li>• Enable Auto Fax Conversion.</li> </ul>
<b>Unsupported Resolution</b>	The receiving fax machine does not support the scan resolution of the document that you are sending.	<ul style="list-style-type: none"> <li>• Lower the fax quality.</li> <li>• Enable Auto Fax Conversion.</li> </ul>
<b>Unrecoverable Fax Error</b>	The fax modem encountered critical errors.	Turn off the printer, turn it back on, and then resend the fax.
<b>Fax Modem Error</b>	The fax modem of the printer may be busy, or the fax modem may have encountered problems during transmission.	Turn off the printer, turn it back on, and then resend the fax.
<b>Phone Line is connected to the incorrect jack on the back of the machine.</b>	The telephone cable is connected to the wrong port on the back of the printer.	Connect the phone cable to the  port on the back of the printer.
<b>Digital line detected</b>	The printer is connected to a digital line.	<p>The printer is an analog device and must be connected to an analog line. To connect the printer to a digital line, you must use a digital line converter or a filter.</p> <p>For more information, see the "Setting up the printer to fax" section.</p>
<b>Failed to Connect Phone Line Error Phone Line Not Connected</b>	The printer cannot detect a dial tone.	See the "Fax troubleshooting checklist."



Error Message:	What it indicates:	Possible solutions:
<b>Phone Line Busy</b>	Your telephone line or the telephone line of the receiving fax machine is busy. This happens especially if the printer is sharing the line with other devices (telephone, answering machine).	<ul style="list-style-type: none"> <li>• Set the printer to redial.</li> <li>• Increase the time between the redial attempts.</li> <li>• Place a test call to the number to which you want to send a fax to make sure that it is working correctly.</li> <li>• If the telephone line is being used by another device, then wait until the other device is finished before sending the fax.</li> <li>• Schedule to resend the fax at a later time.</li> <li>• Set the printer to scan before dialing. The scanned document is saved in the printer memory. The printer can then retrieve it and automatically redial the number.</li> </ul>
<b>No Answer</b>	Auto Answer may have been turned off on the receiving fax machine.	<ul style="list-style-type: none"> <li>• Verify the number, and then resend the fax.</li> <li>• Set the printer to redial. <b>Note:</b> Depending on your country or region, there may be a limit on the number of redial attempts, regardless of the redial settings that you set in your printer.</li> <li>• Schedule to resend the fax at a later time.</li> </ul>
<b>No Caller ID Call Stopped</b>	Your printer stopped the call because the incoming fax has no sender information. You may have chosen to block faxes with no Caller ID or faxes without Caller IDs are not allowed in your country or region.	Disable Block No-ID.

To troubleshoot error messages in the fax software, click **Help** to view the help information for the fax software.

## Memory card troubleshooting

- “Memory card troubleshooting checklist” on page 138
- “Nothing happens when a memory card is inserted” on page 138
- “Cannot print documents from a memory card or flash drive” on page 138
- “Photos do not transfer from a memory card across a wireless network” on page 139

## Memory card troubleshooting checklist

Before you troubleshoot, use the following checklist to solve most memory card problems:

- Make sure that the memory card you are using can be used in the printer.
- Make sure the memory card is not damaged.
- Make sure memory card contains supported file types.

## Nothing happens when a memory card is inserted

If the "Memory card troubleshooting checklist" does not solve the problem, then try one or more of the following:

### REINSERT THE MEMORY CARD

The memory card may have been inserted too slowly. Remove and then reinsert the memory card quickly.

### CHECK THE USB CONNECTION

- 1 Check the USB cable for any obvious damage. If the cable is damaged, then use a new one.
- 2 Firmly plug the square end of the USB cable into the back of the printer.
- 3 Firmly plug the rectangular end of the USB cable into the USB port of the computer.

The USB port is marked with a  USB symbol.

**Note:** If you continue to have problems, then try another USB port on the computer. You may have connected to a defective port.

### CHECK THE NETWORK CONNECTION

If the printer and computer are connected over a network, then make sure that the correct host and device are communicating. Select the printer from the computer or the computer from the printer.

## Cannot print documents from a memory card or flash drive

If the "Memory card troubleshooting checklist" does not solve the problem, then try the following:

### CHECK THE USB CONNECTION

- 1 Check the USB cable for any obvious damage. If the cable is damaged, then use a new one.
- 2 Firmly plug the square end of the USB cable into the back of the printer.
- 3 Firmly plug the rectangular end of the USB cable into the USB port of the computer.

The USB port is marked with a  USB symbol.

**Note:** If you continue to have problems, then try another USB port on the computer. You may have connected to a defective port.

## **CHECK THE NETWORK CONNECTION**

If the printer and computer are connected over a network, then make sure that the correct host and device are communicating. Select the printer from the computer or the computer from the printer.

## **Photos do not transfer from a memory card across a wireless network**

If the "Memory card troubleshooting checklist" does not solve the problem, then try one or more of the following:

### **MAKE SURE THAT BOTH THE PRINTER AND THE DESTINATION COMPUTER ARE TURNED ON AND READY**

### **MAKE SURE "ENABLE READING FROM A MEMORY DEVICE OVER THE NETWORK FROM YOUR PRINTER" IS SELECTED IN THE PREFERENCES DIALOG OF THE NETWORK CARD READER (MACINTOSH ONLY)**

#### **Notes:**

- This is available only in Mac OS X version 10.6.
- If you have several applications open, then make sure that the Network Card Reader is the active application. Otherwise, the correct menu bar does not appear.

From the menu bar, navigate to:

**Network Card Reader > Preferences**

### **SELECT THE CORRECT COMPUTER NAME FROM THE LIST ON THE PRINTER**

### **MAKE SURE YOUR WIRELESS NETWORK IS CONNECTED AND ACTIVE**

If your wireless connection is down, then use a USB cable to connect your printer to your computer.

## **Wireless troubleshooting**

- "Wireless troubleshooting checklist" on page 140
- "Resetting the wireless settings to factory defaults" on page 140
- "Cannot print over wireless network" on page 141
- "The Continue button is unavailable" on page 144
- "Cannot print and there is a firewall on the computer" on page 145
- "Wi-Fi indicator light is not lit" on page 145
- "Wi-Fi indicator light is green but the printer does not print (Windows only)" on page 146
- "Wi-Fi indicator light is still orange" on page 147
- "Wi-Fi indicator light is blinking orange during installation" on page 148
- "Wireless print server not installed" on page 152
- "'Communication not available' message displays when printing wirelessly" on page 152
- "Communication with printer lost when connected to Virtual Private Network (VPN)" on page 154
- "Resolving intermittent wireless communications issues" on page 154

## Wireless troubleshooting checklist

Before beginning to troubleshoot the wireless printer, verify the following:

- The printer, the computer, and the wireless access point are all plugged in and turned on.
- The wireless network is working properly.  
Try accessing other computers on your wireless network.  
If your network has Internet access, try connecting to the Internet over a wireless connection.
- Your SSID is correct.  
Print a network setup page to verify the SSID the printer is using.  
If you are not sure if your SSID is correct, then run the wireless setup again.
- Your WEP key or WPA passphrase is correct (if your network is secure).  
Log into the wireless access point (wireless router) and check the security settings.  
A security key is like a password. All devices on the same wireless network using WEP, WPA, or WPA2 share the same security key.  
If you are not sure if your security information is correct, run the wireless setup again.
- The printer and the computer are within the range of the wireless network.  
For most networks, the printer and the computer should be within 100 feet (30 meters) of the wireless access point (wireless router).
- The Wi-Fi indicator light is lit and is solid green.
- The printer driver is installed on the computer from which you are performing a task.
- The correct printer port is selected.
- The computer and printer are both connected to the same wireless network.
- The printer is located away from obstacles or electronic devices that could interfere with the wireless signal.  
Make sure the printer and wireless access point are not separated by poles, walls, or support columns containing metal or concrete.  
Many devices can interfere with the wireless signal, including baby monitors, motors, cordless phones, security system cameras, other wireless networks, and some Bluetooth devices.

## Resetting the wireless settings to factory defaults

- 1 From the printer control panel, press .
- 2 Press the arrow buttons to scroll to **Network Setup**, and then press **OK**.
- 3 Press the arrow buttons to scroll to **Reset Network Adapter Defaults**, and then press **OK**.
- 4 Press the arrow buttons to scroll to **Yes**, and then press **OK**.  
The printer wireless settings are reset to factory default settings. To verify, print a network setup page.

## Cannot print over wireless network

If you encountered problems while installing, or if your printer does not appear in the printers folder or as a printer option when sending a print job, then you can try uninstalling and reinstalling the software.

Before you reinstall the software, check the troubleshooting checklist, and then do the following:

### TURN THE ACCESS POINT (WIRELESS ROUTER) OFF AND THEN BACK ON

Wait one minute for the printer and computer to reestablish the connection. This can sometimes refresh network connections and resolve connectivity issues.

### DISCONNECT FROM VPN SESSION

When you are connected to another network through a VPN connection, you will not be able to access the printer over your wireless network. End your VPN session and try printing again.

### MAKE SURE DEMO MODE IS TURNED OFF

Select printer features are not available when Demo Mode is turned on.

From the home screen, navigate to:

 > **Demo Mode** > **Off** > save the setting

### CHECK YOUR WEP KEY OR WPA PASSPHRASE

If your access point is using WEP security, then the WEP key should be:

- Exactly 10 or 26 hexadecimal characters. Hexadecimal characters are A–F, a–f, and 0–9.

*or*

- Exactly 5 or 13 ASCII characters. ASCII characters are letters, numbers, and symbols found on a keyboard. ASCII characters in a WEP key are case-sensitive.

If your access point is using WPA or WPA2 security, then the WPA passphrase should be:

- Exactly 64 hexadecimal characters. Hexadecimal characters are A–F, a–f, and 0–9.

*or*

- From 8 to 63 ASCII characters. ASCII characters are letters, numbers, and symbols found on a keyboard. ASCII characters in a WPA passphrase are case-sensitive.

**Note:** If you do not know this information, then see the documentation that came with the wireless network, or contact the person who set up your wireless network.

### CHECK IF YOUR ACCESS POINT HAS AN ASSOCIATION/REGISTRATION BUTTON

Wireless broadband boxes in Europe, the Middle East, and Africa such as LiveBox, AliceBox, N9UF Box, FreeBox, or Club Internet may require you to press an association/registration button when adding the printer to your wireless network.

If you are using one of these boxes and need more information, then see the documentation that came with your box, or contact your *Internet Service Provider* (ISP).

## MOVE YOUR ACCESS POINT AWAY FROM OTHER ELECTRONIC DEVICES

There may be temporary interference from electronic devices such as microwave ovens or other appliances, cordless phones, baby monitors, and security system cameras. Make sure your access point is not positioned too closely to these devices.

## MOVE THE COMPUTER AND/OR PRINTER CLOSER TO THE ACCESS POINT

The range of your wireless network depends on many factors, including the abilities of your access point and network adapters. If you are having trouble printing, then try placing the computer and printer no more than 100 feet apart.

## CHECK THE WIRELESS SIGNAL QUALITY

Print a network setup page and check the signal quality. If the signal quality is listed as good or excellent, then another factor is causing the problem.

## CHECK YOUR ADVANCED SECURITY SETTINGS

- If you are using MAC (Media Access Control) address filtering to limit access to your wireless network, then you must add the printer MAC address to the list of addresses allowed to connect to the access point.
- If you set the access point to issue a limited number of IP addresses, then you must change this so that the printer can be added.

**Note:** If you do not know how to make these changes, then see the documentation that came with the access point, or contact the person who set up your wireless network.

## MAKE SURE YOUR COMPUTER IS CONNECTED TO YOUR ACCESS POINT

- See if you have access to the Internet by opening your Web browser and accessing any site.
- If there are other computers or resources on your wireless network, then check to see if you can access them from your computer.

## MAKE SURE THAT YOUR COMPUTER AND PRINTER ARE CONNECTED TO THE SAME WIRELESS NETWORK

If the printer is not on the same wireless network as the computer, then you will not be able to print wirelessly. The SSID of the printer must match the SSID of the computer, if the computer is already connected to the wireless network.

### For Windows users

- 1 Obtain the SSID of the network that the computer is connected to.
  - a Type the IP address of your access point into the address field of your Web browser.

If you do not know the IP address of the access point:

- 1 Click , or click **Start** and then click **Run**.
  - 2 In the Start Search or Run box, type **cmd**.
  - 3 Press **Enter** or click **OK**.
  - 4 Type **ipconfig**, and then press **Enter**. Check the Wireless Network Connection section:
    - The “Default Gateway” entry is typically the access point .
    - The IP address appears as four sets of numbers separated by periods, such as 192.168.2.134.
- b Type the user name and password of the access point when prompted.
  - c Click **OK**.

- d In the Wireless settings section, look for the SSID.
- e Write down the SSID.

**Note:** Make sure you copy it exactly, including any capital letters.

**2** Obtain the SSID of the network that the printer is connected to:

- a From the printer, print a network setup page.
- b In the Wireless section, look for **SSID**.

**3** Compare the SSID of the computer and SSID of the printer.

If the SSIDs are the same, then the computer and the printer are connected to the same wireless network.

If the SSIDs are not the same, then run the utility again to set up the printer on the wireless network used by the computer.

### **For Macintosh users with an AirPort base station**

#### **In Mac OS X version 10.5 or later**

**1** From the Apple menu, navigate to:

**System Preferences > Network > AirPort**

The SSID of the network that the computer is connected to is displayed in the Network Name menu.

**2** Write down the SSID.

#### **In Mac OS X version 10.4 or earlier**

**1** From the Finder, navigate to:

**Applications > Internet Connect > AirPort**

The SSID of the network that the computer is connected to is displayed in the Network menu.

**2** Write down the SSID.

### **For Macintosh users with an access point**

**1** Type the IP address of the access point in the address field of your Web browser, and then continue to step 2.

If you do not know the IP address of the access point, then do the following:

- a From the Apple menu, navigate to:  
**System Preferences > Network > AirPort**
- b Click **Advanced** or **Configure**.
- c Click **TCP/IP**.

The Router entry is typically the access point.

**2** Type your user name and password when prompted, and then click **OK**.

**3** In the Wireless settings section, look for the SSID.

**4** Write down the SSID, security type, and the WEP key/WPA passphrase (if shown).

#### **Notes:**

- Make sure you copy the network information down exactly, including any capital letters.
- Store the SSID and the WEP key or WPA passphrase in a safe place for future reference.

## **MAKE SURE YOUR OS IS COMPATIBLE WITH WIRELESS PRINTING THROUGH AIRPORT**

The printer supports wireless printing only through AirPort base stations for Mac OS X version 10.5 or later.

## **The Continue button is unavailable**

Try the following solutions in the order they appear until the Continue button becomes active and can be clicked:

### **CHECK IF THE USB CABLE IS SECURELY PLUGGED INTO THE USB PORTS ON BOTH THE COMPUTER AND THE PRINTER**

USB ports are marked with the  symbol.

### **MAKE SURE THAT THE PRINTER IS PLUGGED IN AND TURNED ON**

Check to see if the  button is lit. If you have just turned on the printer, then you might need to disconnect the USB cable and reconnect it.

### **MAKE SURE THAT THE USB PORT ON THE COMPUTER IS WORKING**

Test the USB port by connecting other devices to it. If you can successfully use other devices from the port, then the port is working.

If the USB port on the computer is not working, then try using the other USB ports on the computer.

### **MAKE SURE THAT THE USB CABLE IS WORKING**

Try using a different USB cable. If you are using a cable longer than 10 feet, then try using a shorter cable.

### **MAKE SURE THAT YOU ARE USING THE CORRECT CD FOR YOUR PRINTER MODEL**

Compare the printer model on the CD to the printer model on the printer. The numbers should either match exactly or be within the same series.

If you have any doubts, look for an updated version of the printer software on our Web site. For more information, see “Installing the printer software” in the *User's Guide*. You can access the *User's Guide* from the link at the bottom of the installation screen.

### **RECONNECT THE POWER SUPPLY**

- 1 Turn off the printer.
- 2 Unplug the power cord from the power outlet.
- 3 Remove the power supply from the back of the printer and then plug it back in.
- 4 Plug the power cord back into the power outlet.
- 5 Turn on the printer, and then resume the installation on your computer.



## TRY RUNNING THE INSTALLER AGAIN

- 1 Close the installer.
- 2 Remove the CD, and then restart the computer.
- 3 Insert the CD and then run the installer again.

### Notes:

- When you get to the **Software Already Installed** screen, make sure you select **Install a printer**.
- If you have already set up your printer, select **Additional Computer** when you get to the **Setting up a new printer?** screen to skip the hardware setup wizard.

## CHECK THAT YOUR COMPUTER IS ABLE TO ACKNOWLEDGE USB ACTIVITY ON THE USB PORT

Open the Device Manager to check if it has activity whenever a USB device is connected to a USB port:

- 1 Click , or click **Start** and then click **Run**.
- 2 In the Start Search or Run box, type `devmgmt.msc`.
- 3 Press **Enter**, or click **OK**.

The Device Manager opens.

- 4 Watch the Device Manager window while connecting a USB cable or another device to the USB port. The window refreshes when Device Manager recognizes the USB connection.
  - If there is activity on Device Manager but none of the previous solutions worked, call Customer Support.
  - If there is no activity on Device Manager, there may be a problem with your computer and its USB support. The computer must recognize the USB connection in order for installation to work.

## Cannot print and there is a firewall on the computer

Third-party (non-Microsoft) firewalls can interfere with wireless printing. If the printer and computer are configured correctly, and the wireless network is working, but the printer will not print wirelessly, then a firewall could be the problem. If there is a firewall (other than the Windows firewall) on the computer, try one or more of the following:

- Update the firewall using the most recent update available from the manufacturer. Refer to the documentation that came with your firewall for instructions on how to do this.
- If programs request firewall access when you install the printer or try to print, make sure you allow those programs to run.
- Temporarily disable the firewall and install the wireless printer on the computer. Re-enable the firewall when you have completed the wireless installation.

## Wi-Fi indicator light is not lit

### CHECK POWER

If the Wi-Fi indicator light is off, make sure the  light is on. If the  light is not on, check the following:

- Make sure the printer is plugged in and turned on.
- Make sure the printer is plugged into a working outlet.
- If the printer is plugged into a power strip, make sure it is turned on and working.

## Wi-Fi indicator light is green but the printer does not print (Windows only)

If you have completed the configuration for wireless printing and all of the settings appear to be correct, but the printer does not print, then try one or more of the following:

### ALLOW THE WIRELESS INSTALLATION TO COMPLETE

Do not attempt to print, remove the installation CD, or detach the installation cable until you see the Wireless Setup Successful screen.

### ENABLE THE PRINTER

Confirm that the printer is enabled:

- 1 Click , or click **Start** and then click **Run**.
- 2 In the Start Search or Run box, type **control printers**.
- 3 Press **Enter**, or click **OK**.  
The printer folder opens.
- 4 Right-click the new printer; from the menu, select **Use Printer Online**.
- 5 Close the Printers or Printers and Faxes window and try printing again.

### SELECT THE WIRELESS PRINTER

You may need to select the wireless printer from your computer to use the printer wirelessly.

- 1 Click , or click **Start** and then click **Run**.
- 2 In the Start Search or Run box, type **control printers**.
- 3 Press **Enter**, or click **OK**.  
The printer folder opens.
- 4 Right-click the printer in the folder with the matching name and model number followed by "(Network)."
- 5 Select **Use Printer Online** from the menu.
- 6 Close the Printers or Printers and Faxes window and try printing again.

### SELECT THE WIRELESS PORT

If you have previously set up your printer as a locally attached printer, then you may need to select the wireless printer to use the printer wirelessly.

- 1 Click , or click **Start** and then click **Run**.
- 2 In the Start Search or Run box, type **control printers**.
- 3 Press **Enter**, or click **OK**.  
The printer folder opens.
- 4 Right-click the printer, and then select **Properties** or **Printer properties** from the menu.
- 5 Click the **Ports** tab.

- 6 Locate the selected port. The selected port has a check beside it in the Port column.
- 7 If the Description column of the selected port indicates that it is a USB port, scroll through the list and select the port with Printer Port in the Description column. Check the printer model in the Printer column to make sure you select the right printer port.
- 8 Click **OK**, and then try to print again.

## Wi-Fi indicator light is still orange

When the Wi-Fi indicator light is orange, it may indicate that the printer is:

- Not configured in infrastructure mode
- Waiting to make an ad hoc connection to another wireless device
- Not connected to a wireless network

The printer may be unable to join the network because of interference, its distance from the wireless access point (wireless router), or until its settings are changed.

These are possible solutions. Try one or more of the following:

### CHECK NETWORK NAME

Make sure your network does not have the same name as another network near you. For example, if you and your neighbor both use a manufacturer's default network name, your printer could be connecting to your neighbor's network.

If you are not using a unique network name, consult the documentation for your wireless access point (wireless router) to learn how to set a network name.

If you set a new network name, you must reset the printer and computer SSID to the same network name.

### CHECK SECURITY KEYS

#### If you are using WEP security

A valid WEP key is:

- Exactly 10 or 26 hexadecimal characters. Hexadecimal characters are A–F, a–f, and 0–9.
- or*
- Exactly 5 or 13 ASCII characters. ASCII characters are letters, numbers, and symbols found on a keyboard.

#### If you are using WPA security

A valid WPA passphrase is:

- From 8 to 63 ASCII characters. ASCII characters in a WPA passphrase are case-sensitive.
- or*
- Exactly 64 hexadecimal characters. Hexadecimal characters are A-F, a-f, and 0-9.

If your wireless network is not using security, then you will not have a security key. Using a wireless network with no security is not recommended because it can allow intruders to use your network resources without your consent.

## **MOVE THE COMPUTER AND/OR PRINTER CLOSER TO THE WIRELESS ACCESS POINT (WIRELESS ROUTER)**

The possible distance between devices in 802.11b or 802.11g networks is 300 feet, while the wireless network range potentially doubles in 802.11n networks. The range of your wireless network depends on many factors, including the abilities of your router and network adapters. If you are having trouble printing, try placing the computer and printer no more than 100 feet apart.

You can find the strength of the network signal on the printer network setup page.

## **CHECK MAC ADDRESS**

If your network uses MAC address filtering, make sure that you include the MAC address of the printer in the MAC address filter list. This will allow the printer to operate on the network.

## **Wi-Fi indicator light is blinking orange during installation**

When the Wi-Fi indicator light is blinking orange, it indicates that the printer has been set up for wireless networking but cannot connect to the network for which it has been configured. The printer may be unable to join the network because of interference, its distance from the access point (wireless router), or until its settings are changed.

These are possible solutions. Try one or more of the following:

### **MAKE SURE THE ACCESS POINT IS ON**

Check the access point and, if necessary, turn it on.

### **MOVE YOUR ACCESS POINT TO MINIMIZE INTERFERENCE**

There may be temporary interference from other devices such as microwave ovens or other appliances, cordless phones, baby monitors, and security system cameras. Make sure your access point is not positioned too closely to these devices.

## **MOVE THE COMPUTER AND/OR PRINTER CLOSER TO THE ACCESS POINT**

The possible distance between devices in 802.11b or 802.11g networks is 300 feet, while the wireless network range potentially doubles in 802.11n networks. The range of your wireless network depends on many factors, including the abilities of your access point and wireless network adapters. If you are having trouble printing, then try placing the computer and printer no more than 100 feet apart.

You can find the signal strength of the network on the network setup page.

## **CHECK YOUR WEP KEY OR WPA PASSPHRASE**

If your access point is using WEP security, then the WEP key should be:

- Exactly 10 or 26 hexadecimal characters. Hexadecimal characters are A–F, a–f, and 0–9.
- or*
- Exactly 5 or 13 ASCII characters. ASCII characters are letters, numbers, and symbols found on a keyboard.

If your access point is using WPA or WPA2 security, then the WPA passphrase should be:

- Exactly 64 hexadecimal characters. Hexadecimal characters are A–F, a–f, and 0–9.
- or*
- From 8 to 63 ASCII characters. ASCII characters are letters, numbers, and symbols found on a keyboard. ASCII characters in a WPA passphrase are case-sensitive.



**Note:** If you do not know this information, then see the documentation that came with the wireless network, or contact the person who set up your wireless network.

## CHECK THE **MAC** ADDRESS

If your network uses MAC address filtering, then make sure that you include the MAC address of the printer in the MAC address filter list. This will allow the printer to operate on the network. For more information, see “How do I find the MAC address?” on page 109.

## PING THE ACCESS POINT TO MAKE SURE THE NETWORK IS WORKING

### For Windows users

- 1 Obtain the IP address of the access point.
  - a Click , or click **Start** and then click **Run**.
  - b In the Start Search or Run box, type **cmd**.
  - c Press **Enter**, or click **OK**.
  - d Type **ipconfig**, and then press **Enter**.
    - The “Default Gateway” entry is typically the access point.
    - The IP address appears as four sets of numbers separated by periods, such as 192.168.2.134.
- 2 Ping the access point:
  - a Click , or click **Start** and then click **Run**.
  - b In the Start Search or Run box, type **cmd**.
  - c Press **Enter**, or click **OK**.
  - d Type **ping** followed by a space and the IP address of the access point. For example:  
**ping 192.168.1.100**
  - e Press **Enter**.
- 3 Check to see whether the access point responds:
  - If the access point responds, then you will see several lines appear that start with “Reply from.” It is possible that the printer did not connect to the wireless network. Turn off and then restart the printer to try to connect again.
  - If the access point does not respond, then “Request timed out.” appears.

Try the following:

  - a Click , or click **Start** and then click **Run**.
  - b In the Start Search or Run box, type **ncpa.cpl**, and then press **Enter**.
  - c Press **Enter** or click **OK**.
  - d Select the appropriate connection from the ones shown.
  - e Right-click the connection, and then click **Repair** or **Diagnose**.

## For Macintosh users

- 1 Make sure AirPort is turned on:

From the Apple menu, navigate to:

**System Preferences > Network**

The AirPort status indicator should be green.

### Notes:

- Yellow means the port is active but not connected.
- Red means the port has not been configured.

- 2 Obtain the IP address of the access point:

- a From the Apple menu, navigate to:

**About This Mac > More Info**

- b From the Contents pane, choose **Network**.

- c From the Active Services list, choose **AirPort**.

The bottom pane lists the details of the AirPort connection.

- d Write down the Router entry.

The Router entry is typically the access point.

- 3 Ping the access point:

- a From the Finder, navigate to:

**Utilities > Network Utility > Ping tab**

- b In the network address field, type the IP address of the access point. For example:

**10.168.1.101**

- c Click **Ping**.

- 4 If the access point responds, then you will see several lines that display the number of bytes received from the access point. This means that your computer is connected to the access point.

If the access point does not respond, then nothing is displayed. You can use Network Diagnostics to help resolve the problem.

## MAKE SURE YOUR COMPUTER CAN COMMUNICATE WITH THE PRINTER

### For Windows users

- 1 Obtain the printer IP address.

- a From the printer, print a network setup page.

For more information, see the *User's Guide*.

- b In the TCP/IP section, look for **Address**.

- 2 Click , or click **Start** and then click **Run**.

- 3 In the Start Search or Run box, type **cmd**.

- 4 Press **Enter**, or click **OK**.

- 5 Type **ping** followed by a space and the IP address of the printer. For example:

**ping 192.168.1.100**

- 6 Press **Enter**.
- 7 If the printer responds, then you will see several lines that display the number of bytes received from the printer. This ensures that your computer is communicating with your printer.  
If the printer does not respond, then “Request timed out.” appears.
  - Your computer might not be connected to the network.
  - You may need to change the settings of your printer. Run the Wireless Setup Utility again.

#### **For Macintosh users**

- 1 Obtain the printer IP address.
  - a From the printer, print a network setup page.  
For more information, see the *User's Guide*.
  - b In the TCP/IP section, look for **Address**.
- 2 From the Finder, navigate to:  
**Utilities > Network Utility > Ping** tab
- 3 Type the IP address of the printer in the network address field. For example:  
**10 . 168 . 1 . 101**
- 4 Click **Ping**.
- 5 If the printer responds, then you will see several lines that display the number of bytes received from the printer. This means that your computer is communicating with your printer.  
If the printer does not respond, then nothing is displayed.
  - Your computer might not be connected to the network. You can use Network Diagnostics to help resolve the problem.
  - You may need to change the settings of your printer. Run the Wireless Setup Assistant again.

#### **CONFIGURE THE PRINTER FOR WIRELESS ACCESS AGAIN**

If your wireless settings have changed, then you must run the printer wireless setup again. The WEP or WPA key, channel, or other network settings may have been manually changed; or the access point may have been reset to factory defaults.

Running the wireless setup again can also resolve issues due to wireless configuration errors.

#### **Notes:**

- If you change network settings, then change them on all the network devices before changing them for the access point.
- If you have already changed the wireless network settings on your access point, then you must change the settings on all the other network devices before you can see them on the network.

#### **For Windows users**

- 1 Click  or **Start**.
- 2 Click **All Programs** or **Programs**, and then select the printer program folder from the list.

3 Navigate to:

**Printer Home** > select your printer > **Settings** tab > **Wireless setup utility**

**Note:** You may be prompted to connect the printer to the computer again using the installation cable as part of the setup process.

4 Follow the instructions on the computer screen.

#### **For Macintosh users**

1 From the Applications folder in the Finder, or from the Finder desktop, double-click the printer folder.

2 Double-click **Wireless Setup Assistant**.

3 Follow the instructions on the computer screen.

## **Wireless print server not installed**

You may see a message during installation indicating that the printer does not have a wireless print server installed. If you are sure the printer is capable of wireless printing, try the following:

### **CHECK POWER**

Make sure the  light is on.

## **“Communication not available” message displays when printing wirelessly**

These are possible solutions. Try one or more of the following:

### **MAKE SURE YOUR COMPUTER AND PRINTER HAVE VALID IP ADDRESSES FOR THE NETWORK**

If you are using a laptop and have power saving settings enabled, you may see the “Communication not available” message on your computer screen when you attempt to print wirelessly. This can occur if the laptop hard drive has powered down.

If you see this message, wait a few seconds and then try to print again. The laptop and printer require a few seconds to power up again and reattach to the wireless network.

If you see this message again after you have waited long enough for the printer and the laptop to attach to the network, there may be a problem with your wireless network.

Make sure that the laptop and printer have both received IP addresses:

#### **For Windows users**

1 Click , or click **Start** and then click **Run**.

2 In the Start Search or Run box, type **cmd**.

3 Press **Enter**, or click **OK**.

The Command Prompt window opens.

4 Type **ipconfig**, and then press **Enter**.

The IP address appears as four sets of numbers separated by periods, such as 192.168.0.100.



## For Macintosh users

- 1 From the Apple menu, choose **About This Mac**.
- 2 Click **More Info**.
- 3 From the Contents pane, choose **Network**.
- 4 If you are connected over a wireless network, choose **AirPort** from the Active Services list.

## How to locate a printer IP address

- You can locate the printer IP address by viewing the printer network setup page.

If the printer and/or the laptop does not have an IP address, or if either has an address of 169.254.x.y (where x and y are any two numbers between 0 and 255):

- 1 Turn off the device that does not have a valid IP address (the laptop, the printer, or both).
- 2 Turn on the device(s).
- 3 Check the IP addresses again.

If the laptop and/or printer still does not receive a valid IP address, there is a problem with your wireless network. Try the following:

- Make sure your wireless access point (wireless router) is turned on and is working.
- Remove any objects that could be blocking the signal.
- Temporarily turn off any unnecessary wireless devices on your network and pause any network-intensive activities, like large file transfers or network games. If the network is too busy, it is possible that the printer is not receiving the IP address within the allowed time.
- Make sure your DHCP server, which may also be your wireless router, is working and is configured to assign IP addresses. If you are not sure how to do this, refer to the manual that came with your wireless router for more information.

If the printer and computer have valid IP addresses and the network is operating correctly, continue troubleshooting.

## MAKE SURE THE WIRELESS PORT IS SELECTED

**Note:** This solution applies to Windows users only

- 1 Click , or click **Start** and then click **Run**.
- 2 In the Start Search or Run box, type **control printers**.
- 3 Press **Enter**, or click **OK**.  
The printer folder opens.
- 4 Right-click the printer, and then select **Properties** or **Printer properties** from the menu.
- 5 Click the **Ports** tab.
- 6 Locate the selected port. The selected port has a check beside it in the Port column.
- 7 If the Description column of the selected port indicates that it is a USB port, scroll through the list and select the port with Printer Port in the Description column. Check the printer model in the Printer column to make sure you select the right printer port.
- 8 Click **OK**, and then try to print again.

## MAKE SURE BIDIRECTIONAL COMMUNICATION IS ENABLED

**Note:** This solution applies to Windows users only

- 1 Click , or click **Start** and then click **Run**.
- 2 In the Start Search or Run box, type **control printers**.
- 3 Press **Enter**, or click **OK**.  
The printer folder opens.
- 4 Right-click the printer, and then select **Properties** or **Printer properties** from the menu.
- 5 Click the **Ports** tab.
- 6 Click the box next to **Enable bidirectional support** if it is not already checked.
- 7 Click **Apply**.
- 8 Click **OK**, and then try to print again.

## Communication with printer lost when connected to Virtual Private Network (VPN)

You will lose your connection to a wireless printer on your local network when connected to most *Virtual Private Networks* (VPNs). Most VPNs allow users to communicate with only the VPN and no other network at the same time. If you would like to have the ability to connect to your local network and to a VPN at the same time, the system support person for the VPN must enable split tunneling. Be aware that some organizations will not allow split tunneling due to security or technical concerns.

## Resolving intermittent wireless communications issues

You may notice that your printer works for a short time and then stops working, although apparently nothing has changed on your wireless network.

Many different issues can interrupt network communications, and sometimes more than one problem exists at the same time. These are possible solutions. Try one or more of the following:

### DISCONNECT FROM ALL VPNS WHEN ATTEMPTING TO USE THE WIRELESS NETWORK

Most Virtual Private Networks (VPNs) allow computers to communicate with only the VPN and no other network at the same time. Disconnect from the VPN before installing the driver on the computer or before running the wireless setup on the computer.

To check if the computer is currently connected to a VPN, open your VPN Client software and check your VPN connections. If you do not have a VPN Client software installed, check the connections manually using the Windows VPN Client.

If you would like to have the ability to connect to your local network and to a VPN at the same time, the system support person for the VPN must enable split tunneling. Be aware that some organizations will not allow split tunneling due to security or technical concerns.

### TURN OFF THE WIRELESS ACCESS POINT (WIRELESS ROUTER) AND TURN IT BACK ON AGAIN

## ELIMINATE NETWORK CONGESTION

If a wireless network is too busy, the computer and printer may have difficulty communicating with each other. Some causes of wireless network congestion can include:

- Transferring large files across the network
- Networked games
- Peer-to-peer file swapping applications
- Streaming video
- Too many computers on the wireless network at once

## ELIMINATE SOURCES OF INTERFERENCE

Common household items can potentially disrupt wireless network communications. Cordless phones (but not cellular phones), microwave ovens, baby monitors, almost any kitchen appliance, wireless surveillance equipment, nearby wireless networks, and any appliance containing a motor can disrupt wireless network communications.

Try turning on any potential sources of interference and see if it causes the problem. If it does, separate your wireless network from the device.

## CHANGE THE CHANNEL THE WIRELESS ROUTER USES

You can sometimes eliminate interference from unknown sources by changing the channel your wireless router uses to broadcast. There are three distinct channels on a router. Check the documentation that came with your router to determine which three apply. Other channels are offered as options, but these overlap. If the router is configured to use the default settings, change the channel setting to use a different distinct channel. Refer to the manual that came with your wireless router if you are not sure how to change the channel.

## CONFIGURE THE WIRELESS ROUTER WITH A UNIQUE SSID

Many wireless networks use the SSID that the router was originally configured by the manufacturer to use. Using the default SSID can cause problems when more than one network is operating in the same area with the same SSID. The printer or computer may attempt to attach to the wrong network, although it will appear to be trying to connect to the correct network.

To avoid this type of interference, change the SSID on your wireless router from the default. Refer to the manual that came with your router if you are not sure how to change the SSID.

**Note:** You must change the SSID on all of the other devices that access your wireless network if you change the SSID on the router.

## ASSIGN STATIC IP ADDRESSES TO ALL DEVICES IN THE NETWORK

Most wireless networks use a DHCP server (dynamic host configuration protocol) built in to the wireless router to assign IP addresses to clients on the wireless network. DHCP addresses are assigned when they are needed, as when a new device is added to the wireless network or when it is powered on. Wireless devices must send a request to the router, and receive an IP address in response so they can function on the network. Because the router performs many other tasks besides assigning addresses, it sometimes does not respond quickly enough with an address. The requesting device sometimes gives up before it receives an address.

Try assigning static IP addresses to the devices in your network to resolve this issue. Static IP addresses cut down on the work your wireless router has to do. Refer to the manual that came with your router and your operating system documentation if you are not sure how to assign static IP addresses.

To assign a static IP address to the printer, do the following:

- 1 Complete the wireless setup, allowing the printer to receive a DHCP address from a DHCP server on the network.
- 2 Print a network setup page to see what IP address is currently assigned to the printer.
- 3 Open a Web browser and then type the printer IP address in the address field. Press **Enter**.  
The printer Web page loads.
- 4 Click the **Configuration** link.
- 5 Click the **TCP/IP** link.
- 6 Click the **Set Static IP Address** link.
- 7 Type the IP address you want to assign to the printer in the **IP Address** field.
- 8 Click the **Submit** button.

The Submitting Selection message appears.

Confirm that the IP address is updated by typing the static IP address in the browser address field and checking to see if the printer Web page reloads.

## CHECK FOR KNOWN ISSUES WITH THE WIRELESS ROUTER

Some wireless routers have documented defects that were identified and resolved by the manufacturers. Visit the company Web site of the router manufacturer. Check for firmware updates and other advice from the manufacturer. Check the manual that came with your wireless router if you are not sure how to reach the manufacturer Web site.

## CHECK FOR WIRELESS ADAPTER UPDATES

If you are having trouble printing from one particular computer, check the Web site of the manufacturer of the network adapter card in that computer. It is possible that there is an updated driver available that could resolve the issue.

## CHANGE ALL NETWORK DEVICES TO THE SAME TYPE

While it is possible to successfully mix 802.11b, 802.11g, and 802.11n devices on the same wireless network, the faster devices will sometimes prevent the slower devices from communicating. Wireless devices are designed to wait for a gap in wireless network communications before attempting to send information. If newer, faster devices are constantly using the wireless network, then older, slower devices will not have a chance to send data.

Try only turning on the network devices of the same type and see if network communications improve. If this solves the problem, you may want to upgrade your older devices with newer network adapters.

## PURCHASE A NEW ROUTER

If your router is several years old, it may not be fully compatible with the newer wireless devices on your network. Consider purchasing a newer router that is fully compliant with the 802.11 IEEE specifications.

# Notices

## Product information

Product name:

Lexmark S400 Series

Machine type:

4443

Model(s):

201, 20E, 21n, 2En

## Edition notice

November 2010

**The following paragraph does not apply to any country where such provisions are inconsistent with local law:**

LEXMARK INTERNATIONAL, INC., PROVIDES THIS PUBLICATION "AS IS" WITHOUT WARRANTY OF ANY KIND, EITHER EXPRESS OR IMPLIED, INCLUDING, BUT NOT LIMITED TO, THE IMPLIED WARRANTIES OF MERCHANTABILITY OR FITNESS FOR A PARTICULAR PURPOSE. Some states do not allow disclaimer of express or implied warranties in certain transactions; therefore, this statement may not apply to you.

This publication could include technical inaccuracies or typographical errors. Changes are periodically made to the information herein; these changes will be incorporated in later editions. Improvements or changes in the products or the programs described may be made at any time.

References in this publication to products, programs, or services do not imply that the manufacturer intends to make these available in all countries in which it operates. Any reference to a product, program, or service is not intended to state or imply that only that product, program, or service may be used. Any functionally equivalent product, program, or service that does not infringe any existing intellectual property right may be used instead. Evaluation and verification of operation in conjunction with other products, programs, or services, except those expressly designated by the manufacturer, are the user's responsibility.

For Lexmark technical support, visit [support.lexmark.com](http://support.lexmark.com).

For information on supplies and downloads, visit [www.lexmark.com](http://www.lexmark.com).

If you don't have access to the Internet, you can contact Lexmark by mail:

Lexmark International, Inc.  
Bldg 004-2/CSC  
740 New Circle Road NW  
Lexington, KY 40550  
USA

© 2010 Lexmark International, Inc.

All rights reserved.

## UNITED STATES GOVERNMENT RIGHTS

This software and any accompanying documentation provided under this agreement are commercial computer software and documentation developed exclusively at private expense.

## Trademarks

Lexmark and Lexmark with diamond design are trademarks of Lexmark International, Inc., registered in the United States and/or other countries.

PerfectFinish is a trademark of Lexmark International, Inc.

Mac and the Mac logo are trademarks of Apple Inc., registered in the U.S. and other countries.

All other trademarks are the property of their respective owners.

## Licensing notices

All licensing notices associated with this product can be viewed from the CD:\LEGAL directory of the installation software CD.

## Federal Communications Commission (FCC) compliance information statement

This product has been tested and found to comply with the limits for a Class B digital device, pursuant to Part 15 of the FCC Rules. Operation is subject to the following two conditions: (1) this device may not cause harmful interference, and (2) this device must accept any interference received, including interference that may cause undesired operation.

The FCC Class B limits are designed to provide reasonable protection against harmful interference when the equipment is operated in a residential installation. This equipment generates, uses, and can radiate radio frequency energy and, if not installed and used in accordance with the instructions, may cause harmful interference to radio communications. However, there is no guarantee that interference will not occur in a particular installation. If this equipment does cause harmful interference to radio or television reception, which can be determined by turning the equipment off and on, the user is encouraged to try to correct the interference by one or more of the following measures:

- Reorient or relocate the receiving antenna.
- Increase the separation between the equipment and receiver.
- Connect the equipment into an outlet on a circuit different from that to which the receiver is connected.
- Consult your point of purchase or service representative for additional suggestions.

The manufacturer is not responsible for radio or television interference caused by using other than recommended cables or by unauthorized changes or modifications to this equipment. Unauthorized changes or modifications could void the user's authority to operate this equipment.

**Note:** To assure compliance with FCC regulations on electromagnetic interference for a Class B computing device, use a properly shielded and grounded cable such as Lexmark part number 1021294 for USB attach. Use of a substitute cable not properly shielded and grounded may result in a violation of FCC regulations.

Any questions regarding this compliance information statement should be directed to:

Director of Lexmark Technology & Services  
Lexmark International, Inc.  
740 West New Circle Road  
Lexington, KY 40550  
(859) 232-3000

## Hinweis zum GS-Zeichen

Modell	201, 20E, 21n, 2En
Gerätetyp	4443
Postanschrift	Lexmark Deutschland GmbH Postfach 1560 63115 Dietzenbach
Adresse	Lexmark Deutschland GmbH Max-Planck-Straße 12 63128 Dietzenbach
Telefon	0180 - 564 56 44 (Produktinformationen)
Telefon	01805- 51 25 11 (Technischer Kundendienst)
E-mail	internet@lexmark.de

## Noise emission levels

The following measurements were made in accordance with ISO 7779 and reported in conformance with ISO 9296.

**Note:** Some modes may not apply to your product.

1-meter average sound pressure, dBA	
Printing	50 dBA
Scanning	47 dBA
Copying	47 dBA
Ready	inaudible

Values are subject to change. See [www.lexmark.com](http://www.lexmark.com) for current values.

## Temperature information

Ambient temperature	15–32° C (60–90° F)
Shipping temperature	-40–60° C (-40–140° F)
Storage temperature	1–60° C (34–140° F)

## Waste from Electrical and Electronic Equipment (WEEE) directive



The WEEE logo signifies specific recycling programs and procedures for electronic products in countries of the European Union. We encourage the recycling of our products. If you have further questions about recycling options, visit the Lexmark Web site at [www.lexmark.com](http://www.lexmark.com) for your local sales office phone number.

## Product disposal

Do not dispose of the printer or supplies in the same manner as normal household waste. Consult your local authorities for disposal and recycling options.

## Battery notice

This product contains Perchlorate material. Special handling may apply. For more information, go to <http://www.dtsc.ca.gov/hazardouswaste/perchlorate/>.

## ENERGY STAR

Any Lexmark product bearing the ENERGY STAR emblem on the product or on a start-up screen is certified to comply with Environmental Protection Agency (EPA) ENERGY STAR requirements as configured when shipped by Lexmark.



## Power consumption

### Product power consumption

The following table documents the power consumption characteristics of the product.

**Note:** Some modes may not apply to your product.



Mode	Description	Power consumption (Watts)
Printing	The product is generating hard-copy output from electronic inputs.	16.23
Copying	The product is generating hard-copy output from hard-copy original documents.	10.74
Scanning	The product is scanning hard-copy documents.	9.57
Ready	The product is waiting for a print job.	7.78
Power Saver	The product is in energy-saving mode.	3.37
Off	The product is plugged into a wall outlet, but the power switch is turned off.	0.37

The power consumption levels listed in the previous table represent time-averaged measurements. Instantaneous power draws may be substantially higher than the average.

Values are subject to change. See [www.lexmark.com](http://www.lexmark.com) for current values.

### Power Saver

This product is designed with an energy-saving mode called Power Saver. The Power Saver Mode is equivalent to the Sleep Mode. The Power Saver Mode saves energy by lowering power consumption during extended periods of inactivity. The Power Saver Mode is automatically engaged after this product is not used for a specified period of time, called the Power Saver Timeout.

Factory default Power Saver Timeout for this product (in minutes):	10
--	----

By using the configuration menus, the Power Saver Timeout can be modified between 1 minute and 240 minutes. Setting the Power Saver Timeout to a low value reduces energy consumption, but may increase the response time of the product. Setting the Power Saver Timeout to a high value maintains a fast response, but uses more energy.

### Off mode

If this product has an off mode which still consumes a small amount of power, then to completely stop product power consumption, disconnect the power supply cord from the wall outlet.

### Total energy usage

It is sometimes helpful to calculate the total product energy usage. Since power consumption claims are provided in power units of Watts, the power consumption should be multiplied by the time the product spends in each mode in order to calculate energy usage. The total product energy usage is the sum of each mode's energy usage.

## LEXMARK SOFTWARE LIMITED WARRANTY AND LICENSE AGREEMENTS

PLEASE READ CAREFULLY BEFORE USING THIS PRODUCT: BY USING THIS PRODUCT, YOU AGREE TO BE BOUND BY ALL THE TERMS AND CONDITIONS OF THIS SOFTWARE LIMITED WARRANTY AND LICENSE AGREEMENTS. IF YOU DO NOT AGREE WITH THE TERMS OF THIS SOFTWARE LIMITED WARRANTY AND LICENSE AGREEMENTS, PROMPTLY RETURN THE PRODUCT UNUSED AND REQUEST A REFUND OF THE AMOUNT YOU PAID. IF YOU ARE INSTALLING THIS PRODUCT FOR USE BY OTHER PARTIES, YOU AGREE TO INFORM THE USERS THAT USE OF THE PRODUCT INDICATES ACCEPTANCE OF THESE TERMS.

## PRINTER LICENSE AGREEMENT

I agree that this patented printer is licensed for, and designed to work with only genuine Lexmark ink cartridges for the life of the patented printer. I agree to: (1) use only genuine Lexmark ink cartridges with this printer (except I may use replacement cartridges made by Lexmark but sold without single use terms as described in the below cartridge license agreement), and (2) pass this printer license/agreement to any subsequent user of this printer.

## CARTRIDGE LICENSE AGREEMENT\*

I agree that the patented print cartridge(s) shipped with this printing device are sold subject to the following license/agreement: The patented print cartridge(s) contained inside is/are licensed for a single use only and is/are designed to stop working after delivering a fixed amount of ink. A variable amount of ink will remain in the cartridge when replacement is required. After this single use, the license to use the print cartridge terminates, and the used cartridge must be returned only to Lexmark for remanufacturing, refilling or recycling. If I buy another cartridge in the future that is sold subject to the above terms, I accept such terms as to that cartridge. If you do not accept the terms of this single use license/agreement; return this product in its original packaging to your point of purchase. A replacement cartridge sold without these terms is available at [www.lexmark.com](http://www.lexmark.com).

## LEXMARK SOFTWARE LICENSE AGREEMENT

This Software License Agreement ("License Agreement") is a legal agreement between you (either an individual or a single entity) and Lexmark International, Inc. ("Lexmark") that, to the extent your Lexmark product or Software Program is not otherwise subject to a written software license agreement between you and Lexmark or its suppliers, governs your use of any Software Program installed on or provided by Lexmark for use in connection with your Lexmark product. The term "Software Program" includes machine-readable instructions, audio/visual content (such as images and recordings), and associated media, printed materials and electronic documentation, whether incorporated into, distributed with or for use with your Lexmark product.

- 1 STATEMENT OF SOFTWARE LIMITED WARRANTY.** Lexmark warrants that the media (e.g., diskette or compact disk) on which the Software Program (if any) is furnished is free from defects in materials and workmanship under normal use during the warranty period. The warranty period is ninety (90) days and commences on the date the Software Program is delivered to the original end-user. This limited warranty applies only to Software Program media purchased new from Lexmark or an Authorized Lexmark Reseller or Distributor. Lexmark will replace the Software Program should it be determined that the media does not conform to this limited warranty.
- 2 DISCLAIMER AND LIMITATION OF WARRANTIES.** EXCEPT AS PROVIDED IN THIS SOFTWARE LICENSE AGREEMENT AND TO THE MAXIMUM EXTENT PERMITTED BY APPLICABLE LAW, LEXMARK AND ITS SUPPLIERS PROVIDE THE SOFTWARE PROGRAM "AS IS" AND HEREBY DISCLAIM ALL OTHER WARRANTIES AND CONDITIONS, EITHER EXPRESS OR IMPLIED, INCLUDING, BUT NOT LIMITED TO, TITLE, NON-INFRINGEMENT, MERCHANTABILITY AND FITNESS FOR A PARTICULAR PURPOSE, AND ABSENCE OF VIRUSES, ALL WITH REGARD TO THE SOFTWARE PROGRAM. TO THE EXTENT LEXMARK CANNOT BY LAW DISCLAIM ANY COMPONENT OF THE IMPLIED WARRANTIES OF MERCHANTABILITY OR FITNESS FOR A PARTICULAR PURPOSE, LEXMARK LIMITS THE DURATION OF SUCH WARRANTIES TO THE 90-DAY TERM OF THE EXPRESS SOFTWARE LIMITED WARRANTY. This Agreement is to be read in conjunction with certain statutory provisions, as that may be in force from time to time, that imply warranties or conditions or impose obligations on Lexmark that cannot be excluded or modified. If any such provisions apply, then to the extent Lexmark is able, Lexmark hereby limits its liability for breach of those provisions to one of the following: providing you a replacement copy of the Software Program or reimbursement of the price paid for the Software Program.

The Software Program may include internet links to other software applications and/or internet web pages hosted and operated by third parties unaffiliated with Lexmark. You acknowledge and agree that Lexmark is not responsible in any way for the hosting, performance, operation, maintenance, or content of, such software applications and/or internet web pages.

**3 LIMITATION OF REMEDY.** TO THE MAXIMUM EXTENT PERMITTED BY APPLICABLE LAW, ANY AND ALL LIABILITY OF LEXMARK UNDER THIS SOFTWARE LICENSE AGREEMENT IS EXPRESSLY LIMITED TO THE GREATER OF THE PRICE PAID FOR THE SOFTWARE PROGRAM AND FIVE U.S. DOLLARS (OR THE EQUIVALENT IN LOCAL CURRENCY). YOUR SOLE REMEDY AGAINST LEXMARK IN ANY DISPUTE UNDER THIS SOFTWARE LICENSE AGREEMENT SHALL BE TO SEEK TO RECOVER ONE OF THESE AMOUNTS, UPON PAYMENT OF WHICH LEXMARK SHALL BE RELEASED AND DISCHARGED OF ALL FURTHER OBLIGATIONS AND LIABILITY TO YOU.

IN NO EVENT WILL LEXMARK, ITS SUPPLIERS, SUBSIDIARIES, OR RESELLERS BE LIABLE FOR ANY SPECIAL, INCIDENTAL, INDIRECT, EXEMPLARY, PUNITIVE, OR CONSEQUENTIAL DAMAGES (INCLUDING BUT NOT LIMITED TO LOST PROFITS OR REVENUES, LOST SAVINGS, INTERRUPTION OF USE OR ANY LOSS OF, INACCURACY IN, OR DAMAGE TO, DATA OR RECORDS, FOR CLAIMS OF THIRD PARTIES, OR DAMAGE TO REAL OR TANGIBLE PROPERTY, FOR LOSS OF PRIVACY ARISING OUT OR IN ANY WAY RELATED TO THE USE OF OR INABILITY TO USE THE SOFTWARE PROGRAM, OR OTHERWISE IN CONNECTION WITH ANY PROVISION OF THIS SOFTWARE LICENCE AGREEMENT), REGARDLESS OF THE NATURE OF THE CLAIM, INCLUDING BUT NOT LIMITED TO BREACH OF WARRANTY OR CONTRACT, TORT (INCLUDING NEGLIGENCE OR STRICT LIABILITY), AND EVEN IF LEXMARK, OR ITS SUPPLIERS, AFFILIATES, OR REMARKETERS HAVE BEEN ADVISED OF THE POSSIBILITY OF SUCH DAMAGES, OR FOR ANY CLAIM BY YOU BASED ON A THIRD-PARTY CLAIM, EXCEPT TO THE EXTENT THIS EXCLUSION OF DAMAGES IS DETERMINED LEGALLY INVALID. THE FOREGOING LIMITATIONS APPLY EVEN IF THE ABOVE-STATED REMEDIES FAIL OF THEIR ESSENTIAL PURPOSE.

**4 U.S.A. STATE LAWS.** This Software Limited Warranty gives you specific legal rights. You may also have other rights that vary from state to state. Some states do not allow limitations on how long an implied warranty lasts or the exclusion of limitation of incidental or consequential damages, so the above limitations may not apply to you.

**5 LICENSE GRANT.** Lexmark grants you the following rights provided you comply with all terms and conditions of this License Agreement:

**a Use.** You may Use one (1) copy of the Software Program. The term “Use” means storing, loading, installing, executing, or displaying the Software Program. If Lexmark has licensed the Software Program to you for concurrent use, you must limit the number of authorized users to the number specified in your agreement with Lexmark. You may not separate the components of the Software Program for use on more than one computer. You agree that you will not Use the Software Program, in whole or in part, in any manner that has the effect of overriding, modifying, eliminating, obscuring, altering or de-emphasizing the visual appearance of any trademark, trade name, trade dress or intellectual property notice that appears on any computer display screens normally generated by, or as a result of, the Software Program.

**b Copying.** You may make one (1) copy of the Software Program solely for purposes of backup, archiving, or installation, provided the copy contains all of the original Software Program’s proprietary notices. You may not copy the Software Program to any public or distributed network.

**c Reservation of Rights.** The Software Program, including all fonts, is copyrighted and owned by Lexmark International, Inc. and/or its suppliers. Lexmark reserves all rights not expressly granted to you in this License Agreement.

**d Freeware.** Notwithstanding the terms and conditions of this License Agreement, all or any portion of the Software Program that constitutes software provided under public license by third parties (“Freeware”) is licensed to you subject to the terms and conditions of the software license agreement accompanying such Freeware, whether in the form of a discrete agreement, shrink-wrap license, or electronic license terms at the time of download. Use of the Freeware by you shall be governed entirely by the terms and conditions of such license.

**6 TRANSFER.** You may transfer the Software Program to another end-user. Any transfer must include all software components, media, printed materials, and this License Agreement and you may not retain copies of the Software Program or components thereof. The transfer may not be an indirect transfer, such as a consignment. Prior to the transfer, the end-user receiving the transferred Software Program must agree to all these License Agreement terms. Upon transfer of the Software Program, your license is automatically terminated. You may not rent, sublicense, or assign the Software Program except to the extent provided in this License Agreement, and any attempt to do so shall be void.

- 7 UPGRADES.** To Use a Software Program identified as an upgrade, you must first be licensed to the original Software Program identified by Lexmark as eligible for the upgrade. After upgrading, you may no longer use the original Software Program that formed the basis for your upgrade eligibility.
- 8 LIMITATION ON REVERSE ENGINEERING.** You may not alter, decrypt, reverse engineer, reverse assemble, reverse compile or otherwise translate the Software Program, except as and to the extent expressly permitted to do so by applicable law for the purposes of inter-operability, error correction, and security testing. If you have such statutory rights, you will notify Lexmark in writing of any intended reverse engineering, reverse assembly, or reverse compilation. You may not decrypt the Software Program unless necessary for the legitimate Use of the Software Program.
- 9 ADDITIONAL SOFTWARE.** This License Agreement applies to updates or supplements to the original Software Program provided by Lexmark unless Lexmark provides other terms along with the update or supplement.
- 10 TERM.** This License Agreement is effective unless terminated or rejected. You may reject or terminate this license at any time by destroying all copies of the Software Program, together with all modifications, documentation, and merged portions in any form, or as otherwise described herein. Lexmark may terminate your license upon notice if you fail to comply with any of the terms of this License Agreement. Upon such termination, you agree to destroy all copies of the Software Program together with all modifications, documentation, and merged portions in any form.
- 11 TAXES.** You agree that you are responsible for payment of any taxes including, without limitation, any goods and services and personal property taxes, resulting from this Agreement or your Use of the Software Program.
- 12 LIMITATION ON ACTIONS.** No action, regardless of form, arising out of this Agreement may be brought by either party more than two years after the cause of action has arisen, except as provided under applicable law.
- 13 APPLICABLE LAW.** This Agreement is governed by the laws of the Commonwealth of Kentucky, United States of America. No choice of law rules in any jurisdiction shall apply. The UN Convention on Contracts for the International Sale of Goods shall not apply.
- 14 UNITED STATES GOVERNMENT RESTRICTED RIGHTS.** The Software Program has been developed entirely at private expense. Rights of the United States Government to use the Software Program is as set forth in this Agreement and as restricted in DFARS 252.227-7014 and in similar FAR provisions (or any equivalent agency regulation or contract clause).
- 15 CONSENT TO USE OF DATA.** You agree that Lexmark, its affiliates, and agents may collect and use information you provide in relation to support services performed with respect to the Software Program and requested by you. Lexmark agrees not to use this information in a form that personally identifies you except to the extent necessary to provide such services.
- 16 EXPORT RESTRICTIONS.** You may not (a) acquire, ship, transfer, or reexport, directly or indirectly, the Software Program or any direct product therefrom, in violation of any applicable export laws or (b) permit the Software Program to be used for any purpose prohibited by such export laws, including, without limitation, nuclear, chemical, or biological weapons proliferation.
- 17 AGREEMENT TO CONTRACT ELECTRONICALLY.** You and Lexmark agree to form this License Agreement electronically. This means that when you click the “Agree” or “Yes” button on this page or use this product, you acknowledge your agreement to these License Agreement terms and conditions and that you are doing so with the intent to “sign” a contract with Lexmark.
- 18 CAPACITY AND AUTHORITY TO CONTRACT.** You represent that you are of the legal age of majority in the place you sign this License Agreement and, if applicable, you are duly authorized by your employer or principal to enter into this contract.
- 19 ENTIRE AGREEMENT.** This License Agreement (including any addendum or amendment to this License Agreement that is included with the Software Program) is the entire agreement between you and Lexmark relating to the Software Program. Except as otherwise provided for herein, these terms and conditions supersede all prior or contemporaneous oral or written communications, proposals, and representations with respect to the Software Program or any other subject matter covered by this License Agreement (except to the extent such extraneous terms do not conflict with the terms of this License Agreement, any other written agreement signed by you and

Lexmark relating to your Use of the Software Program). To the extent any Lexmark policies or programs for support services conflict with the terms of this License Agreement, the terms of this License Agreement shall control.

\* Products within the XX90 Series (including but not limited to models Z2390, Z2490, X2690, X3690, and X4690) are not subject to the Cartridge License Agreement. This Cartridge License Agreement does not apply to cartridges included within the printer boxes of XX75 Series products (including but not limited to models X4975 and X7675). It applies to replacement cartridges that are sold subject to these terms and conditions, however. Replacement cartridges sold without these terms are available through [www.lexmark.com](http://www.lexmark.com).

### **MICROSOFT CORPORATION NOTICES**

- 1 This product may incorporate intellectual property owned by Microsoft Corporation. The terms and conditions upon which Microsoft is licensing such intellectual property may be found at <http://go.microsoft.com/fwlink/?LinkId=52369>.
- 2 This product is based on Microsoft Print Schema technology. You may find the terms and conditions upon which Microsoft is licensing such intellectual property at <http://go.microsoft.com/fwlink/?LinkId=83288>.

### **ADOBE SYSTEMS INCORPORATED NOTICE**

Contains Flash®, Flash® Lite™ and/or Reader® technology by Adobe Systems Incorporated

This Product contains Adobe® Flash® player software under license from Adobe Systems Incorporated, Copyright © 1995-2007 Adobe Macromedia Software LLC. All rights reserved. Adobe, Reader and Flash are trademarks of Adobe Systems Incorporated.

### **European Community (EC) directives conformity**

This product is in conformity with the protection requirements of EC Council directives 2004/108/EC, 2006/95/EC, and 1999/5/EC on the approximation and harmonization of the laws of the Member States relating to electromagnetic compatibility and safety of electrical equipment designed for use within certain voltage limits and on radio equipment and telecommunications terminal equipment.

The manufacturer of this product is: Lexmark International, Inc., 740 West New Circle Road, Lexington, KY, 40550 USA. The authorized representative is: Lexmark International Technology Hungária Kft., 8 Lechner Ödön fasor, Millennium Tower III, 1095 Budapest HUNGARY, A declaration of conformity to the requirements of the Directives is available upon request from the Authorized Representative.

This product satisfies the Class B limits of EN 55022 and safety requirements of EN 60950.

### **Industry Canada compliance statement**

This Class B digital apparatus meets all requirements of the Canadian Interference-Causing Equipment Standard ICES-003.

### **Avis de conformité aux normes de l'industrie du Canada**

Cet appareil numérique de classe B est conforme aux exigences de la norme canadienne relative aux équipements pouvant causer des interférences NMB-003.

## Regulatory notices for telecommunication terminal equipment

This section contains regulatory information pertaining to products that contain telecommunication terminal equipment such as facsimile.

### Notice to users of the US telephone network: FCC requirements

This equipment complies with Part 68 of the FCC rules and the requirements adopted by the Administrative Council for Terminal Attachments (ACTA). On the back of this equipment is a label that contains, among other information, a product identifier in the format US:AAAEQ##TXXXX. If requested, this number must be provided to your telephone company.

This equipment uses the RJ-11C Universal Service Order Code (USOC) jack.

A plug and jack used to connect this equipment to the premises' wiring and telephone network must comply with the applicable FCC Part 68 rules and requirements adopted by the ACTA. A compliant telephone cord and modular plug is provided with this product. It is designed to be connected to a compatible modular jack that is also compliant. See your setup documentation for more information.

The Ringer Equivalence Number (REN) is used to determine the number of devices that may be connected to a telephone line. Excessive RENs on a telephone line may result in the devices not ringing in response to an incoming call. In most but not all areas, the sum of RENs should not exceed five (5.0). To be certain of the number of devices that may be connected to a line, as determined by the total RENs, contact your local telephone company. For products approved after July 23, 2001, the REN for this product is part of the product identifier that has the format US:AAAEQ##TXXXX. The digits represented by ## are the REN without a decimal point (for example, 03 is a REN of 0.3). For earlier products, the REN is shown separately on the label.

If this equipment causes harm to the telephone network, the telephone company will notify you in advance that temporary discontinuance of service may be required. If advance notice is not practical, the telephone company will notify the customer as soon as possible. You will also be advised of your right to file a complaint with the FCC.

The telephone company may make changes in its facilities, equipment, operations or procedures that could affect the operation of this equipment. If this happens, the telephone company will provide advance notice in order for you to make necessary modifications to maintain uninterrupted service.

If you experience trouble with this equipment, for repair or warranty information, contact Lexmark International, Inc. at [www.lexmark.com](http://www.lexmark.com) or your Lexmark representative. If the equipment is causing harm to the telephone network, the telephone company may request that you disconnect the equipment until the problem is resolved.

This equipment contains no user serviceable parts. For repair and warranty information, contact Lexmark International, Inc. See the previous paragraph for contact information.

Connection to party line service is subject to state tariffs. Contact the state public utility commission, public service commission, or corporation commission for information.

If your home has specially wired alarm equipment connected to the telephone line, ensure the installation of this equipment does not disable your alarm equipment. If you have questions about what will disable alarm equipment, consult your telephone company or a qualified installer.

Telephone companies report that electrical surges, typically lightning transients, are very destructive to customer terminal equipment connected to AC power sources. This has been identified as a major nationwide problem. It is recommended that the customer install an appropriate AC surge arrester in the AC outlet to which this device is connected. An appropriate AC surge arrester is defined as one that is suitably rated, and certified by UL (Underwriter's Laboratories), another NRTL (Nationally Recognized Testing Laboratory), or a recognized safety certification body in the country/region of use. This is to avoid damage to the equipment caused by local lightning strikes and other electrical surges.

The Telephone Consumer Protection Act of 1991 makes it unlawful for any person to use a computer or other electronic device, including fax machines, to send any message unless said message clearly contains in a margin at the top or bottom of each transmitted page or on the first page of the transmission, the date and time it is sent and an identification of the business or other entity, or other individual sending the message, and the telephone number of the sending machine or such business, other entity, or individual. (The telephone number provided may not be a 900 number or any other number for which charges exceed local or long-distance transmission charges.)

See your user documentation in order to program this information into your fax machine.

## **South Africa telecommunications notice**

This modem must be used in conjunction with an approved surge protection device when connected to the PSTN.

## **Notice to users of the Canadian telephone network**

This product meets the applicable Industry Canada technical specifications. The Ringer Equivalence Number (REN) is an indication of the maximum number of terminals allowed to be connected to a telephone interface. The terminus of an interface may consist of any combination of devices, subject only to the requirement that the sum of the RENs of all the devices does not exceed five. The modem REN is located on the rear of the equipment on the product labeling.

Telephone companies report that electrical surges, typically lightning transients, are very destructive to customer terminal equipment connected to AC power sources. This has been identified as a major nationwide problem. It is recommended that the customer install an appropriate AC surge arrester in the AC outlet to which this device is connected. An appropriate AC surge arrester is defined as one that is suitably rated, and certified by UL (Underwriter's Laboratories), another NRTL (Nationally Recognized Testing Laboratory), or a recognized safety certification body in the country/region of use. This is to avoid damage to the equipment caused by local lightning strikes and other electrical surges.

This equipment uses CA11A telephone jacks.

## **Avis réservé aux utilisateurs du réseau téléphonique du Canada**

Ce produit est conforme aux spécifications techniques d'Industrie Canada. Le numéro REN (ringer equivalence number : numéro d'équivalence de sonnerie) fournit une indication du nombre maximum de terminaux pouvant être connectés à l'interface téléphonique. En bout de ligne, le nombre d'appareils qui peuvent être connectés n'est pas directement limité, mais la somme des REN de ces appareils ne doit pas dépasser cinq. Le numéro REN du modem est indiqué sur l'étiquette produit située à l'arrière de l'équipement.

Les compagnies de téléphone constatent que les surtensions électriques, en particulier celles dues à la foudre, entraînent d'importants dégâts sur les terminaux privés connectés à des sources d'alimentation CA. Il s'agit-là d'un problème majeur d'échelle nationale. En conséquence, il vous est recommandé de brancher un parasurtenseur dans la prise de courant à laquelle l'équipement est connecté. Utilisez un parasurtenseur répondant à des caractéristiques nominales satisfaisantes et certifié par le laboratoire d'assureurs UL (Underwriter's Laboratories), un autre laboratoire agréé de type NRTL (Nationally Recognized Testing Laboratory) ou un organisme de certification agréé dans votre région ou pays. Ceci prévient tout endommagement de l'équipement causé par les orages et autres surtensions électriques.

Cet équipement utilise des prises de téléphone CA11A.

## **Notice to users of the New Zealand telephone network**

The following are special conditions for the Facsimile User Instructions. The grant of a telepermit for any item of terminal equipment indicates only that Telecom has accepted that the item complies with minimum conditions for connection

to its network. It indicates no endorsement of the product by Telecom, nor does it provide any sort of warranty. Above all, it provides no assurance that any item will work correctly in all respects with another item of telepermitted equipment of a different make or model, nor does it imply that any product is compatible with all of Telecom's network services.

This equipment shall not be set up to make automatic calls to the Telecom's 111 Emergency Service.

This equipment may not provide for the effective hand-over of a call to another device connected to the same line.

This equipment should not be used under any circumstances that may constitute a nuisance to other Telecom customers.

Some parameters required for compliance with Telecom's telepermit requirements are dependent on the equipment associated with this device. The associated equipment shall be set to operate within the following limits for compliance to Telecom's specifications:

- There shall be no more than 10 call attempts to the same number within any 30 minute period for any single manual call initiation, and
- The equipment shall go on-hook for a period of not less than 30 seconds between the end of one attempt and the beginning of the next call attempt.
- The equipment shall be set to ensure that automatic calls to different numbers are spaced such that there is not less than 5 seconds between the end of one call attempt and the beginning of another.

## **Using this product in Switzerland**

This product requires a Swiss billing tone filter (Lexmark part number 14B5109 or 80D1877) to be installed on any line which receives metering pulses in Switzerland. The Lexmark filter must be used, as metering pulses are present on all analog telephone lines in Switzerland.

## **Utilisation de ce produit en Suisse**

Cet appareil nécessite l'utilisation d'un filtre de tonalité de facturation suisse (n° de référence Lexmark : 14B5109 ou 80D1877) devant être installé sur toute ligne recevant des impulsions de comptage en Suisse. Ce filtre doit être utilisé pour toute installation car ces impulsions existent sur toutes les lignes téléphoniques suisses.

## **Verwendung dieses Produkts in der Schweiz**

Für dieses Produkt muss ein schweizerischer Billing Tone Filter zur Zählzeichenübertragung (Lexmark Teilenummer 14B5109 oder 80D1877) für jede Leitung installiert werden, über die in der Schweiz Zeitsteuertakte übertragen werden. Die Verwendung des Lexmark Filters ist obligatorisch, da in allen analogen Telefonleitungen in der Schweiz Zeitsteuertakte vorhanden sind.

## **Uso del prodotto in Svizzera**

Questo prodotto richiede un filtro toni Billing svizzero, (codice Lexmark 14B5109 o 80D1877) da installare su tutte le linee che ricevono impulsi remoti in Svizzera. È necessario utilizzare il filtro Lexmark poiché gli impulsi remoti sono presenti su tutte le linee analogiche in Svizzera.



## Notice to Users in the European Union

Products bearing the CE mark are in conformity with the protection requirements of EC Council directives 2004/108/EC, 2006/95/EC, and 1999/5/EC on the approximation and harmonization of the laws of the Member States relating to electromagnetic compatibility, safety of electrical equipment designed for use within certain voltage limits and on radio equipment and telecommunications terminal equipment.

Compliance is indicated by the CE marking.



The manufacturer of this product is: Lexmark International, Inc., 740 West New Circle Road, Lexington, KY, 40550 USA. The authorized representative is: Lexmark International Technology Hungária Kft., 8 Lechner Ödön fasor, Millennium Tower III, 1095 Budapest HUNGARY, A declaration of conformity to the requirements of the Directives is available upon request from the Authorized Representative.

Refer to the table at the end of the Notices section for further compliance information.

## Regulatory notices for wireless products

This section contains the following regulatory information pertaining to wireless products that contain transmitters, for example, but not limited to, wireless network cards or proximity card readers.

### Exposure to radio frequency radiation

The radiated output power of this device is far below the radio frequency exposure limits of the FCC and other regulatory agencies. A minimum separation of 20 cm (8 inches) must be maintained between the antenna and any persons for this device to satisfy the RF exposure requirements of the FCC and other regulatory agencies.

### Notice to users in Brazil

Este equipamento opera em caráter secundário, isto é, não tem direito a proteção contra interferência prejudicial, mesmo de estações do mesmo tipo, e não pode causar interferência a sistemas operando em caráter primário. (Res. ANATEL 282/2001).

### Industry Canada (Canada)

This device complies with Industry Canada specification RSS-210. Operation is subject to the following two conditions: (1) this device may not cause interference, and (2) this device must accept any interference, including interference that may cause undesired operation of the device.

This device has been designed to operate only with the antenna provided. Use of any other antenna is strictly prohibited per regulations of Industry Canada.

To prevent radio interference to the licensed service, this device is intended to be operated indoors and away from windows to provide maximum shielding. Equipment (or its transmit antenna) that is installed outdoors is subject to licensing.

The installer of this radio equipment must ensure that the antenna is located or pointed such that it does not emit RF fields in excess of Health Canada limits for the general population; consult Safety Code 6, obtainable from Health Canada's Web site [www.hc-sc.gc.ca/rpb](http://www.hc-sc.gc.ca/rpb).

The term "IC:" before the certification/registration number only signifies that the Industry Canada technical specifications were met.

## **Industry Canada (Canada)**

Cet appareil est conforme à la norme RSS-210 d'Industry Canada. Son fonctionnement est soumis aux deux conditions suivantes :

(1) cet appareil ne doit pas provoquer d'interférences et (2) il doit accepter toute interférence reçue, y compris celles risquant d'altérer son fonctionnement.

Cet appareil a été conçu pour fonctionner uniquement avec l'antenne fournie. L'utilisation de toute autre antenne est strictement interdite par la réglementation d'Industry Canada.

En application des réglementations d'Industry Canada, l'utilisation d'une antenne de gain supérieur est strictement interdite.

Pour empêcher toute interférence radio au service faisant l'objet d'une licence, cet appareil doit être utilisé à l'intérieur et loin des fenêtres afin de garantir une protection optimale.

Si le matériel (ou son antenne d'émission) est installé à l'extérieur, il doit faire l'objet d'une licence.

L'installateur de cet équipement radio doit veiller à ce que l'antenne soit implantée et dirigée de manière à n'émettre aucun champ HF dépassant les limites fixées pour l'ensemble de la population par Santé Canada. Reportez-vous au Code de sécurité 6 que vous pouvez consulter sur le site Web de Santé Canada [www.hc-sc.gc.ca/rpb](http://www.hc-sc.gc.ca/rpb).

Le terme « IC » précédant le numéro de d'accréditation/inscription signifie simplement que le produit est conforme aux spécifications techniques d'Industry Canada.

## **Taiwan NCC RF notice statement**

### **NCC型式認證設備注意事項 台灣低功率射頻電機設備之使用注意事項**

經型式認證合格之低功率射頻電機，非經許可，公司、商號或使用者均不得擅自變更頻率、加大功率或變更原設計之特性及功能。

低功率射頻電機之使用不得影響飛航安全及干擾合法通信；經發現有干擾現象時，應立即停用，並改善至無干擾時方得繼續使用。前項合法通信，指依電信規定作業之無線電信。低功率射頻電機須忍受合法通信或工業、科學及醫療用電波輻射性電機設備之干擾。

## **Notice to users in the European Union**

Products bearing the CE mark are in conformity with the protection requirements of EC Council directives 2004/108/EC, 2006/95/EC, and 1999/5/EC on the approximation and harmonization of the laws of the Member States relating to electromagnetic compatibility, safety of electrical equipment designed for use within certain voltage limits and on radio equipment and telecommunications terminal equipment.

Compliance is indicated by the CE marking.



The manufacturer of this product is: Lexmark International, Inc., 740 West New Circle Road, Lexington, KY, 40550 USA. The authorized representative is: Lexmark International Technology Hungária Kft., 8 Lechner Ödön fasor, Millennium Tower III, 1095 Budapest HUNGARY, A declaration of conformity to the requirements of the Directives is available upon request from the Authorized Representative.

This product satisfies the Class B limits of EN 55022 and safety requirements of EN 60950.

Products equipped with 2.4GHz Wireless LAN option are in conformity with the protection requirements of EC Council directives 2004/108/EC, 2006/95/EC, and 1999/5/EC on the approximation and harmonization of the laws of the Member States relating to electromagnetic compatibility, safety of electrical equipment designed for use within certain voltage limits and on radio equipment and telecommunications terminal equipment.

Compliance is indicated by the CE marking.



Operation is allowed in all EU and EFTA countries, but is restricted to indoor use only.

The manufacturer of this product is: Lexmark International, Inc., 740 West New Circle Road, Lexington, KY, 40550 USA. The authorized representative is: Lexmark International Technology Hungária Kft., 8 Lechner Ödön fasor, Millennium Tower III, 1095 Budapest HUNGARY, A declaration of conformity to the requirements of the Directives is available upon request from the Authorized Representative.

This product may be used in the countries indicated in the table below.

AT	BE	BG	CH	CY	CZ	DE	DK	EE
EL	ES	FI	FR	HR	HU	IE	IS	IT
LI	LT	LU	LV	MT	NL	NO	PL	PT
RO	SE	SI	SK	TR	UK			

Česky	Společnost Lexmark International, Inc. tímto prohlašuje, že výrobek tento výrobek je ve shodě se základními požadavky a dalšími příslušnými ustanoveními směrnice 1999/5/ES.
Dansk	Lexmark International, Inc. erklærer herved, at dette produkt overholder de væsentlige krav og øvrige relevante krav i direktiv 1999/5/EF.
Deutsch	Hiermit erklärt Lexmark International, Inc., dass sich das Gerät dieses Gerät in Übereinstimmung mit den grundlegenden Anforderungen und den übrigen einschlägigen Bestimmungen der Richtlinie 1999/5/EG befindet.
Ελληνική	ΜΕ ΤΗΝ ΠΑΡΟΥΣΑ Η LEXMARK INTERNATIONAL, INC. ΔΗΛΩΝΕΙ ΟΤΙ ΑΥΤΟ ΤΟ ΠΡΟΪΟΝ ΣΥΜΜΟΡΦΩΝΕΤΑΙ ΠΡΟΣ ΤΙΣ ΟΥΣΙΩΔΕΙΣ ΑΠΑΙΤΗΣΕΙΣ ΚΑΙ ΤΙΣ ΛΟΙΠΕΣ ΣΧΕΤΙΚΕΣ ΔΙΑΤΑΞΕΙΣ ΤΗΣ ΟΔΗΓΙΑΣ 1999/5/ΕΚ.
English	Hereby, Lexmark International, Inc., declares that this type of equipment is in compliance with the essential requirements and other relevant provisions of Directive 1999/5/EC.

Español	Por medio de la presente, Lexmark International, Inc. declara que este producto cumple con los requisitos esenciales y cualesquiera otras disposiciones aplicables o exigibles de la Directiva 1999/5/CE.
Eesti	Käesolevaga kinnitab Lexmark International, Inc., et seade see toode vastab direktiivi 1999/5/EÜ põhinõuetele ja nimetatud direktiivist tulenevatele muudele asjakohastele sätetele.
Suomi	Lexmark International, Inc. vakuuttaa täten, että tämä tuote on direktiivin 1999/5/EY oleellisten vaatimusten ja muiden sitä koskevien direktiivin ehtojen mukainen.
Français	Par la présente, Lexmark International, Inc. déclare que l'appareil ce produit est conforme aux exigences fondamentales et autres dispositions pertinentes de la directive 1999/5/CE.
Magyar	Alulírott, Lexmark International, Inc. nyilatkozom, hogy a termék megfelel a vonatkozó alapvető követelményeknek és az 1999/5/EC irányelv egyéb előírásainak.
Íslenska	Hér með lýsir Lexmark International, Inc. yfir því að þessi vara er í samræmi við grunnkröfur og aðrar kröfur, sem gerðar eru í tilskipun 1999/5/EC.
Italiano	Con la presente Lexmark International, Inc. dichiara che questo prodotto è conforme ai requisiti essenziali ed alle altre disposizioni pertinenti stabilite dalla direttiva 1999/5/CE.
Latviski	Ar šo Lexmark International, Inc. deklarē, ka šis izstrādājums atbilst Direktīvas 1999/5/EK būtiskajām prasībām un citiem ar to saistītajiem noteikumiem.
Lietuvių	Šiuo Lexmark International, Inc. deklaruoja, kad šis produktas atitinka esminius reikalavimus ir kitas 1999/5/EB direktyvos nuostatas.
Malti	Bil-preżenti, Lexmark International, Inc., jiddikjara li dan il-prodott huwa konformi mal-ftigijiet essenzjali u ma dispozizzjonijiet oħrajn relevanti li jinsabu fid-Direttiva 1999/5/KE.
Nederlands	Hierbij verklaart Lexmark International, Inc. dat het toestel dit product in overeenstemming is met de essentiële eisen en de andere relevante bepalingen van richtlijn 1999/5/EG.
Norsk	Lexmark International, Inc. erklærer herved at dette produktet er i samsvar med de grunnleggende krav og øvrige relevante krav i direktiv 1999/5/EF.
Polski	Niniejszym Lexmark International, Inc. oświadcza, że niniejszy produkt jest zgodny z zasadniczymi wymogami oraz pozostałymi stosownymi postanowieniami Dyrektywy 1999/5/EC.
Português	A Lexmark International Inc. declara que este produto está conforme com os requisitos essenciais e outras disposições da Diretiva 1999/5/CE.
Slovensky	Lexmark International, Inc. týmto vyhlasuje, že tento produkt spĺňa základné požiadavky a všetky príslušné ustanovenia smernice 1999/5/ES.
Slovensko	Lexmark International, Inc. izjavlja, da je ta izdelek v skladu z bistvenimi zahtevami in ostalimi relevantnimi določili direktive 1999/5/ES.
Svenska	Härmed intygar Lexmark International, Inc. att denna produkt står i överensstämmelse med de väsentliga egenskapskrav och övriga relevanta bestämmelser som framgår av direktiv 1999/5/EG.

# Index

## A

- ad hoc
  - SSID 94
  - WEP 94
- ad hoc network 104
- ad hoc wireless network
  - adding a printer 97
  - creating using Macintosh 94
  - creating using Windows 94
- additional computers
  - installing wireless printer 91
- Address Book
  - setting up 78
- Address Book, fax
  - setting 76
- adjusting dialing and ringer volume 85
- adjusting speaker volume 85
- AliceBox 92
- aligning the printhead 113
- answering machine
  - best settings for fax 85
  - setting up 65
- appliances
  - wireless network 106
- application list
  - downloading 64
  - updating 64
- assigning IP address 110
- Auto Answer
  - when to turn on 83
- Automatic Document Feeder (ADF) 10
  - clearing a paper jam in 124
  - loading documents 32
  - output tray 9
  - paper capacity 32
  - paper guide 9
  - tray 10
- automatic fax conversion
  - setting 76

## B

- banner paper 29
- bidirectional communication
  - enabling 152
- black and white scanning 63
- blocking faxes 88

- Bluetooth
  - printing 48
  - setting the security level 47
  - setting up a connection 46
- broadcast fax, sending
  - immediately 80
- buttons, printer control panel
  - 2-sided/Eco-Mode 16
  - Address Book 17
  - Back 17
  - Cancel 18
  - Color/Black 17
  - Copy 16
  - Dialtone 17
  - Display 16
  - Fax 16
  - Keypad 18
  - Photo 16
  - Power 16
  - Scan 16
  - Select 17
  - Settings 17
  - Start 17

## C

- cable
  - installation 103, 104
  - USB 104
- Caller ID 75
- Caller ID pattern, fax
  - setting 76
- camera
  - connecting 44
- canceling
  - copy job 57
  - print job 51
  - scan job 64
- cannot delete documents from print queue 122
- cannot print from a flash drive 138
- cannot print over wireless network 141
- cannot print through USB 122
- cannot receive faxes 134
- cannot run fax software 135
- cannot scan to computer over a network 130
- cannot send faxes 132
- cartridges, ink
  - ordering 12
  - using genuine Lexmark 12
- changing Power Saver timeout 19
- changing printing mode 49
- changing temporary settings into default 18
- changing wireless settings after installation (Mac) 93
- changing wireless settings after installation (Windows) 93
- checking an unresponsive printer 116
- checking ink levels 112
- checking the dial tone 84
- checklist
  - before you troubleshoot 116
  - fax troubleshooting 131
  - memory card troubleshooting 138
- choosing a splitter, faxing 82
- cleaning exterior of the printer 114
- cleaning printhead nozzles 114
- Club Internet 92
- collating copies 55
- Communication not available message 152
- computer slows down when printing 128
- configuring
  - fax settings 76, 77
  - IP address 93
- confirmation page, fax 87
- connection
  - configurations 108
- conserving energy
  - using Eco-Mode 20
- conserving energy, ink, and paper 6
- conserving paper
  - using Eco-Mode 20
- contact list
  - setting up 78
- continue button greyed out 144
- continue button not working 144
- continue button unavailable 144
- copier or scanner does not respond 128
- copies
  - making 53

- copy and scan troubleshooting
  - cannot scan to computer over a network 130
  - copier or scanner does not respond 128
  - partial document or photo scans 129
  - poor scanned image quality 128
  - scan not successful 129
  - scanning takes too long or freezes the computer 130
- copy job
  - canceling 57
- copy quality, adjusting 54
- copy troubleshooting
  - scanner unit does not close 128
- copying 53
  - adjusting quality 54
  - collating copies 55
  - enlarging an image 54
  - making a copy lighter or darker 54
  - multiple page images on one sheet 56
  - on both sides of the paper 56
  - Pages per Sheet 56
  - photos 53
  - reducing an image 54
  - repeating an image 55
  - tips 53
- custom-size paper
  - printing on 40

## D

- default printer, setting 49
- defaults
  - resetting factory defaults 20
- dial method, fax
  - setting 76
- dial tone
  - checking 84
- dial tone volume
  - adjusting 85
- dialing prefix 83
- Digital Subscriber Line (DSL)
  - fax setup 68
- digital telephone service
  - fax setup 70
- disabling settings timeout 18
- distinctive ring 84
- documents
  - faxing using the computer 80
  - faxing using the control panel 80

- loading into the Automatic Document Feeder (ADF) 32
- loading on scanner glass 32
- printing 33
- scanning for editing 61
- scanning using the printer control panel 58
- DSL filter 68
- duplex
  - copying, automatic 56
  - copying, manual 56
  - printing, manual 36
- duplex unit 10

## E

- Eco-Mode
  - using 20
- emission
  - notices 158, 159, 165, 169, 170
- energy
  - conserving 6
- enlarging an image 54
- entering
  - fax user information 75
- envelopes 30
  - loading 38
  - printing 38
- error correction, fax
  - setting 76
- error using memory card 138
- Ethernet 108
- exterior of the printer
  - cleaning 114
- e-mailing
  - scanned documents 62

## F

- factory default settings
  - resetting internal wireless print server 140
  - resetting to 20
- failed faxes
  - retrieving 88
- fax
  - confirmation page 87
  - printer memory 88
  - transmission report 87
- fax activity report 87
- fax blocking
  - setting 76

- fax error messages
  - Digital Line Detected 136
  - Failed To Connect 136
  - Fax Mode Unsupported 136
  - Fax Modem Error 136
  - No Answer 137
  - No Caller ID 137
  - Phone Line Busy 137
  - Phone Line Error 136
  - Phone Line is connected to the incorrect jack on the back of the machine 136
  - Phone Line Not Connected 136
  - Remote Fax Error 135
  - Unrecoverable Fax Error 136
  - Unsupported Compression 136
  - Unsupported Resolution 136
- fax footer
  - setting 76
- fax forwarding 87
- fax header
  - setting 76
- fax header and footer
  - setting 75
- fax number 83
- fax printing
  - setting 76
- fax quality
  - setting 85
- fax resolution
  - setting 85
- fax sending speed
  - setting 76
- fax settings
  - configuring 76, 77
  - for answering machine 85
  - for voice mail 85
- fax setup
  - country-specific 71
  - digital telephone service 70
  - DSL connection 68
  - standard telephone line connection 65
  - VoIP 69
- Fax Setup Utility 77
- Fax Setup Wizard 77
- fax troubleshooting
  - cannot receive faxes 134
  - cannot run fax software 135
  - cannot send faxes 132
  - error messages, printer control panel 135

- fax troubleshooting checklist 131
- faxing
  - Address Book 78
  - blocking 88
  - calling card, using 86
  - dial prefix 83
  - distinctive ring 84
  - pick up on 83
  - receiving automatically 81
  - receiving manually 81
  - rings 83
  - scheduling 86
  - sending a broadcast fax
    - immediately 80
  - sending using the control panel 80
  - setup 82
  - tips, receiving 81
  - tips, sending 80
  - using the computer 80
  - using the control panel 80
- faxing tips
  - receiving faxes automatically 81
  - receiving faxes manually 81
- FCC notices 158, 166, 169
- file types
  - supported 42
- finding
  - information 7
  - MAC address 109
  - publications 7
  - Web site 7
- finding IP address of computer (Mac) 110
- firewall on computer 145
- flash drive
  - inserting 41
  - printing documents from 37
  - printing photos using the proof sheet 45
  - scanning to 59
- forwarding faxes 87
- France
  - special wireless setup instructions 92
- FreeBox 92

## G

- greeting cards 30
- Group Dial
  - setting up 78

## H

- heavyweight matte paper 29

## I

- improving scan quality 63
- incorrect language appears on display 117
- index cards 30
- information
  - finding 7
- information needed for setting up printer on wireless network 90
- infrastructure network 104
- ink
  - conserving 6
- ink cartridge access 11
- ink cartridges
  - ordering 12
  - replacing 13
  - using genuine Lexmark 12
- ink levels
  - checking 112
- inserting a memory card or flash drive 41
- installation
  - cable 103, 104
- installing
  - network printer 110
- installing optional software 25
- installing printer
  - on wireless network (Macintosh) 91
  - on wireless network (Windows) 91
- installing printer software 27
- installing wireless printer
  - additional computers 91
- interference
  - wireless network 106
- internal wireless print server
  - resetting to factory default settings 140
- IP address 109, 110
  - configuring 93
- IP address, assigning 110
- iron-on transfers 31

## J

- jams and misfeeds troubleshooting
  - paper jam in the ADF 124
  - paper jam in the duplex unit 123

- paper jam in the paper support 123
- paper jam in the printer 123
- paper or specialty media 125
- junk faxes
  - blocking 88

## K

- key index 111

## L

- labels 30
  - printing 39
- language
  - changing 117
- line filter 68
- LiveBox 92
- loading
  - documents into the Automatic Document Feeder (ADF) 32
  - documents on scanner glass 32
  - envelopes 38
- loading paper 28
- locating
  - SSID 101
  - WEP key 101
  - WPA passphrase 101

## M

- MAC address 108
  - finding 109
- MAC address filtering 108
- Macintosh
  - installing printer on wireless network 91
  - USB 98
  - wireless 98
- Macintosh printer software
  - using 23
- memory card
  - inserting 41
  - printing documents from 37
  - printing photos using the proof sheet 45
  - scanning to 59
  - supported types 42
- memory card cannot be inserted 138
- memory card slots 9

- memory card troubleshooting
  - cannot print from a flash drive 138
  - checklist 138
  - nothing happens when memory card is inserted 138
- minimum system requirements 21
- multiple WEP keys 111

## N

- N9UF Box 92
- network connection
  - with USB 108
- network overview 101
- network printer
  - installing 110
- network security 102
- network setup page
  - printing 90
- networking
  - finding IP address of computer 110
  - finding IP address of computer (Mac) 110
  - finding IP address of printer 110
  - IP addresses 110
  - sharing the printer with a Macintosh computer 100
  - sharing the printer with a Windows computer 100
- no wireless network 94
- noise emission levels 159
- nothing happens when memory card is inserted 138
- notices 158, 159, 160, 161, 165, 166, 167, 168, 169, 170, 171

## O

- on-hook faxing 86
- ordering paper and other supplies 14

## P

- page does not print 120
- Pages per Sheet copies 56
- paper
  - conserving 6
- paper and media
  - banner paper 29
  - envelopes 30
  - heavyweight matte paper 29

- index cards 30
- iron-on transfers 31
- photo cards 30
- photo/glossy paper 30
- plain paper 29
- postcards 30
- transparencies 31
- paper and other supplies
  - ordering 14
- paper default settings
  - saving 31
- paper exit tray 9
- paper feed guard 10
- paper guides 10
- paper jam in the ADF 124
- paper jam in the duplex unit 123
- paper jam in the paper support 123
- paper jam in the printer 123
- paper or specialty media
  - misfeeds 125
- paper support 9
- partial document or photo scans 129
- parts
  - diagram 9
- password 102
- pausing
  - print job 50
- PDF
  - creating from scan 62
- phone book
  - setting up 78
- phone plug 71
- phone splitter 69
- photo cards 30
- photo/glossy paper 30
- photos
  - copying photos 53
  - making borderless copies 54
  - printing from digital camera using DPOF 46
  - printing using printer control panel 42
  - printing using the proof sheet 45
  - scanning for editing 59
- photos do not print from memory card across wireless network 139
- photos from memory device
  - printing using printer software 43
- PictBridge port 9
- PictBridge-enabled camera
  - connecting 44

- plain paper 29
- poor quality at the edges of page 126
- poor scanned image quality 128
- postcards 30
- Power Saver timeout
  - changing 19
- power supply port 10
- print job
  - canceling 51
  - pausing 50
  - resuming 51
- print media
  - greeting cards 30
  - labels 30
- print speed is slow 127
- print troubleshooting
  - cannot delete documents from print queue 122
  - computer slows down when printing 128
  - poor quality at the edges of page 126
  - slow print speed 127
  - streaks or lines on printed image 127
- printer
  - sharing 99
  - sharing in Windows 99
- printer control panel 9
  - using 16
- printer does not print
  - wireless 145
- printer does not print wirelessly 146
- printer does not respond 121
- printer memory
  - fax 88
- printer printing blank pages 121
- printer problems, basic solutions 116
- Printer Settings 77
- printer software
  - installing 27
  - uninstalling 26
- printer, setting as default 49
- printhead
  - aligning 113
- printhead access 11
- printhead error 117
- printhead nozzles
  - cleaning 114



- printing
  - collate 34
  - custom-size paper 40
  - documents 33
  - documents from memory card or flash drive 37
  - envelopes 38
  - from a Bluetooth-enabled device 48
  - from a PictBridge-enabled camera 44
  - labels 39
  - last page first 34
  - multiple pages on one sheet 35
  - network setup page 90
  - on both sides of the paper 36
  - photos from digital camera using DPOF 46
  - photos from memory device using printer software 43
  - photos using printer control panel 42
  - photos using the proof sheet 45
  - reverse page order 34
  - tips 33
  - two-sided 36
- printing a confirmation page 87
- printing a transmission report 87
- printing in draft mode 49
- printing mode
  - changing 49
- proof sheet
  - using 45
- protocol 110
- publications
  - finding 7

## R

- received history report 87
- receiving faxes
  - Auto Answer setting 81
  - automatically 81
  - manually 81
  - tips 81
- recycling 6
  - Lexmark products 15
  - WEEE statement 160
- redial attempts, fax
  - setting 76
- redial time, fax
  - setting 76
- reducing an image 54

- registering
  - fax user information 75
  - Transmit Terminal Identification (TTI) 75
- repeating an image 55
- replacing ink cartridges 13
- reports
  - fax history 87
- reports, fax
  - setting 76
- resetting
  - internal wireless print server to factory default settings 140
- resetting to factory defaults 20
- resuming
  - print job 51
- reverse page order 34
- ringer volume
  - adjusting 85
- RJ-11 adapter 71

## S

- safety information 5
- saving paper default settings 31
- scan
  - black and white 63
  - improving quality 63
  - PIN 63
- scan job
  - canceling 64
- scan was not successful 129
- scanner glass 10
  - cleaning 115
- scanner lid 10
- scanner unit 11
- scanner unit does not close 128
- scanning
  - creating a PDF from scan 62
  - documents for editing 61
  - documents for e-mailing 62
  - photos for editing 59
  - tips 58
  - to a computer 58
  - to a flash drive 59
  - to a memory card 59
  - to a network 58
  - using the printer control panel 58
- scanning takes too long or freezes the computer 130
- scheduled fax
  - sending 86

- security
  - wireless network 89
- security information
  - wireless network 102
- security key 102
- selecting the wireless port 152
- sender information
  - registering 75
- sending a scheduled fax 86
- sending faxes, tips 80
- sent history report 87
- Service Center 116
- setting
  - Auto Answer 83
  - Caller ID 75
  - fax header and footer 75
  - fax quality 85
  - maximum sending speed 76
  - sender information 75
  - Transmit Terminal Identification (TTI) 75
- setting up fax
  - country-specific 71
  - digital telephone service 70
  - DSL connection 68
  - standard telephone line connection 65
  - VoIP connection 69
- setting up printer
  - faxing 82
  - on wireless network (Macintosh) 91
  - on wireless network (Windows) 91
- settings timeout
  - disabling 18
- setup troubleshooting
  - cannot print through USB 122
  - incorrect language appears on display 117
  - page does not print 120
  - printer does not respond 121
  - printer printing blank pages 121
  - printhead error 117
  - software did not install 119
- shared printing 100
- sharing printer in Windows 99
- software
  - Service Center 116
  - software did not install 119
  - software updates
    - checking 25

- enabling 25
- software, optional
  - finding, installing 25
- speaker volume
  - adjusting 85
- Speed Dial
  - setting up 78
- splitter, choosing 82
- SSID
  - ad hoc 94
  - finding 107
  - locating 101
  - wireless network 101
- streaks or lines on printed image 127
- supported memory cards and file types 42
- supported operating systems 21
- switching from USB
  - to wireless 97
  - to wireless, using Mac OS X 98
- switching from wireless
  - to USB 97
  - to USB, using Mac OS X 98

## T

- TCP/IP 110
- technical support 116
- telecommunication
  - notices 166, 167, 168, 169
- temporary settings
  - changing into default 18
- tips for
  - copying 53
  - printing 33
  - receiving faxes 81
  - scanning 58
  - sending faxes 80
- transmission report, fax 87
- transparencies 31
- troubleshooting
  - checking an unresponsive printer 116
  - contacting technical support 116
  - fax checklist 131
  - Service Center 116
  - solving basic printer problems 116
  - wireless network 140
- troubleshooting, copy
  - scanner unit does not close 128

- troubleshooting, copy and scan
  - cannot scan to computer over a network 130
  - copier or scanner does not respond 128
  - partial document or photo scans 129
  - poor scanned image quality 128
  - scan not successful 129
  - scanning takes too long or freezes the computer 130
- troubleshooting, fax
  - cannot receive faxes 134
  - cannot run fax software 135
  - cannot send faxes 132
  - error messages, printer control panel 135
- troubleshooting, jams and misfeeds
  - paper jam in the ADF 124
  - paper jam in the duplex unit 123
  - paper jam in the paper support 123
  - paper jam in the printer 123
  - paper or specialty media 125
- troubleshooting, memory card
  - cannot print from a flash drive 138
  - checklist 138
  - nothing happens when memory card is inserted 138
- troubleshooting, print
  - cannot delete documents from print queue 122
  - computer slows down when printing 128
  - poor quality at the edges of page 126
  - slow print speed 127
  - streaks or lines on printed image 127
- troubleshooting, setup
  - cannot print through USB 122
  - incorrect language appears on display 117
  - page does not print 120
  - printer does not respond 121
  - printer printing blank pages 121
  - printhead error 117
  - software did not install 119
- troubleshooting, wireless
  - cannot print over wireless network 141

- changing wireless settings after installation (Mac) 93
- changing wireless settings after installation (Windows) 93
- photos do not print from memory card across wireless network 139
- resolving communication problems 154
- Wi-Fi indicator light is blinking orange 148
- Wi-Fi indicator light is not lit 145
- Wi-Fi indicator light is still orange 147
- TX report, fax 87

## U

- UK
  - special wireless setup instructions 92
- uninstalling printer software 26
- updating printer software 25
- updating the application list 64
- USB 97, 108
  - cable 104
  - Macintosh 98
- USB connection
  - with network connection 108
- USB port 11
- user information, fax
  - setting 76
- using
  - Macintosh printer software 23
  - Web Links 23

## V

- Virtual Private Network 154
- voice mail
  - setting up 65
- voice mail, fax settings 85
- Voice over Internet Protocol (VoIP)
  - fax setup 69
- VoIP adapter 69
- volume, adjusting
  - ringer and dial tone 85
  - speaker 85
- VPN
  - lose connection to printer 154

## W

Web Links

using 23

Web site

finding 7

WEP 89

ad hoc 94

WEP key

key index 111

locating 101

Windows

installing printer on wireless  
network 91

Windows software

Abbyy Sprint OCR 21

Fast Pics 21

Fax Setup Utility 21

Fax Solutions software 21

Printer Home 21

Printing Preferences 21

Service Center 21

Toolbar 21

Tools for Office 21

Wireless Setup Utility 21

wireless 97, 108

Macintosh 98

printer does not print 145

troubleshooting 146, 154

wireless network

adding a printer to existing ad hoc  
network 97

common home

configurations 102

creating an ad hoc network using  
Macintosh 94

creating an ad hoc network using  
Windows 94

information needed for setting up  
wireless printing 90

installing printer on  
(Macintosh) 91

installing printer on (Windows) 91

interference 106

resolving communication  
problems 154

security 89

security information 102

signal strength 105

SSID 101

troubleshooting 140

types of wireless networks 104

wireless network compatibility 89

wireless print server

not installed 152

wireless settings

changing after installation  
(Mac) 93

changing after installation  
(Windows) 93

wireless setup

information needed for 90

wireless signal

strength 105

wireless signal absorption 106

wireless troubleshooting

cannot print over wireless  
network 141

changing wireless settings after  
installation (Mac) 93

changing wireless settings after  
installation (Windows) 93

photos do not print from memory  
card across wireless

network 139

printer and computer on different  
networks 107

printer works intermittently on  
wireless network 154

Wi-Fi indicator light is blinking  
orange 148

Wi-Fi indicator light is not lit 145

Wi-Fi indicator light is still  
orange 147

Wi-Fi indicator 9

description of colors 92  
light is not lit 145

Wi-Fi indicator light is blinking  
orange 148

Wi-Fi indicator light is green  
printer does not print 146

Wi-Fi indicator light is still  
orange 147

Wi-Fi Protected Setup 97  
using 100

Wi-Fi Protected Setup logo  
identifying 100

WPA 89

WPA passphrase  
locating 101

WPA2 89

WPS 97