

Lexmark Z42

Color Jetprinter™

User's Guide for Windows 95 and Windows 98

Edition: January 2000

The following paragraph does not apply to any country where such provisions are inconsistent with local law: LEXMARK INTERNATIONAL, INC., PROVIDES THIS PUBLICATION "AS IS" WITHOUT WARRANTY OF ANY KIND, EITHER EXPRESS OR IMPLIED, INCLUDING, BUT NOT LIMITED TO, THE IMPLIED WARRANTIES OF MERCHANTABILITY OR FITNESS FOR A PARTICULAR PURPOSE. Some states do not allow disclaimer of express or implied warranties in certain transactions; therefore, this statement may not apply to you.

This publication could include technical inaccuracies or typographical errors. Changes are periodically made to the information herein; these changes will be incorporated in later editions. Improvements or changes in the products or the programs described may be made at any time.

References in this publication to products, programs, or services do not imply that the manufacturer intends to make these available in all countries in which it operates. Any reference to a product, program, or service is not intended to state or imply that only that product, program, or service may be used. Any functionally equivalent product, program, or service that does not infringe any existing intellectual property right may be used instead. Evaluation and verification of operation in conjunction with other products, programs, or services, except those expressly designated by the manufacturer, are the user's responsibility.

Lexmark, Lexmark with diamond design, and ColorFine are trademarks of Lexmark International, Inc., registered in the United States and/or other countries. Color Jetprinter is a trademark of Lexmark International, Inc.

Other trademarks are the property of their respective owners.

© Copyright 2000 Lexmark International, Inc. All rights reserved.

UNITED STATES GOVERNMENT RESTRICTED RIGHTS

This software and documentation are provided with RESTRICTED RIGHTS. Use, duplication or disclosure by the Government is subject to restrictions as set forth in subparagraph (c)(1)(ii) of the Rights in Technical Data and Computer Software clause at DFARS 252.227-7013 and in applicable FAR provisions: Lexmark International, Inc., Lexington, KY 40550.



Contents



Steps to basic printing 1

Step 1: Load the paper 2

Step 2: Customize the printer settings 5

Step 3: Print your document 8

Printing beyond the basics 9

Printing on both sides of a sheet of paper 9

Printing handouts 12

Printing booklets 15

Printing posters 18

Maintaining your printer 21

Using the Control Program 21

Installing or replacing print cartridges 22

Improving print quality 24

Preserving print cartridges 26

Troubleshooting 27

Printer prints slowly or doesn't print 28

Paper misfeeds or jams 31

Document prints with mistakes or poor quality 32

Problems with transparencies, photos, or envelopes 35

Error messages and flashing lights 36

Appendix 37

Installing printer software 37

Uninstalling printer software 38

Printing from DOS 38

Statement of Limited Warranty 38

Electronic emission notices 40

Energy star 41

Power supply 41

Safety information 41

Index 43

1**Steps to basic printing**

This book describes how to use your printer with Windows 95 and Windows 98.

If you are using your printer with Windows NT 4.0 or Windows 2000, refer to the User's Guide button on the printer software CD for Windows.

Basic printing is as easy as:

- 1** Load the paper (see page 2).
- 2** Customize the printer settings (see page 5).
- 3** Print your document (see page 8).

Step 1: Load the paper

You can load up to 100 sheets of paper (depending on thickness).

- 1 Place the paper against the right side of the sheet feeder, with the print side facing you.

Note: Make sure you do not force the paper into the sheet feeder when you load it. For example, letter or A4 size paper should extend above the top of the paper support.

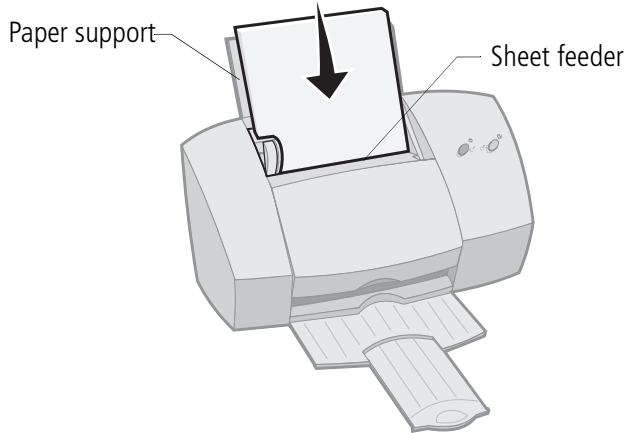

- 2 Squeeze the release tab and the paper guide together and slide the paper guide to the edge of the paper.

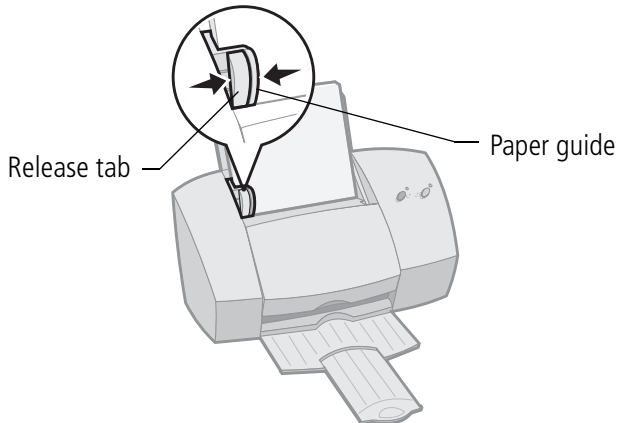

Loading specialty papers

Follow these guidelines when loading specialty papers:

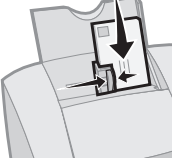
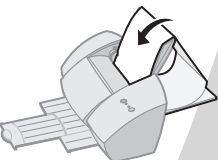
Load up to:	Make sure:
10 envelopes	<ul style="list-style-type: none"> the print side is facing you. the envelopes are loaded vertically against the right side of the sheet feeder. the stamp location is in the upper left corner. the paper guide is against the edge of the envelopes. 
10 greeting cards, index cards, postcards, or photo cards	<ul style="list-style-type: none"> the print side is facing you. the cards are loaded vertically against the right side of the sheet feeder. the paper guide is against the edge of the cards.
25 sheets of photo paper	<ul style="list-style-type: none"> the glossy or coated side is facing you. the paper guide is against the edge of the photo paper.
20 sheets of banner paper	<ul style="list-style-type: none"> you place the paper behind the printer, and then bring the unattached edge of the first page over the top of the printer, and into the sheet feeder. the paper guide is against the edge of the paper.  <p>Note: Make sure you select Banner or Banner A4 paper size in the Printer Properties.</p>

Load up to:	Make sure:
10 transparencies	<ul style="list-style-type: none"> • the rough sides of the transparencies are facing you (smooth side down). • the paper guide is against the edge of the transparencies.
100 sheets of custom size paper	<ul style="list-style-type: none"> • the print side is facing you. • your paper size fits within these dimensions: <ul style="list-style-type: none"> - Width: <ul style="list-style-type: none"> 76 mm to 216 mm 3.0 in. to 8.5 in. - Length: <ul style="list-style-type: none"> 127 mm to 432 mm 5.0 in. to 17.0 in. • the paper guide is against the side of the paper.
25 iron-on transfers	<ul style="list-style-type: none"> • you follow the instructions on the packaging to load the iron-on transfers. • the paper guide is against the side of the iron-on transfers.

Step 2: Customize the printer settings

Your printer software includes several applications that let you perform printing tasks. One of these applications is called **Printer Properties**.

The Printer Properties has four tabs: **Job Finishing**, **Paper, Document/Quality**, and **Advanced**. Each tab has settings for operating your printer and its software.

Opening the Printer Properties from an application

You can open the Printer Properties from almost every application. This lets you change printer settings **ONLY** for the documents you are currently creating in the application.

- 1 Open the application's **File** menu.
- 2 Choose **Print** (or **Printer**) **Setup**.
- 3 In the Printer Setup dialog box, click the **Properties**, **Option**, or **Setup** button (depending on the application).

Opening the Printer Properties from Windows

When you open the Printer Properties from Windows, the settings apply to **ALL** documents, unless you change them from the application.

- 1 From the **Start** menu, select **Settings**, and then select **Printers**.
- 2 From the Printers folder, right-click the printer icon for your printer.
- 3 Select **Properties** from the sidebar menu.

Click the...

Paper tab to:

- Select a paper size and orientation
- Set the number of copies to print
- Reverse the printing order of your document pages. The first page of your document will be on top of the stack in the paper exit tray.
- Collate your document

Document/Quality tab to select:

- Color settings for the type of document you are printing
- The type of paper you are using
- A print quality setting
- Web Smoothing when you print from the internet
- Allow Pages to Dry
- The default settings

Job Finishing tab to print:

- Handouts
- Posters
- Booklets
- Two-sided documents

Advanced tab to adjust:

- Halftone settings
- Image settings

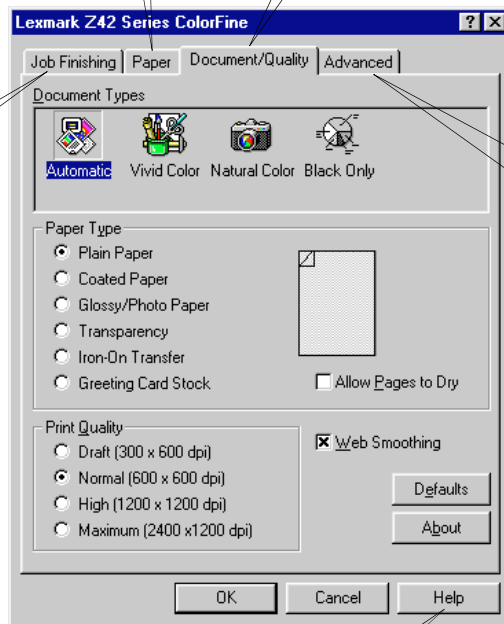

Help button on any tab in the Printer Properties to access the printer driver Help.

Customizing printer settings for specialty papers

When your printer software was installed, the Printer Properties settings were set to the default settings. Use the default settings for printing most documents on plain paper. To change your printer settings for printing on specialty papers, use the following table.

When you are printing on:	Click this Printer Properties tab:	To make these selections:
Envelopes	Paper	From the Paper Size area, scroll to select the appropriate envelope size. Note: <i>Your application may override the envelope settings in Printer Properties.</i>
Greeting cards, index cards, postcards, or photo cards	Paper Document/Quality	Select the appropriate Paper Size setting. From the Paper Type area, select Greeting Card Stock .
Photo papers	Document/Quality	From the Paper Type area, select Glossy/Photo Paper . Notes: <ul style="list-style-type: none"> • You can print quality photos with the black and color cartridge combination that came with your printer. However, for the best possible print quality, replace the black cartridge with a photo cartridge, Lexmark part number 12A1990. For help, see page 22. • When printing photos, remove each photo as it exits from the printer and allow it to dry before stacking.
Banner paper	Paper	From the list of Paper Sizes, select Banner or Banner A4 .

When you are printing on:	Click this Printer Properties tab:	To make these selections:
Sheets of custom size paper	Paper	<ul style="list-style-type: none"> From the list of Paper Sizes, scroll to select Custom. Enter the dimensions for your custom paper size. For help, see page 4.
Iron-on transfers	Document/Quality	<p>From the Paper Type area, select Iron-On Transfer.</p> <p><i>Note: Many software applications accept iron-on transfers differently. We recommend printing your document on plain paper before printing it on an iron-on transfer.</i></p>
Transparencies	Document/Quality	<ul style="list-style-type: none"> From the Paper Type area, select Transparency. Select Normal (600 x 600 dpi), High (1200 x 1200 dpi), or Maximum (2400 x 1200 dpi) Print Quality. <p><i>Note: When printing transparencies, remove each transparency as it exits from the printer and allow it to dry before stacking.</i></p>

Step 3: Print your document

- 1 From your application's **File** menu, click **Print**.
- 2 From the Print dialog box, click **OK** or **Print** (depending on the application).

2

Printing beyond the basics



You can use your printer to print:

- on both sides of a sheet of paper (see the following section)
- handouts (see page 12)
- booklets (see page 15)
- posters (see page 18)

Printing on both sides of a sheet of paper

Your Lexmark printer lets you print on both sides of a sheet of paper. Besides saving paper, this feature is helpful when you want to print booklets or tablets.

Step 1: Load the paper

Load up to 100 sheets of paper against the right side of the sheet feeder and slide the paper guide to the edge of the paper. For help, see page 2.

Step 2: Customize the printer settings for your two-sided print job

- 1 Open the Printer Properties. For help, see page 5.
- 2 Select the page orientation and size:
 - a Click the **Paper** tab.
 - b Select the appropriate **Paper Size**.
 - c Select **Portrait** or **Landscape** orientation.
- 3 Customize the Printer Properties for two-sided printing:

a Click the **Job Finishing** tab.

b Select **Two-sided printing**.

c Select a **binding edge**. When you select **Portrait** orientation, choose between these binding edge options.

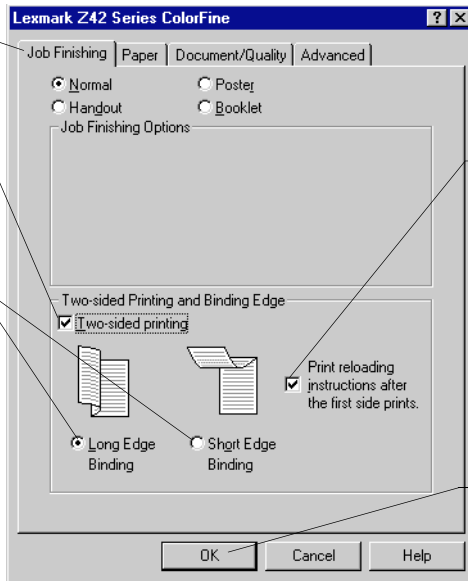

d To receive paper reloading instructions, select **Print reloading instructions after the first side prints**.

e Click **OK**.

Note: When you select **Landscape** orientation, choose between these binding edge options:



Long Edge Binding



Short Edge Binding

Step 3: Print your two-sided document

- 1 From your application's **File** menu, select **Print**. The odd-numbered pages print first.
- 2 When the odd-numbered pages of your two-sided document are finished printing, your printer software prompts you to reload the paper.

- a When the entire stack is finished printing, remove the stack.
- b Flip the stack of paper.
- c Insert the stack of paper and instruction page with the printed side facing **away** from you and the arrows pointing **down**.

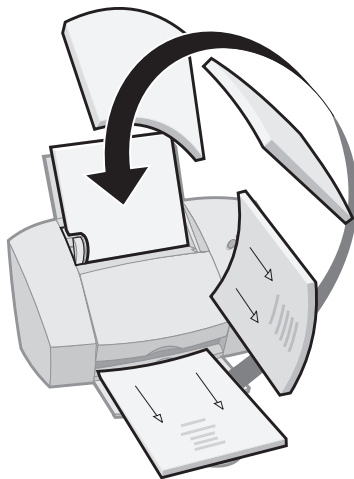

Note: *The direction of the arrows on your instruction page may be different than the instruction page shown. Always insert the stack of paper and instruction page with the arrows pointing **down**.*

- 3 Click **OK**. The even-numbered pages print on the other side.
- 4 To return to single-sided printing:
 - a From the Printer Properties, click the **Job Finishing** tab.
 - b Make sure **Two-sided printing** is **not** selected.
 - c Click **OK**.

Printing handouts

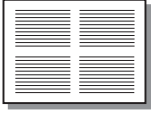

Four page images on a single sheet of paper

You can conserve paper by printing handouts or multiple page images on a single sheet of paper.

Step 1: Load the paper

Load up to 100 sheets of paper against the right side of the sheet feeder. For help, see page 2.

Step 2: Customize the printer settings for handouts

You can print your handouts on one side of the paper, or on both sides of the paper.

- 1 Open the Printer Properties. For help, see page 5.
- 2 Select the page orientation for the page images:

Note: The page orientation you select in the **Paper** tab reflects the orientation of the page image and **not** the sheet of paper the page image prints on.

- a Click the **Paper** tab.
 - b From the Orientation area, select **Portrait** or **Landscape**.
- 3 From the **Paper Size** area, select a paper size.

- 4 Customize the settings in Printer Properties for printing handouts.

Note: The screen graphic changes as you make selections, showing how the printed page will look.

a Click the **Job Finishing** tab.

b Select **Handout**.

c Select the **Number of Prints** (page images) to print on a single sheet.

d To print a border representing the paper edges for each page image, select **Print Page Borders**.

The graphic shows three **Portrait-oriented** page images with **Page Borders**.

- 5 To print your handout on one side of the paper, click **OK**.

To print your handout on both sides of the paper:

- a** Select **Two-sided printing**.
- b** To receive paper reloading instructions, select **Print reloading instructions after the first side prints**.
- c** Click **Long Edge Binding** or **Short Edge Binding**.
- d** Click **OK**.

Step 3: Print your handouts

- 1 From your application's **File** menu, select **Print**.
- 2 From the Print dialog box, click **OK** or **Print** (depending on the application).
 - If you formatted your handouts to print on one side of each page, go to step 5.
 - If you formatted your handouts for two-sided printing, continue with printing the second side of your handouts.
- 3 When the first side of all your handouts is finished printing, your printer software prompts you to reload the paper.

- a When the entire stack is finished printing, remove the stack.
- b Flip the stack of paper.
- c Insert the stack of paper and instruction page with the printed side facing **away** from you and the arrows pointing **down**.

Note: The direction of the arrows on your instruction page may be different than the instruction page shown. Always insert the stack of paper and instruction page with the arrows pointing **down**.

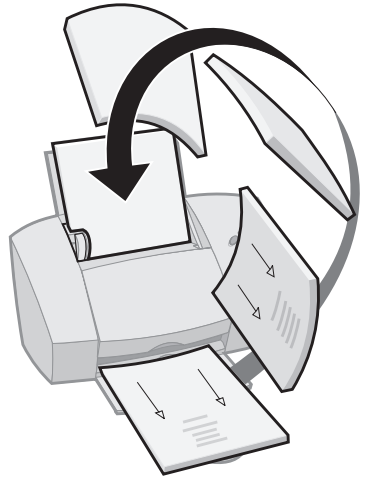

- 4 Click **OK**. The second side of all your handouts prints on the other side.
- 5 To go back to normal printing:
 - a From the **Job Finishing** tab, select **Normal**.
 - b Click **OK**.

Printing booklets



You can print and bundle your document together to make a booklet.

Step 1: Load the paper

Load up to 100 sheets of paper (depending on thickness) against the right side of the sheet feeder. For help, see page 2.

Step 2: Customize your Printer Properties

- 1 Select the correct settings in your software application:
 - a Select **Portrait** page orientation.
 - b Select from these paper sizes:
 - Statement
 - Letter
 - A4
 - A5
- 2 Open the Printer Properties. For help, see page 5.
- 3 Click the **Job Finishing** tab.
- 4 Select **Booklet**.
- 5 Select the number of **Sheets Per Bundle**.

Notes:

- A **bundle** is any number of sheets of paper folded together. For help, see page 17.
 - When printing with a heavier paper stock, select a smaller number of **Sheets Per Bundle** to allow for binding considerations.
- 6 To receive paper reloading instructions, click **Print reloading instructions after the first side prints**.
 - 7 Click **OK**.

Step 3: Print your booklet

- 1 From your application's **File** menu, select **Print**.
- 2 From the Print dialog box, click **OK** or **Print** (depending on the application).
- 3 When the first side of your booklet is finished printing, your printer software prompts you to reload the paper.
 - a When the entire stack is finished printing, remove the stack.
 - b Flip the stack of paper.
 - c Insert the stack of paper and instruction page with the printed side facing **away** from you and the arrows pointing **down**.

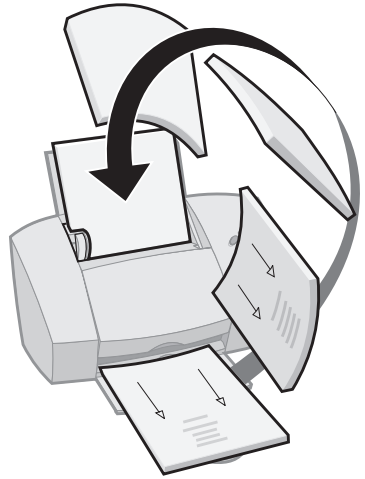

Note: *The direction of the arrows on your instruction page may be different than the instruction page shown. Always insert the stack of paper and instruction page with the arrows pointing **down**.*

- 4 Click **OK**. The second side of your booklet prints on the other side.
- 5 To go back to normal printing:
 - a From the **Job Finishing** tab, select **Normal**.
 - b Click **OK**.
- 6 Assemble your booklet. For help, see page 17.



Five bundles stacked to form a booklet.



Step 4: Build your booklet

Once your document prints, stack the bundles together and bind your booklet.

- 1 Take the first bundle from the paper exit tray, fold it in half, and set it aside.
- 2 Take the next bundle, fold it in half, and stack it on top of the first bundle.
- 3 Stack the rest of your bundles, one on top of the other, until your booklet is complete.
- 4 Bind the bundles together to complete your booklet.

Printing posters

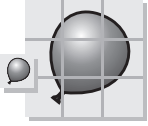

A single page enlarged to a nine page poster.

The poster finishing option is designed to print a single-page as a 4, 9, or 16-page poster. For example, you can enlarge a photograph to poster size.

Step 1: Load the paper

Load up to 100 sheets of paper against the right side of the sheet feeder and slide the paper guide next to the paper. For help, see page 2.

Note: For the best print quality, use a heavy-weight paper.

Step 2: Customize the printer settings for your poster

- 1 Open the Printer Properties. For help, see page 5.
- 2 Click the **Job Finishing** tab.
- 3 Select **Poster**.
- 4 Select your poster size.

The number you select represents the number of pages that make up the height and width of your poster. For example, if you select **4 x 4**, your printed poster is four pages high and four pages wide.



Crop marks make it easy to trim the poster pages.

- 5 Select **Show Crop Marks** if you want to print markers that show you where to easily trim (crop) the unprinted white space from the edges of the paper.
- 6 Click **OK**.

Step 3: Print and assemble your poster

- 1 From your application's **File** menu, select **Print**.
- 2 From the Print dialog box, click **OK** or **Print** (depending on your software application.)

Note: *If you need to reprint a specific page(s) of your poster, see page 20.*

- 3 On each printed page, trim the white edges from two adjacent sides.
For example, trim the white edge from the top and left sides of each page.

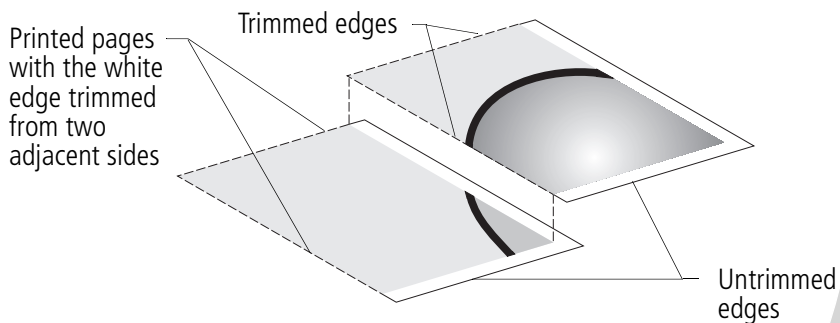

- 4 Arrange the pages so that every trimmed edge overlaps an untrimmed edge (the white edge).
- 5 Tape the back of the pages together.
- 6 To complete your poster, trim any remaining white edges.

Selecting specific pages to print

You can reprint specific pages of your poster without having to reprint all of the pages of your poster. To select specific pages to print:

- 1 From the **Job Finishing** tab, click **Select Pages to Print**.
- 2 From the Select Pages to Print screen, do one of the following:

Click **Select All** to select all the tiles, and then click the tiles you do not want to print.

or

To quickly select a few tiles to print, click **Remove All** to remove all the tiles, and then click the tiles you want to print.

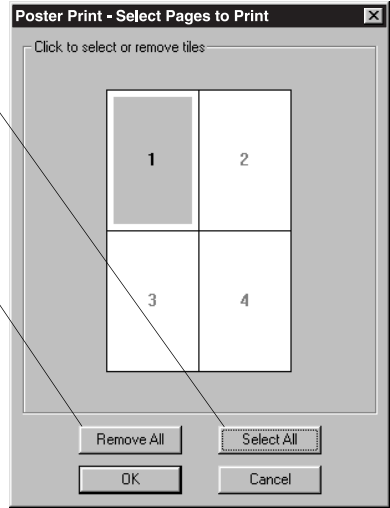

Note: In the example shown, only one page (tile **1**) is selected to print.

- 3 Click **OK**.
- 4 Print your poster page(s).
- 5 Assemble your poster. For help, see page 19.
- 6 To go back to regular printing:
 - a From the **Job Finishing** tab, select **Normal**.
 - b Click **OK**.

3

Maintaining your printer

Using the Control Program

The Control Program lets you monitor your printer and install or replace print cartridges. To open the Control Program, double-click the **Lexmark Z42 Series** printer icon on your desktop or from the **Start** menu, click:

- 1 **Programs.**
- 2 **Lexmark Z42 Series.**
- 3 **Lexmark Z42 Control Program.**

Click the...

Status tab to:

- Monitor the status of your print job.
- Cancel your print job.
- Print a test page.

Cartridges tab to:

- View your ink levels.
- Install or replace print cartridges.
- Align print cartridges for best print quality.
- Clean the print nozzles.
- View cartridge part numbers and order supplies directly from Lexmark's Web site.

About tab to find printer software version and copyright information.

DOS Printing tab to change settings for DOS printing.

Help button on any tab in the Control Program to access the printer driver Help.

Options tab to enable/disable various printer software functions, such as Sound Effects and Buffer Mode.

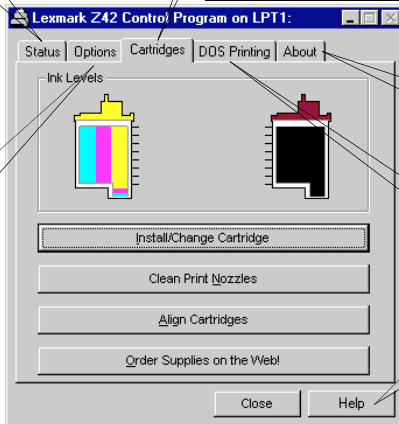

Installing or replacing print cartridges

- 1 Make sure the Power light is **On**.

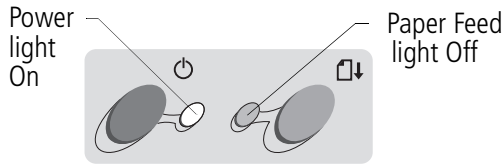

- 2 Raise the front cover. The print cartridge carrier moves to the loading position unless the printer is busy.

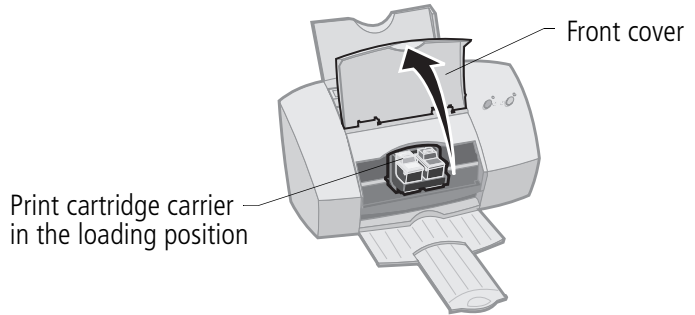

- 3 Remove the old print cartridge. Store it in an air-tight container or dispose of it.

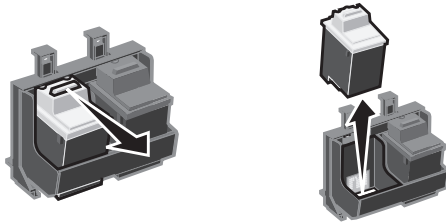

4 Install the replacement cartridge in the printer:

Warning:
DO NOT touch the gold area on the print cartridge.

If you are installing a new cartridge, remove **only** the sticker and transparent tape on the bottom of the print cartridge.

Insert the replacement print cartridge into the print cartridge carriage.

Push back firmly on the cartridge until it **snaps** securely into place.

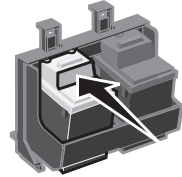
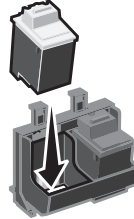
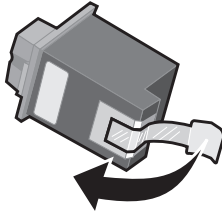

- 5** Close the front cover.
- 6** From the Control Program's **Cartridges** tab, select **Install/Change Cartridge**. For help, see page 21.
- 7** Select the cartridge type you installed and click **OK**.

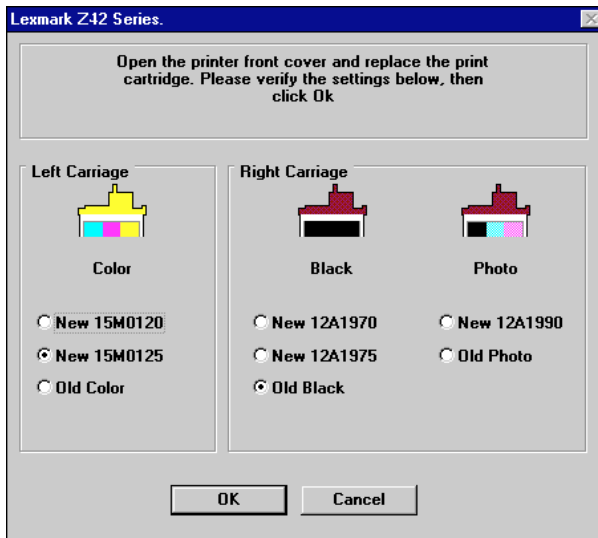

- 8** If you installed a new cartridge, the Alignment dialog box displays. Follow the instructions on the Alignment screen to complete the cartridge installation. For help, see page 24.

Improving print quality

If the print quality is not satisfactory, you may need to align your cartridges or clean the print nozzles.

Aligning print cartridges

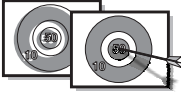

- 1 Load plain paper in the printer.
- 2 From the Control Program's **Cartridges** tab, select **Align Cartridges**. For help, see page 21.

Your printer prints an alignment test page and the Align Cartridge dialog box displays. The test page that prints has several alignment patterns, depending on the cartridge combination installed. Each pattern has a number under it. The test page that prints is similar to the one shown:

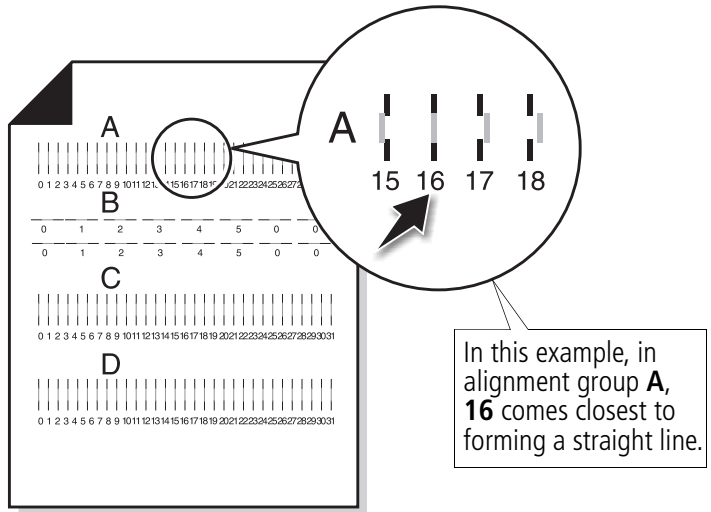

- 3 From each alignment group on the test page, find the number under the alignment pattern that comes closest to forming a straight line.
- 4 In the Align Cartridges dialog box, enter the pattern numbers from the printed test page that come closest to forming a straight line.

- 5 After you have entered a number for all of the patterns, click **OK**.

Cleaning print nozzles

- 1 Load plain paper in the printer.
- 2 From the Control Program's **Cartridges** tab, select **Clean Print Nozzles**. For help, see page 21.

The printer feeds a sheet of paper and prints a nozzle test pattern, similar to the one shown:

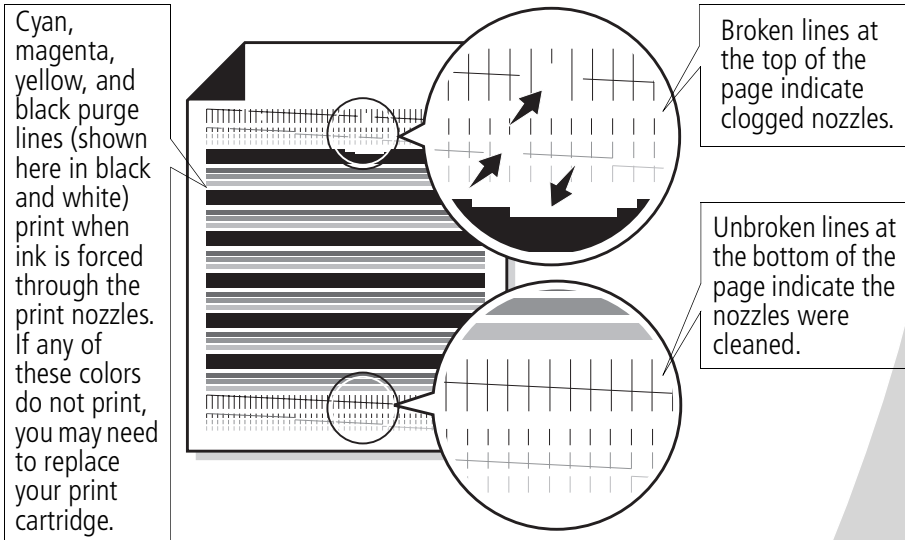

- 3 Compare the diagonal lines above the printed bars to the diagonal lines below the printed bars. Look for a break in the diagonal lines above the printed bars. Broken lines indicate clogged nozzles.
 - If the bottom lines have breaks, run the test up to two more times. If the print quality is satisfactory after running the test three times, the print nozzles are clean.
 - If the print quality of both lines is still not satisfactory, wipe the print cartridge nozzles. For help, see the next section.

Wiping print nozzles

If print quality does not improve after cleaning the print nozzles (see page 25), you may need to wipe the print nozzles. Refer to the “Troubleshooting: Print Quality” section of the printer driver Help. For help accessing the printer driver Help, see page 6.

Preserving print cartridges

To ensure the longest life from your print cartridge and optimum performance from your printer:

- Keep a new print cartridge in its packaging until you are ready to install it.
- Do not remove a print cartridge from the printer except to replace, clean, or store it in an air-tight container. The print cartridge does not print correctly if removed from the printer and left exposed for an extended period of time.
- If a print cartridge runs out of ink, leave the empty cartridge in the printer until you are ready to replace it. Printing with only one of the print cartridges in the printer may cause printer problems.

Lexmark’s printer warranty does not cover repair of failures or damage caused by a refilled cartridge. Lexmark does not recommend use of refilled cartridges. Refilling cartridges can affect print quality and cause damage to the printer. For best results, use Lexmark supplies.

4

Troubleshooting

Printer prints slowly or doesn't print
(see page 28)

From the list of printing problems in the left margin, select a category that describes your printing problem, and then read the category for the solution.

Paper misfeeds or jams
(see page 31)

When your printer has a problem, first make sure that:

- The power supply is plugged into the printer and a properly grounded electrical outlet.
- The printer is turned On.
- The printer cable is securely attached to your computer and printer.
- If you are using a parallel cable, make sure it is an IEEE 1284-compliant parallel cable that supports bidirectional printing.
- Two-way communications is enabled in your printer software.

Document prints with mistakes or poor quality
(see page 32)

1 From the printer's **Control Program**, click the **Options** tab.

2 Make sure **Disable Printer to PC Communications** is **not** selected.

Problems with transparencies, photos, or envelopes
(see page 35)

- If you are using Windows 98 or Windows 2000, your printer port is set to an LPTn port for a parallel cable, or to a USB port for a USB cable. To check your printer port and change it if necessary, follow the appropriate set of instructions:

Windows 98

1 From the **File** menu of your software application, select **Print** (or **Printer**) **Setup**.

2 Check your printer port in the Where area.

Error messages and flashing lights
(see page 36)

- 3 If you need to change your printer port to a **USB** port, uninstall and then reinstall the printer software. Follow the instructions on page 38, making sure to click **Next** on any screens.

If you need to change your printer port to an **LPTn** port, uninstall and then reinstall the printer software. Follow the instructions on page 38, making sure to click **Cancel** on any screens.

Windows 2000

- 1 From the **Start** menu, select **Settings**, and then select **Printers**.
- 2 From the Printers folder, right-click the printer icon for your printer.
- 3 Select **Properties** from the sidebar menu.
- 4 From the **Ports** tab, select **USB** or **LPTn** to change your printer port if necessary.
- 5 Click **OK**.

Printer prints slowly or doesn't print



Your printer and your computer may not be able to communicate properly.

The following events also indicate two-way communications problems:

- A message displays on your computer screen indicating your printer cannot establish bidirectional communications with your computer.
- Print cartridge ink level indicators on the **Status** or **Cartridges** tabs of the printer's Control Program are shaded.
- Error messages (such as **Printer Offline**) and job progress information do not display on your computer screen.



Before proceeding, verify that:

- The parallel or USB cable is securely attached to both the printer and the personal computer.
- The printer is plugged in and turned On.
- Your printer port is set to an LPTn port if you are using a parallel cable or to a USB port if you are using a USB cable. For help, see page 27.

If you have a switch box or other device (such as a scanner or fax) connected to the computer's parallel port, make sure it supports bidirectional communication. You may need to disconnect your printer from the switch box or other device and connect it directly to your computer.

Printer ejects a blank page after appearing to print

Make sure:

- You have removed the sticker and transparent tape on the bottom of the print cartridges. For help, see page 22.
- Your Lexmark printer is set as the default printer.

Printer is plugged in but doesn't print, or you get a Printer Offline message

Make sure:

- The printer is turned On, and the paper is loaded correctly.
- The parallel or USB cable is completely plugged into the printer.
- Your Lexmark printer is set as the default printer.



- The printer is not being held or paused. To check the printer status:
 - 1 From the Printers folder, double-click the **Lexmark Z42** icon.
 - 2 Click the **Printer** menu and make sure no check mark appears next to the **Pause Printing** option.

Print a test page. If the test page prints, the printer is functioning properly. Check your software application.

Test page does not print

Make sure:

- Your print cartridges are properly installed. For help, see page 22.
- You are using the correct cable, and it is not damaged. If you are using a parallel cable, make sure it is an IEEE 1284-compliant parallel cable that supports bidirectional printing.
- Your Lexmark printer is set as the default printer.

Printer prints very slowly

- Close any open applications not in use.
- Select **Normal (600 x 600 dpi)** or **Draft (300 x 600 dpi)** on the **Document/Quality** tab of Printer Properties. For help, see page 5.
- Consider purchasing more memory or increasing the virtual memory for your computer.

Note: Photos or documents containing graphics may take longer to print than regular text.

Paper misfeeds or jams



Paper misfeeds or multiple sheets feed

Make sure:

- You are using a paper recommended for inkjet printers.
- You do not force the paper down into the printer when you load it.
- The top edge of the paper extends above the top of the paper support if you are loading letter or A4 size paper.
- You do not load too much paper in the sheet feeder. Depending on the thickness of your paper, the sheet feeder can hold up to 100 sheets of paper.
- The paper guide is against the side of the paper and it does not cause the paper to bow in the sheet feeder.
- The printer is on a flat, level surface.

Printer does not feed envelopes

If regular paper feeds without problems, make sure:

- You are loading the envelopes correctly. For help, see page 3.
- You are using an envelope size supported by your printer, and it is selected in Printer Properties.
- Your application is designed to print envelopes. Check the user's documentation that came with your application.



Printer has a paper jam

Remove the paper from the sheet feeder. If the paper is lodged too far into the printer and can't be removed:

- 1 Press the Power button to turn the printer Off.
- 2 Pull firmly on the paper to remove it.
If you cannot reach the paper because it is too far into the printer, raise the front cover and pull the paper out.
- 3 Close the front cover.
- 4 Press the Power button to turn the printer On.
- 5 Resend your document to print.

Document prints with mistakes or poor quality



Vertical straight lines are not smooth

To improve the print quality of vertical straight lines in tables, borders, and graphs:

- Select **High (1200 x 1200 dpi)** or **Maximum (2400 x 1200 dpi)** Print Quality from the **Document/Quality** tab of Printer Properties. For help, see page 5.
- Test the cartridge alignment. For help, see page 24.
- Clean the print nozzles. For help, see page 25.

Characters are missing or unexpected

- Make sure your Lexmark printer driver is selected as the default printer.
- Your printer may have two-way communication problems. For help, see page 28.



Print is too dark or smudged

Make sure:

- You let the ink dry before handling the paper.
- The Paper Type setting in the Printer Properties matches the paper type loaded in the printer.
- The paper is straight and unwrinkled.
- The Print Quality setting is appropriate for the paper type. If you are printing on regular paper, select the **Draft (300 x 600 dpi)** Print Quality setting from the **Document/Quality** tab of Printer Properties. For help, see page 5.
- The print nozzles are clean. For help, see page 25.

Printed pages have alternating bands of light and dark print (intermittent printing)

- Make sure **Enable Buffer Mode** is selected on the **Options** tab of the Control Program. For help, see page 21.
- Select **High (1200 x 1200 dpi)** or **Maximum (2400 x 1200 dpi)** Print Quality on the **Document/Quality** tab of Printer Properties. For help, see page 5.
- Your printer may have two-way communications problems. For help, see page 28.



Print quality is poor at the left, right, top or bottom edge of page

Like other printers, your printer cannot print in the extreme left, right, top or bottom edges of a page. Use these minimum settings:

- Left and right margins:
6.35 mm (0.25 in.) each for all paper sizes except A4
For A4 size paper - 3.37 mm (0.133 in.) each
- Top and bottom margins:
Top - 1.7 mm (0.067 in.)
Bottom - 16.51 mm (0.65 in.)

Colors on the printout differ from the colors on the screen

- An ink cartridge may be out of ink or low on ink. Check the ink level graphic on the **Cartridges** tab of your printer's Control Program. For help, see page 21.
- From the **Document/Quality** tab of Printer Properties, select **Natural Color** as the Document Type. For help, see page 5.
- Use a different brand of paper. Every paper brand accepts ink differently and prints with slight color variations.
- Remove any extra devices such as a scanner, and connect the printer to the parallel port.
- Clean the print nozzles. For help, see page 25.



Colors on the printout are faded

- Your print cartridge may be low on ink. Check the ink level graphics on the **Cartridges** tab of your printer's Control Program. For help, see page 21.
- Clean the print nozzles. For help, see page 25.
- If the colors still seem faded, wipe the print nozzles. For help, see the "Troubleshooting: Print Quality" section of your printer driver Help. For help accessing the printer driver Help, see page 6.

Problems with transparencies, photos, or envelopes



Transparencies or glossy photo papers stick together

- Remove each page as it exits the printer and allow to dry completely before stacking.
- Use a transparency or photo paper designed for an inkjet printer.

Transparencies or photos contain white lines

- From the Printer Properties, select **High (1200 x 1200 dpi)** or **Maximum (2400 x 1200 dpi)** Print Quality. For help, see page 5.
- Your print nozzles may need cleaning. For help, see page 25.

Printer does not feed envelopes

For help, see page 32.

Error messages and flashing lights



Power
light

Paper
Feed
light

Paper Jam message

For help, see page 32.

Ink Low message

The print cartridge is running out of ink. Purchase a new print cartridge. For help replacing your print cartridge, see page 22.

The Power light is On and the Paper Feed light is blinking

- If the printer is out of paper:
 - 1 Load paper.
 - 2 Press the Paper Feed button.

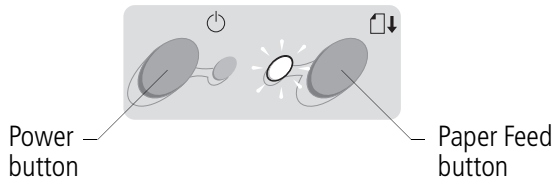

- If the printer has a paper jam, see page 32 for help.

The Power light blinks twice

The print cartridge carrier has stalled. Check your screen for any error messages.

- 1 Turn the printer Off.
- 2 Wait a few seconds, and then turn the printer back On.



Appendix

In this section, you can find information about:

- Installing printer software
- Uninstalling printer software
- Printing from DOS
- Warranty
- Notices
- Safety

Installing printer software

You can obtain the printer software using:

- the compact disc (CD-ROM) that came with your printer
- the World Wide Web
- diskettes

If your printer software does not install properly, a communications error message appears when you try to print. You may need to uninstall, and then reinstall the printer software. For help, see page 38.

Using the CD-ROM

Follow the set of instructions that corresponds to your operating system and printer cable (parallel or USB):

Windows 98 - USB cable

- 1 Start Windows.
- 2 Click **Next** when the first screen appears.
- 3 Insert the software CD.

- 4 Click **Next** or **Finish** on any subsequent screens.

The Lexmark Z42 software installation screen appears.

- 5 Click **Install Printer Software**.

Windows 95/98/NT 4.0 - parallel cable

- 1 Start Windows.
- 2 Click **Cancel** on any screens that appear.
- 3 When the desktop appears, insert the software CD.

The Lexmark Z42 software installation screen appears.

- 4 Click **Install Printer Software**.

Windows 2000 - parallel or USB cable

- 1 Start Windows.
- 2 Click **Cancel** on any screens that appear.
- 3 When the desktop appears, insert the software CD.

The Lexmark Z42 software installation screen appears.

- 4 Click **Install Printer Software**.

Note: If the CD does not run automatically when you insert it:

- 1 From the **Start** menu, select **Run**.
- 2 In the command-line text box, type the letter of your CD-ROM drive, followed by `: \setup` (for example, `d:\setup`), and then click **OK**.

Using the World Wide Web

If your computer does not have a CD-ROM drive, you can download the printer software from the World Wide Web at www.lexmark.com.

- 1 From Lexmark's Web site, select the appropriate driver for your operating system.
- 2 Select **Save to Disk**.
- 3 Select a location on your hard disk drive.
- 4 Double-click the executable (.exe) file to open it.
The Win Self-Extractor window opens.
- 5 Follow the set of instructions on your screen.

Using diskettes

If your computer does not have a CD-ROM drive, you can create driver diskettes using a friend's computer or a computer at your

Lexmark dealer that has a CD-ROM drive. You will need at least three blank 3.5 inch diskettes.

To create diskettes of the printer software:

- 1 Insert the software CD into the CD-ROM drive.

If the CD does not run automatically:

- a From the **Start** menu, select **Run**.
 - b In the command-line text box, type the letter of your CD-ROM drive, followed by **:setup** (for example, **d:\setup**), and then click **OK**.
- 2 When the Lexmark Z42 software installation screen appears, select **Tools**.
 - 3 Select **Create Diskettes**.
 - 4 Follow the instructions on the screen.

To install the printer software from diskettes:

- 1 Start Windows.
- 2 Insert Setup Disk 1 into your disk drive.
- 3 From the **Start** menu, select **Run**.
- 4 In the command-line text box, type the letter of your disk drive, followed by **:setup** (for example, **a:\setup**), and then click **OK**.
- 5 When prompted by the printer software, insert the appropriate disks into your disk drive and click **OK**.
- 6 Follow the instructions on the screen.

Ordering Diskettes

If your computer does not have a CD-ROM drive, and you do not have access to either the World Wide Web or a computer with a CD-ROM drive, you can order diskettes from our Customer Support Center for a fee. Refer to the printer registration information for the telephone number in your country.

Uninstalling printer software

If your printer software does not install properly or your printer port is not set to the correct port, you may need to uninstall, and then reinstall the printer software.

To uninstall the printer software:

- 1 From the **Start** menu, select **Programs**.
- 2 Select **Lexmark Z42 Series**.
- 3 Select **Lexmark Z42 Series Uninstall**.
- 4 Follow the instructions on your screen.

To reinstall the printer software, follow the appropriate set of instructions from "Installing printer software" on page 37.

Printing from DOS

To open your printer online Help system and find information on printing from DOS:

- 1 Open the Printer Properties (for help, see page 5) or the Control Program (for help, see page 21).
- 2 Click the **Help** button in the lower-right corner of the software screen.

- 3 At the top of the Help screen, click **Help Contents**.
- 4 Scroll down the screen to **How to...**
- 5 From the How to... topics, click **Print from Windows and DOS applications**.

Statement of Limited Warranty

Lexmark International, Inc., Lexington, KY

This warranty applies to the United States and Canada. For customers outside the U.S. and Canada, refer to the country-specific warranty information that came with your printer.

Lexmark Z42 Color Jetprinter™

This Statement of Limited Warranty applies to this product if it was originally purchased for your use, and not for resale, from Lexmark or a Lexmark remarketer, referred to in this statement as "Remarketer."

Warranty

Lexmark warrants that this product:

- Is manufactured from new parts, or new and serviceable used parts, which perform like new parts,
- Is free from defects in material and workmanship,
- Conforms to Lexmark's official published specifications, and
- Is in good working order.

If this product does not function as warranted during the warranty period, contact a Remarketer or Lexmark for repair without charge.

If this product is a feature or option, this statement applies only when that feature or option is used with the product for which it was designed. To obtain warranty service, you may be required to present the feature or option with the product.

- If you transfer this product to another user, warranty service under the terms of this statement is available to that user for the remainder of the warranty period. You should transfer proof of original purchase and this statement to that user.

Warranty Service

The warranty period is 12 months and starts on the date of original purchase as shown on the purchase receipt.

To obtain warranty service you may be required to present proof of original purchase. Warranty service will be provided at a Remarketer or a Lexmark designated location. You may be required to deliver your product to the Remarketer or Lexmark, or ship it prepaid and suitably packaged to a Lexmark designated location. You are responsible for loss of, or damage to, a product in transit to the Remarketer or the designated location.

When warranty service involves the exchange of a product or part, the item replaced becomes

the property of the Remarketer or Lexmark. The replacement may be a new or repaired item. The replacement item assumes the remaining warranty period of the original product.

Replacement is not available to you if the product you present for exchange is defaced, altered, in need of a repair not included in warranty service, or damaged beyond repair. Also, such product must be free of any legal obligation or restrictions that prevent its exchange.

Before you present this product for warranty service, remove all programs, data, and removable storage media.

For further explanation of your warranty alternatives and the nearest Lexmark authorized servicer in your area, please contact Lexmark at 1-800-539-6275, or on the World Wide Web at www.lexmark.com.

Free remote technical support is provided for this product throughout its warranty period. For products no longer covered by a Lexmark warranty, technical support may only be available for a fee.

Extent of Warranty

We do not warrant uninterrupted or error-free operation of a product.

Warranty service does not include repair of failures caused by:

- Modification or attachments
- Accidents or misuse

- Unsuitable physical or operating environment
- Maintenance by anyone other than Lexmark or a Lexmark authorized servicer
- Operation of a product beyond the limit of its duty cycle
- Failure to have installed a maintenance kit as specified (if applicable)
- Use of printing media outside of Lexmark specifications
- Use of other than Lexmark supplies (such as toner cartridges, inkjet cartridges, and ribbons)
- Use of other than Lexmark product or component

ALL EXPRESS AND IMPLIED WARRANTIES, INCLUDING THE IMPLIED WARRANTIES OF MERCHANTABILITY AND FITNESS FOR A PARTICULAR PURPOSE, ARE LIMITED IN DURATION TO THE WARRANTY PERIOD. NO WARRANTIES, EXPRESS OR IMPLIED, WILL APPLY AFTER THIS PERIOD.

Limitation of Liability

Your sole remedy under this Statement of Limited Warranty is set forth in this section. For any claim concerning performance or nonperformance of Lexmark or a Remarketer for this product under this Statement of Limited Warranty, you may recover actual damages up to the limit set forth in the following paragraph.

Lexmark's liability for actual damages from any cause whatsoever will be limited to the

greater of 1) \$5,000 or 2) the amount you paid for the product that caused the damages. This limitation of liability will not apply to claims by you for bodily injury or damage to real property or tangible personal property for which Lexmark is legally liable. In no event will Lexmark be liable for any lost profits, lost savings, incidental damage, or other economic consequential damages. This is true even if you advise Lexmark or a Remarketer of the possibility of such damages. Lexmark is not liable for any claim by you based on a third party claim.

This limitation of remedies also applies to any developer of materials supplied to Lexmark. Lexmark's and the developer's limitations of remedies are not cumulative. Such developer is an intended beneficiary of this limitation.

Additional Rights

Some states do not allow limitations on how long an implied warranty lasts, or do not allow the exclusion or limitation of incidental or consequential damages. If such laws apply, the limitations or exclusions contained in this statement may not apply to you.

This warranty gives you specific legal rights. You may also have other rights which vary from state to state.

Electronic emission notices

Federal Communications Commission (FCC) Compliance Information Statement

The Lexmark Z42 Color Jetprinter has been tested and found to comply with the limits for a Class B digital device, pursuant to Part 15 of the FCC Rules. Operation is subject to the following two conditions: (1) this device may not cause harmful interference, and (2) this device must accept any interference received, including interference that may cause undesired operation.

The FCC Class B limits are designed to provide reasonable protection against harmful interference in a residential installation. This equipment generates, uses and can radiate radio frequency energy and, if not installed and used in accordance with the instructions, may cause harmful interference to radio communications. However, there is no guarantee that interference will not occur in a particular installation. If this equipment does cause harmful interference to radio or television reception, which can be determined by turning the equipment off and on, the user is encouraged to try to correct the interference by one or more of the following measures:

- Reorient or relocate the receiving antenna.
- Increase the separation between the equipment and receiver.

- Connect the equipment into an outlet on a circuit different from that to which the receiver is connected.
- Consult your point of purchase or service representative for additional suggestions.

The manufacturer is not responsible for any radio or television interference caused by using other than recommended cables or by unauthorized changes or modifications to this equipment. Unauthorized changes or modifications could void the user's authority to operate this equipment.

Note: To assure compliance with FCC regulations on electromagnetic interference for a Class B computing device, use a properly shielded and grounded cable such as Lexmark part number 1329605 for parallel attach or 43H5856 for USB attach. Use of a substitute cable not properly shielded and grounded may result in a violation of FCC regulations.

Any questions regarding this compliance information statement should be directed to:

Director of Lab Operations
Lexmark International, Inc.
740 West New Circle Road
Lexington, KY 40550
(606) 232-3000

Industry Canada Compliance Statement

This Class B digital apparatus meets all requirements of the Canadian Interference-Causing Equipment Regulations.

Avis de conformité aux normes d'Industrie Canada

Cet appareil numérique de la classe B respecte toutes les exigences du Règlement sur le matériel brouilleur du Canada.

European Community (EC) Directives Conformity

This product is in conformity with the protection requirements of EC Council directives 89/336/EEC and 73/23/EEC on the approximation and harmonization of the laws of the Member States relating to electromagnetic compatibility and safety of electrical equipment designed for use within certain voltage limits.

A declaration of conformity with the requirements of the Directive has been signed by the Director of Manufacturing and Technical Support, Lexmark International, S.A., Boigny, France.

This product satisfies the Class B limits of EN 55022 and safety requirements of EN 60950.

Japanese VCCI Notice

この装置は、情報処理装置等電磁障害自主規制協議会（VCCI）の基準に基づいてクラスB情報技術装置です。この装置は、家庭環境で使用することを目的としていますが、この装置が少量の電磁気干渉を発生し、周辺機器に影響を及ぼす可能性があります。取扱説明書に従って正しい取り扱いをして下さい。

The United Kingdom Telecommunications Act 1984

This apparatus is approved under the approval number NS/G/1234/J/100003 for the indirect connections to the public telecommunications systems in the United Kingdom.

Energy star



The EPA ENERGY STAR Computers program is a partnership effort with computer manufacturers to promote the introduction of energy-efficient products and to reduce air pollution caused by power generation.

Companies participating in this program introduce personal computers, printers, monitors, or fax machines that power down when they are not being used. This feature will cut the energy used by up to 50 percent. Lexmark is proud to be a participant in this program.

As an Energy Star Partner, Lexmark International, Inc. has determined that this product meets the Energy Star guidelines for energy efficiency.

Power supply

If your power supply fails, replace it with the Lexmark replacement part or other UL LISTED Direct Plug-In Power Unit marked "Class 2" and rated 30 V dc at 500 mA.

Safety information

- If your product is NOT marked with this symbol , it MUST be connected to an electrical outlet that is properly grounded.
- The power cord must be connected to an electrical

outlet that is near the product and easily accessible.

- Refer service or repairs, other than those described in the operating instructions, to a professional service person.
- This product is designed, tested and approved to meet strict global safety standards with the use of specific Lexmark components. The safety features of some parts may not always be obvious. Lexmark is not responsible for the use of other replacement parts.



Index

A

- aligning
- print cartridges 24

B

- banding 33
- banners
 - loading 3
 - setting recommendations 7
- bidirectional communications
 - disabling 27
 - problems 28
- binding options
 - long edge 10
 - selecting 13
 - short edge 10
- blinking lights
 - Paper Feed 36
 - Power 36
- booklets
 - building 17
 - bundling 17
 - printing 15
- buttons
 - Paper Feed 36
 - Power 36

C

- cards
 - loading 3
 - setting recommendations 7

- cartridges, print
 - aligning 24
 - installing 22
 - part numbers 21
 - preserving 26
 - removing 22
 - replacing 22
- CD-ROM
 - installing software 37
- characters, missing or unexpected 32
- Control Program
 - using 21
- crop marks, selecting 18
- custom size paper
 - loading 4
 - setting recommendations 8

D

- default settings 7
- diskettes, installing
 - printer software 37
- DOS printing 38
- downloaded printer driver
 - installing 37
- duplexing 9

E

- electronic emission notices 40
- Energy Star 41

- envelopes
 - loading 3
 - problems 31
 - setting recommendations 7
- error messages
 - Ink Low 36
 - Paper Jam 32, 36
 - Printer Offline 29
- European Community Directives Conformity 41

F

- Federal Communications Commission Compliance Information Statement 40
- flashing lights
 - troubleshooting 36
- foils
 - See transparencies

G

- greeting cards
 - loading 3
 - setting recommendations 7

H

- halftone settings
 - adjusting 6
- handouts
 - printing 14

setting recommendations 12

I

image settings
adjusting 6
improving print quality 24
index cards
loading 3
setting recommendations 7
Industry Canada Compliance Statement 40
Ink Low message 36
installing
print cartridge 22
printer software 37
intermittent printing 33
Internet printing
Web Smoothing 6
iron-on transfers
loading 4
setting recommendations 8

J

Japanese VCCI Notice 41

L

lights
Paper Feed 36
patterns 36
Power 22
loading
paper 2
specialty papers 3
long edge binding 10

M

margins
minimum settings 34
messages, error
Ink Low 36
Paper Jam 36
Printer Offline 29

N

notices
electronic emission 40
Energy Star 41
European Community Directives Conformity 41
FCC Statement 40
Industry Canada Compliance Statement 40
Japanese VCCI Notice 41
safety information 41
warranty statement 38
nozzles, print
cleaning 25
wiping 26
n-up printing
See handouts

O

ordering supplies 21

P

paper
jams 32
loading 2
Paper Feed button 36
Paper Feed light 36
paper guide
locating 2
using 2

parallel cable
connection problems 27
specifications 27
part numbers
black cartridge 23
color cartridge 23
parallel cable 40
photo cartridge 7, 23
print cartridges 21
USB cable 40
photo cards
loading 3
setting recommendations 7
photo paper
loading 3
problems 35
setting recommendations 7
postcards
loading 3
setting recommendations 7
poster
assembling 19
printing 18
selecting specific pages 20
Power button 36
Power light 36
power supply, replacing 41
print cartridges
aligning 24
cleaning 25
installing 22
part numbers 21
preserving 26
removing 22
replacing 22
wiping nozzles 26
print nozzles
cleaning 25
wiping 26
print quality
banding 33
different colors 34

- faded colors 35
- improving 24
- missing colors 25, 34
- smudged 33
- too dark 33
- troubleshooting 32
- wavy lines 32
- printer driver
 - downloading 37
 - installing 37
 - uninstalling 38
- printer driver Help
 - accessing 6, 21
- Printer Properties
 - customizing 5
 - for booklets 15
 - for poster 18
 - for two-sided printing 10
 - opening
 - from an application 5
 - from Windows 5
 - setting recommendations 7
 - tabs 5, 6
- printer software
 - Control Program 21
 - installing 37
 - ordering diskettes 38
 - Printer Properties 5
 - uninstalling 38
- printing
 - booklets 15
 - from DOS 38
 - handouts 12
 - on both sides of the paper 9
 - posters 18
 - using Web smoothing 6
- printing last page first 6
- printing problems
 - See troubleshooting

R

- release tab 2
- removing print cartridge 22
- reverse page order 6

S

- safety information 41
- setting recommendations
 - banner paper 7
 - booklets 15
 - cards 7
 - custom size paper 8
 - envelopes 7
 - greeting cards 7
 - handouts 12
 - index cards 7
 - iron-on transfers 8
 - normal 7
 - photo cards 7
 - photo papers 7
 - postcards 7
 - poster 18
 - transparencies 8
 - two-sided printing 10
- sheet feeder 2
- Sheets Per Bundle
 - selecting 15
- short edge binding 10
- software applications
 - Control Program 21
 - Printer Properties 5
- software, printer
 - uninstalling 38
- specialty papers
 - banner paper 3
 - custom size paper 4
 - envelopes 3
 - greeting cards 3
 - index cards 3
 - iron-on transfers 4
 - loading 2
 - photo cards 3

- photo paper 3
- postcards 3
- transparencies 4
- statement of limited warranty 38
- supplies, ordering 21

T

- test page
 - alignment 24
 - does not print 30
 - nozzle test pattern 25
- transparencies
 - loading 4
 - problems 35
 - setting recommendations 8
- troubleshooting
 - blank pages 29
 - color quality 34
 - doesn't print 28
 - envelopes don't print 31
 - error messages 36
 - faded colors 35
 - flashing lights 36
 - missing colors 34
 - pages stick together 35
 - paper feed problems 31
 - paper jam 32
 - paper quality 32
 - printer software
 - installing 37
 - uninstalling 38
 - slow print 28
 - suggestions 27
 - two-way communications 28
- two-sided printing
 - reloading instructions 10
 - setting recommendations 10

two-way communications
 disabling 27
 problems 28

U

uninstalling printer software 38
United Kingdom Telecommunications Act 1984 41

W

warranty statement 38
Web Smoothing 6