

LEXMARK™

Z45 Color Jetprinter™

Online User's Guide for Mac OS X 10.0.3 to 10.1

Printer overview

Basic printing

Printing ideas

Maintenance

Troubleshooting

Notices

Index

Using this
Guide...

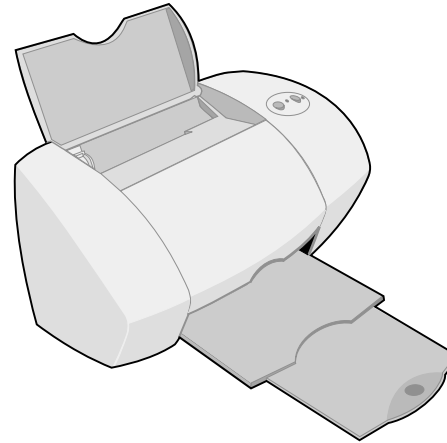

Printer overview

Basic printing

Printing ideas

Maintenance

Troubleshooting

Notices

Index

Navigating

- Click the categories in the left pane to navigate the pages.
- Click the **blue text** to link to other parts of this *Online User's Guide*.
- Click the arrows at the bottom of the screen to move forward and backward through the pages.

Searching

- 1 From the Acrobat Edit menu, choose Find.
- 2 In the Find What: box, type the word or phrase you want to search for.
- 3 Click Find.

Printing

- 1 From the Acrobat File menu, choose Page Setup.
- 2 From the Format for pop-up menu, choose Lexmark Z45, select the Landscape orientation button, and then click OK.
- 3 From the Acrobat File menu, choose Print.
- 4 From the Printer pop-up menu, choose Lexmark Z45, specify the pages you want to print, and then click Print.



Printer overview

Basic printing

Printing ideas

Maintenance

Troubleshooting

Notices

Index

Using this
Guide...

- Understanding the printer software
- Understanding the printer parts



Printer overview

Basic printing

Printing ideas

Maintenance

Troubleshooting

Notices

Index

**Using this
Guide...**

Understanding the printer software

Your printer software includes the:

- **Page Setup dialog**
- **Print dialog**
- **Lexmark Z45 Utility**

To customize the settings for your document, use the **Page Setup dialog** and the **Print dialog**. For more information on which settings to select for your document, see **Printing ideas**. When you installed the printer software, the Page Setup and Print dialogs were set to these default settings:

Print Quality: Normal

Paper Type: Plain

Paper Size: A4 or U.S. Letter

Orientation: Portrait

Printer overview

Basic printing

Printing ideas

Maintenance

Troubleshooting

Notices

Index

Using this
Guide...

Page Setup dialog

While the document you want to print is open, use the Page Setup dialog to select settings such as paper size. To customize the settings in the Page Setup dialog:

- 1 From the File menu of your software application, choose Page Setup.

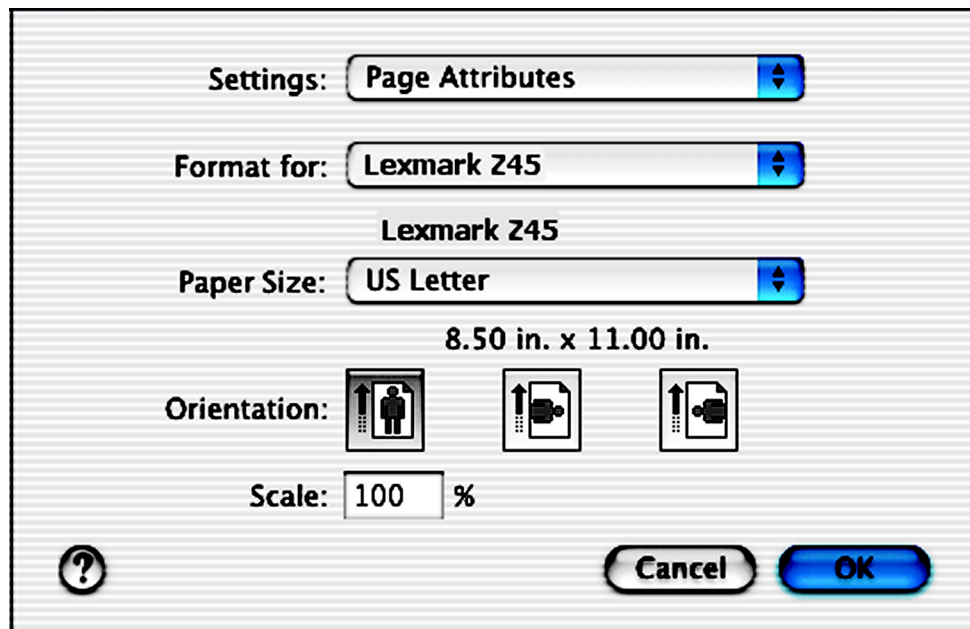

Printer overview

Basic printing

Printing ideas

Maintenance

Troubleshooting

Notices

Index

**Using this
Guide...**

2 Change the settings as needed.

From this pop-up menu:	Select:	When you want to:
Format for	Lexmark Z45	Format your page for printing with your Lexmark Z45 printer.
Settings	Page Attributes	Choose a paper size, orientation, or scaling value for your document.
	Summary	View a summary of the current page settings.

For more information about these settings, click ? to view the OS X software Help.

3 Click OK to apply the settings and close the Page Setup dialog.

Print dialog

While your document is open, you can use the Print dialog to select settings that affect the appearance of your document. To customize the settings in the Print dialog:

Printer overview

Basic printing

Printing ideas

Maintenance

Troubleshooting

Notices

Index

Using this
Guide...

- 1 From the software application File menu, choose Print.

The screenshot shows a print dialog box for a Lexmark Z45 printer. At the top, the 'Printer' dropdown menu is set to 'Lexmark Z45' and the 'Saved Settings' dropdown menu is set to 'Standard'. Below these is a section titled 'Copies & Pages' with a dropdown arrow. Inside this section, the 'Copies' field is a text box containing the number '1', and the 'Collated' checkbox is checked. The 'Pages' section has two options: 'All' (selected with a radio button) and 'From: 1 to: 1' (with radio buttons and text boxes). At the bottom of the dialog, there is a help icon (a question mark in a circle), and three buttons: 'Preview', 'Cancel', and 'Print'.

Printer overview

Basic printing

Printing ideas

Maintenance

Troubleshooting

Notices

Index

Using this
Guide...

- 2 From the Printer pop-up menu, choose Lexmark Z45.
- 3 Change the settings as needed.

From the pop-up menu, choose:	Select:	When you want to:
Copies & Pages	Copies	Specify the number of copies you want to print.
	Collated	Sort multiple copy jobs.
	All or From	Print all of the pages in a document or print a range of pages.
Layout	Pages per Sheet	Print multiple pages of your document on a single sheet of paper.
	Layout Direction	Print the pages of your document in a specified order.
	Border	Print a border around each page of your document.
Output Options	Save as PDF File	Print your document to a PDF.
Color Options	Document Color	Choose a color setting.
	Halftone	Choose a halftone setting.

Printer overview

Basic printing

Printing ideas

Maintenance

Troubleshooting

Notices

Index

Using this
Guide...

From the pop-up menu, choose:	Select:	When you want to:
Advanced Layout	Print Last Page First	Print your document in reverse page order.
	Mirror	Print your document as a mirror image.
Quality & Media	Paper Type	Choose the paper type for your document.
	Print Quality	Choose a print quality. You can choose from Quick Print, Normal, Better, or Best. Note: Normal print quality is recommended for most documents. Higher print quality settings result in better quality documents for some paper types, but take longer to print. For more information about the appropriate print quality for your document, see Printing ideas .
Printer Services	Lexmark Z45 Utility	Open the Lexmark Z45 Utility .
	Troubleshooting	View troubleshooting information in the printer software Help.
	Order Supplies	View supplies information or order supplies on the Lexmark Web site.
	Software Version	View printer software version information.

Printer overview

Basic printing

Printing ideas

Maintenance

Troubleshooting

Notices

Index

Using this
Guide...

From the pop-up menu, choose:	Select:	When you want to:
Summary		View a summary of the current print settings.
Save Custom Setting		Save the current print settings for future use.

- 4 If you want more information about the settings in the Print dialog, click ? to view Help on these items. When you are finished, click the red close button.
- 5 Click Print to apply your settings and print your document.

Printer overview

Basic printing

Printing ideas

Maintenance

Troubleshooting

Notices

Index

**Using this
Guide...**

Lexmark Z45 Utility

Use the Lexmark Z45 Utility to monitor your printer and printer supplies. You can:

- Install cartridges
- Align cartridges
- Clean print nozzles
- Select a printer
- Print a test page
- Obtain information on ordering supplies
- Obtain software version information
- Configure a network printer

Using the Lexmark Z45 Utility

- 1 From a Finder window, click Computer and then, double-click the OS X disk icon ▶ Library folder ▶ Printers folder ▶ Lexmark folder.

Printer overview

Basic printing

Printing ideas

Maintenance

Troubleshooting

Notices

Index

Using this
Guide...

- 2 Double-click the Lexmark Z45 Utility icon.

The Lexmark Z45 Utility appears.

Click the:	Select:	When you want to:
Cartridges tab	Install/Change Cartridge	Specify cartridge settings in the printer software when installing or changing a cartridge. For more information, see Replacing the print cartridge .
	Align Cartridges	Align the cartridges. For more information, see Aligning the print cartridges .
	Clean Print Nozzles	Improve print quality by cleaning clogged print nozzles. For more information, see Cleaning the print cartridge nozzles .
	Print Test Page	Print a test page to verify your printer is functioning properly.
	Order Supplies	Order supplies, such as print cartridges, from the Lexmark Web site. For more information, see Ordering supplies .
About tab		Obtain printer software version information.

Printer overview

Basic printing

Printing ideas

Maintenance

Troubleshooting

Notices

Index

Using this
Guide...

Click the:	Select:	When you want to:
Advanced menu	Select Printer	<ul style="list-style-type: none"> • Select a printer and make it the default printer. • Find the IP address for the selected printer. • Add a printer located on a remote subnet. You can add a single printer or search the subnet for all available printers. • View a list of all USB, USB print sharing, and network printers.
	Network Printer Configuration	<ul style="list-style-type: none"> • Configure an unconfigured network printer. • View a list of network printers.

- 3 To learn more about what you can do with your printer, click the ? to view the printer software Help. When you are finished, click the red close button.
- 4 Click the red close button to close the Lexmark Z45 Utility.

Printer overview

Basic printing

Printing ideas

Maintenance

Troubleshooting

Notices

Index

Using this
Guide...

Understanding the printer parts

The table on the next page describes each part.

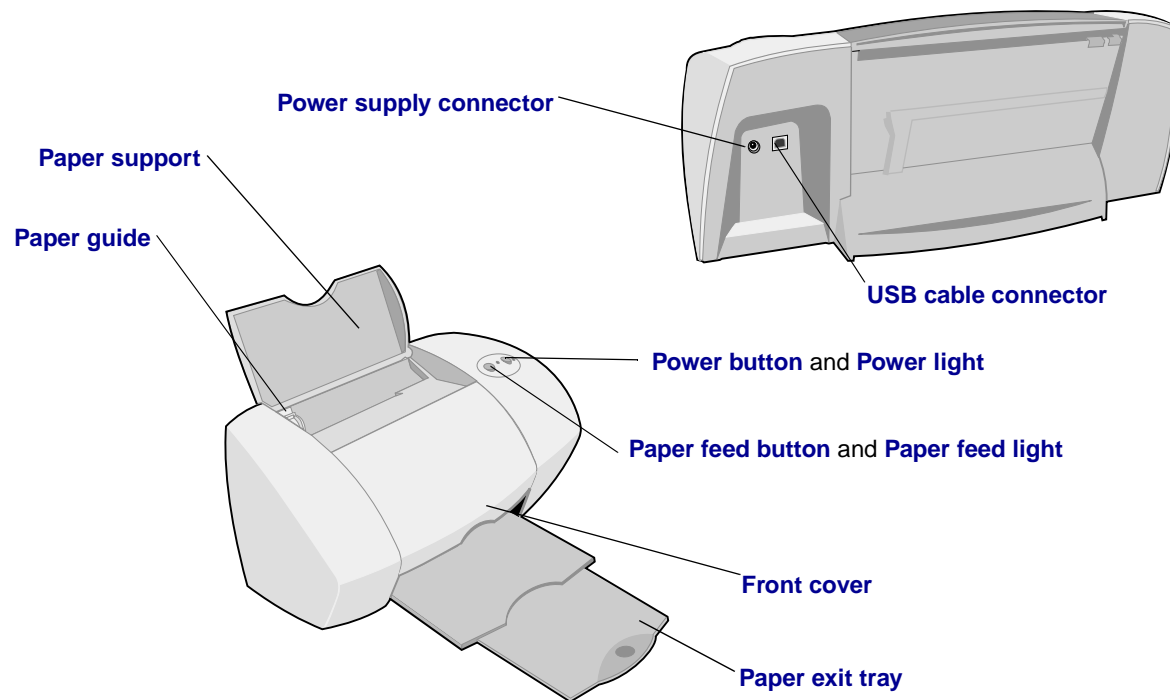

Printer overview

Basic printing

Printing ideas

Maintenance

Troubleshooting

Notices

Index

Using this
Guide...

Use this:	When you want to:
Front cover	<ul style="list-style-type: none"> • Install or change print cartridges. • Clear a paper jam.
Paper exit tray	Stack paper after printing.
Paper feed button	Eject paper from the printer.
Paper feed light	Check the printer status. For more information, see Understanding error messages and flashing lights .
Paper guide	Make sure paper feeds correctly into the printer.
Paper support	Keep paper straight in the printer.
Power button	Turn the printer on or off.
Power light	Check the printer status. For more information, see Understanding error messages and flashing lights .
Power supply connector	Connect the power supply to the printer.
USB cable connector	Connect the printer to the computer with a USB cable.

Printer overview

Basic printing

Printing ideas

Maintenance

Troubleshooting

Notices

Index

Using this
Guide...

Basic printing is as easy as:

Step 1: Load the paper

Step 2: Customize the printer settings

Step 3: Print your document

Note: For help printing on specialty paper (such as photo paper, banner paper, transparencies, or iron-on transfers), see **Printing ideas**.



[Printer overview](#)[Basic printing](#)[Printing ideas](#)[Maintenance](#)[Troubleshooting](#)[Notices](#)[Index](#)[Using this Guide...](#)

Step 1: Load the paper

You can load up to 100 sheets of paper, depending on the thickness and weight of your paper.

- 1 Make sure the paper support is upright.
- 2 Place the paper against the right side of the paper support with the print side facing you.

Note: A4 and letter size paper should extend slightly beyond the top of the paper support. Do not force the paper too far into the printer.

- 3 Squeeze and slide the paper guide to the left edge of the paper.

For information about loading specialty paper, see [Printing ideas](#).

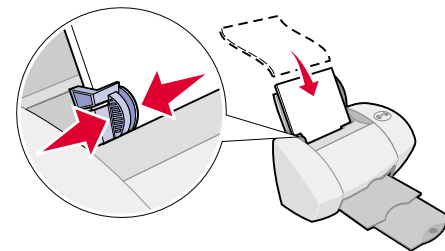

Printer overview

Basic printing

Printing ideas

Maintenance

Troubleshooting

Notices

Index

Using this
Guide...

Step 2: Customize the printer settings

If you are using plain A4 or letter size paper and you want normal print quality, you only need to adjust the paper size printer setting.

If you are using specialty paper, such as photo paper, card stock, envelopes, or banner paper, see **Printing ideas** to customize your printer settings.

For more information about the different printer settings, see **Understanding the printer software**.



Printer overview

Basic printing

Printing ideas

Maintenance

Troubleshooting

Notices

Index

Using this
Guide...

Step 3: Print your document

After you load the paper and customize the printer settings (if necessary), you are ready to print:

- 1 From the software application File menu, choose Print.
- 2 Click Print.

Note: The paper exit tray holds 50 sheets of paper. If you want to print more than 50 sheets, make sure you remove the first 50 sheets before you continue printing.



Printer overview

Basic printing

Printing ideas

Maintenance

Troubleshooting

Notices

Index

Using this
Guide...

- **Printing photos**
- **Printing on premium (coated) paper**
- **Printing cards**
- **Printing envelopes**
- **Printing color images in black and white**
- **Printing labels**
- **Printing handouts**
- **Printing iron-on transfers**
- **Printing transparencies**
- **Printing a banner**



[Printer overview](#)[Basic printing](#)[Printing ideas](#)[Maintenance](#)[Troubleshooting](#)[Notices](#)[Index](#)[Using this Guide...](#)

Printing photos

You can load up to 25 sheets of coated, photo, or glossy paper, depending on the thickness of the paper. You may want to print your photos on plain paper before loading photo paper and changing your settings. This ensures that you do not waste photo paper perfecting the image you would like to print. To print on photo cards, see [Printing cards](#).

Step 1: Load the photo paper

- If your photo paper came with instructions, read them carefully.
- Make sure your paper is not used or damaged.
- Make sure the glossy or coated side is facing you.
- Load the paper against the right side of the paper support.

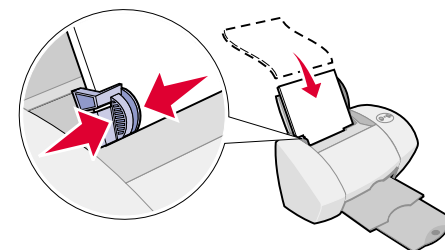

Note: Do not push the paper too far into the printer.

- Squeeze and slide the paper guide to the left edge of the paper.

Printer overview

Basic printing

Printing ideas

Maintenance

Troubleshooting

Notices

Index

Using this
Guide...

Step 2: Customize the print settings

For help, see [Understanding the printer software](#).

- 1 Choose a paper size and orientation:
 - a From the software application File menu, choose Page Setup.
 - b From the Format for pop-up menu, choose Lexmark Z45.
 - c From the Settings pop-up menu, choose Page Attributes.
 - d From the Paper Size pop-up menu, choose the paper size for your photo.
 - e Choose Portrait, Landscape, or Reverse Landscape orientation.
 - f Click OK.
- 2 Choose a paper type, print quality, and color setting:
 - a From the software application File menu, choose Print.
 - b From the Printer pop-up menu, choose Lexmark Z45.
 - c From the pop-up menu in the upper left, choose Color Options.
 - d From the Document Color pop-up menu, choose Natural.
 - e From the Halftone pop-up menu, select Airbrush.

Printer overview

Basic printing

Printing ideas

Maintenance

Troubleshooting

Notices

Index

Using this
Guide...

- f From the pop-up menu in the upper left, choose Quality & Media.
- g From the Paper Type pop-up menu, choose Glossy/Photo.
- h From the Print Quality area, click Better or Best for the print quality.

Note: Higher print quality settings result in better quality documents, but may take longer to print.

Step 3: Print your photos

Click Print.

Note: To prevent smearing, remove each photo as it exits the printer and let it dry before stacking.



Printer overview

Basic printing

Printing ideas

Maintenance

Troubleshooting

Notices

Index

Using this
Guide...

Printing on premium (coated) paper

You can load up to 100 pages of premium (coated) paper, depending on the thickness of the paper.

Step 1: Load the premium (coated) paper

- If your paper came with instructions, read them carefully.
- Make sure your paper is not used or damaged.
- Make sure the print side is facing you.
- Load the paper vertically against the right side of the paper support.

Note: Do not push the paper too far into the printer.

- Squeeze and slide the paper guide to the left edge of the paper.

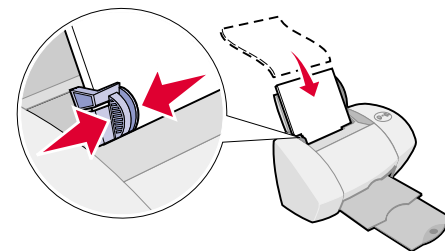

Printer overview

Basic printing

Printing ideas

Maintenance

Troubleshooting

Notices

Index

Using this
Guide...

Step 2: Customize the print settings

For help, see [Understanding the printer software](#).

- 1 Choose a paper size and orientation:
 - a From the software application File menu, choose Page Setup.
 - b From the Format for pop-up menu, choose Lexmark Z45.
 - c From the Settings pop-up menu, choose Page Attributes.
 - d From the Paper Size pop-up menu, choose the paper size for your document.
 - e Choose Portrait, Landscape, or Reverse Landscape orientation.
 - f Click OK.
- 2 Choose a paper type and print quality:
 - a From the software application File menu, choose Print.
 - b From the printer pop-up menu, choose Lexmark Z45.
 - c From the pop-up menu in the upper left, choose Quality & Media.
 - d From the Paper Type pop-up menu, choose Plain.
 - e From the Print Quality area, choose Better or Best.

Printer overview

Basic printing

Printing ideas

Maintenance

Troubleshooting

Notices

Index

Using this
Guide...

Note: Higher print quality settings result in better quality documents, but may take longer to print.

Step 3: Print your document

Click Print.

Note: The paper exit tray holds up to 50 sheets of premium paper. To print more than 50 pages, remove the first 50 sheets from the paper exit tray, and then continue printing.



Printer overview

Basic printing

Printing ideas

Maintenance

Troubleshooting

Notices

Index

Using this
Guide...

Printing cards

You can load up to 10 greeting cards, index cards, photo cards, or postcards into the paper support, depending on the thickness of the cards.

Step 1: Load the cards

- If your cards came with instructions, read them carefully.
- Make sure your cards are not used or damaged.
- Make sure the print side is facing you.
- Load the cards vertically against the right side of the paper support.

Note: Do not push the cards too far into the printer.

- Squeeze and slide the paper guide to the left edge of the cards.

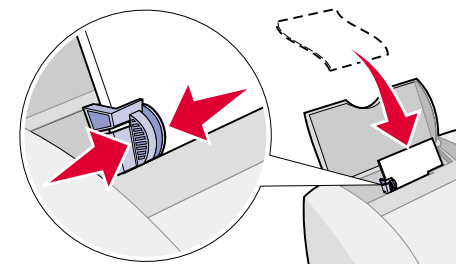

Printer overview

Basic printing

Printing ideas

Maintenance

Troubleshooting

Notices

Index

Using this
Guide...

Step 2: Customize the print settings

For help, see [Understanding the printer software](#).

- 1 Choose a paper size and orientation:
 - a From the software application File menu, choose Page Setup.
 - b From the Format for pop-up menu, choose Lexmark Z45.
 - c From the Settings pop-up menu, choose Page Attributes.
 - d From the Paper Size pop-up menu, choose the card size for your document.
 - e Choose Portrait, Landscape, or Reverse Landscape orientation.
 - f Click OK.
- 2 Choose a print quality and paper type:
 - a From the software application File menu, choose Print.
 - b From the Printer pop-up menu, choose Lexmark Z45.
 - c From the pop-up menu in the upper left, choose Quality & Media.
 - d Choose:
 - Glossy/Photo Paper paper type for photo cards or Plain for other types of cards

Printer overview

Basic printing

Printing ideas

Maintenance

Troubleshooting

Notices

Index

Using this
Guide...

- Better or Best print quality for photo and greeting cards or Normal for other types of cards

Note: Higher print quality settings result in better quality documents, but may take longer to print.

Step 3: Print your cards

Click Print.

Note: Remove each card as it exits the printer and let it dry before stacking.



Printer overview

Basic printing

Printing ideas

Maintenance

Troubleshooting

Notices

Index

Using this
Guide...

Printing envelopes

You can load up to 10 envelopes, depending on the thickness of the envelopes.

Step 1: Load the envelopes

Note: Do not use envelopes with holes, windows, deep embossing, metal clasps, string ties, or metal folding bars.

- Make sure your envelopes are not used or damaged.
- Make sure the print side is facing you.
- Make sure the stamp location is in the upper left corner.
- Load the envelopes vertically against the right side of the paper support.

Note: Do not push the envelopes too far into the printer.

- Squeeze and slide the paper guide to the left edge of the envelopes.

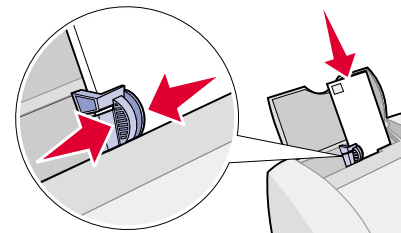

Printer overview

Basic printing

Printing ideas

Maintenance

Troubleshooting

Notices

Index

Using this
Guide...

Step 2: Customize the print settings

For help, see [Understanding the printer software](#).

- 1 Choose an envelope size and orientation:
 - a From the software application File menu, choose Page Setup.
 - b From the Format for pop-up menu, choose Lexmark Z45.
 - c From the Settings pop-up menu, choose Page Attributes.
 - d Select Paper Size to choose the appropriate envelope size.
 - e Choose Landscape orientation.

Note: Many software applications are designed to override the envelope settings in Page Setup. Make sure Landscape orientation is also selected in your software application.

- f Click OK.
- 2 Choose a print quality and paper type:
 - a From the software application File menu, choose Print.
 - b From the Printer pop-up menu, choose Lexmark Z45.



Printer overview

Basic printing

Printing ideas

Maintenance

Troubleshooting

Notices

Index

Using this
Guide...

- c From the pop-up menu in the upper left, choose Quality & Media.
- d From the Print Quality area, choose Normal print quality.
- e Choose Plain for the paper type.

Step 3: Print your envelopes

Click Print.

Note: The paper exit tray holds up to 10 envelopes. To print more than 10 envelopes, remove the first 10 envelopes from the paper exit tray before the others print.



Printer overview

Basic printing

Printing ideas

Maintenance

Troubleshooting

Notices

Index

Using this
Guide...

Printing color images in black and white

You can print color images in black ink.

Step 1: Load the paper

- Make sure your paper is not used or damaged.
- Make sure the print side is facing you.
- Load the paper vertically against the right side of the paper support.

Note: Do not push the paper too far into the printer.

- Squeeze and slide the paper guide to the left edge of the paper.

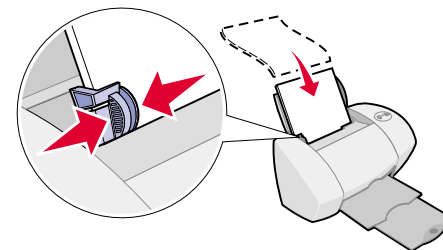

Printer overview

Basic printing

Printing ideas

Maintenance

Troubleshooting

Notices

Index

Using this
Guide...

Step 2: Customize the print settings

For help, see [Understanding the printer software](#).

- 1 From the software application File menu, choose Print.
- 2 From the Printer pop-up menu, choose Lexmark Z45.
- 3 From the pop-up menu in upper left, choose Color Options.
- 4 From the Document Color pop-up menu, choose Black Only.
- 5 Continue customizing your document following the steps in [Basic printing](#) or [Printing ideas](#) or continue with the next step.

Step 3: Print your document

Click Print.

Note: The paper exit tray holds up to 50 sheets of paper or 10 photo cards. To print more than 50 sheets of paper, remove the first 50 sheets from the paper exit tray before the others print. To print more than 10 photo cards, remove the first 10 cards from the paper exit tray before the others print.

Printer overview

Basic printing

Printing ideas

Maintenance

Troubleshooting

Notices

Index

Using this
Guide...

Printing labels

You can load up to 25 sheets of labels, depending on the thickness of the sheets.

Step 1: Load the labels

- Use only labels designed for inkjet printers.
- If your labels came with instructions, read them carefully.
- Make sure your labels are not used or damaged.
- Do not print within 1 mm (0.04 in.) of the edge of a label.
- Make sure there are no missing or curled labels.
- Make sure the print side is facing you.
- Load the labels vertically against the right side of the paper support.

Note: Do not push the label sheets too far into the printer.

- Squeeze and slide the paper guide to the left edge of the sheet of labels.

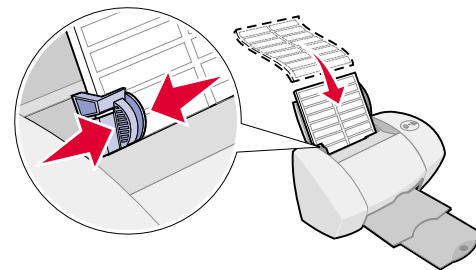

Printer overview

Basic printing

Printing ideas

Maintenance

Troubleshooting

Notices

Index

Using this
Guide...

Step 2: Customize the print settings

For help, see [Understanding the printer software](#).

- 1 Choose a paper size and orientation:
 - a From the software application File menu, choose Page Setup.
 - b From the Format for pop-up menu, choose Lexmark Z45.
 - c From the Settings pop-up menu, choose Page Attributes.
 - d Select Paper Size to choose A4 or U.S. Letter.
 - e Choose Portrait or Landscape orientation.
 - f Click OK.
- 2 Choose a print quality and paper type:
 - a From the software application File menu, choose Print.
 - b From the Printer pop-up menu, choose Lexmark Z45.
 - c From the pop-up menu in the upper left, choose Quality & Media.
 - d From the Print Quality area, select Normal.
 - e From the Paper Type area, choose Plain.

Printer overview

Basic printing

Printing ideas

Maintenance

Troubleshooting

Notices

Index

Using this
Guide...

Note: Higher print quality settings result in better quality documents, but may take longer to print.

Step 3: Print your labels

Click Print.

Note: The paper exit tray holds up to 10 sheets of labels. To print more than 10 sheets, remove the first 10 sheets from the paper exit tray before the others print.



Printer overview

Basic printing

Printing ideas

Maintenance

Troubleshooting

Notices

Index

Using this
Guide...

Printing handouts

You can conserve paper by printing handouts. Handouts are multiple page images on a single sheet of paper. You can load up to 100 sheets of paper, depending on the thickness of the paper.

Step 1: Load the paper

- If your paper came with instructions, read them carefully.
- Make sure your paper is not used or damaged.
- Make sure the print side is facing you.
- Load the paper vertically against the right side of the paper support.

Note: Do not push the paper too far into the printer.

- Squeeze and slide the paper guide to the left edge of the paper.

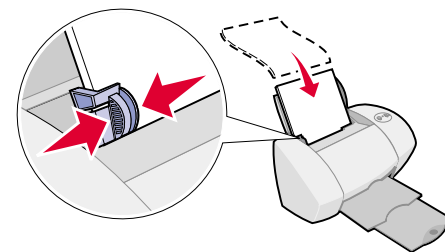

Printer overview

Basic printing

Printing ideas

Maintenance

Troubleshooting

Notices

Index

Using this
Guide...

Step 2: Customize the print settings

For help, see [Understanding the printer software](#).

You can print your handouts on one side or on both sides of the paper.

- 1 Choose a paper size and orientation:
 - a From the software application File menu, choose Page Setup.
 - b From the Format for pop-up menu, choose Lexmark Z45.
 - c From the Settings pop-up menu, choose Page Attributes.
 - d Select Paper Size to choose the paper size of your document.
 - e Choose Portrait, Landscape, or Reverse Landscape orientation.
 - f Click OK.
- 2 Choose a print quality and paper type:
 - a From the software application File menu, choose Print.
 - b From the Printer pop-up menu, choose Lexmark Z45.
 - c From the pop-up menu in the upper left, choose Quality & Media.
 - d Select a paper type for your document.

Printer overview

Basic printing

Printing ideas

Maintenance

Troubleshooting

Notices

Index

Using this
Guide...

- e Select a print quality for your document.
- f From the pop-up menu in the upper left, select Layout.
- g From the Pages per sheet pop-up menu, choose the number of pages you want to print on one sheet.
- h From the Layout Direction area, click the graphic that shows the order you want the pages to print on the sheet.
- i If you want to print a border around each image, choose an option from the Border pop-up menu.

Step 3: Print your handouts

Click Print.

[Printer overview](#)[Basic printing](#)[Printing ideas](#)[Maintenance](#)[Troubleshooting](#)[Notices](#)[Index](#)[Using this Guide...](#)

Printing iron-on transfers

You can load up to 25 iron-on transfers, depending on the thickness of the iron-on transfers. You may want to print your image on plain paper before printing it on an iron-on transfer. This ensures you do not waste iron-on transfers perfecting the image you would like to print. When the image prints to your satisfaction, load the iron-on transfers.

Step 1: Load the iron-on transfers

- If your transfers came with instructions, read them carefully.
- Make sure your transfers are not used or damaged.
- Make sure the print (blank) side is facing you.
- Load the iron-on transfers vertically against the right side of the paper support.

Note: Do not push the iron-on transfers too far into the printer.

- Squeeze and slide the paper guide to the left edge of the iron-on transfers.

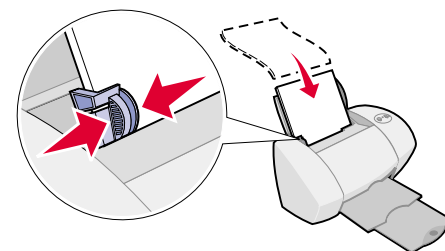

Printer overview

Basic printing

Printing ideas

Maintenance

Troubleshooting

Notices

Index

Using this
Guide...

Step 2: Customize the print settings

For help, see [Understanding the printer software](#).

- 1 Choose a paper size:
 - a From the software application File menu, choose Page Setup.
 - b From the Format for pop-up menu, choose Lexmark Z45.
 - c From the Settings pop-up menu, choose Page Attributes.
 - d Select Paper Size to choose a paper size.
 - e Choose Portrait, Landscape, or Reverse Landscape orientation.
 - f Click OK.
- 2 Choose a paper type and print quality:
 - a From the software application File menu, choose Print.
 - b From the Printer pop-up menu, choose Lexmark Z45.
 - c From the pop-up menu in the upper left, choose Quality & Media.
 - d Click Normal for the print quality.

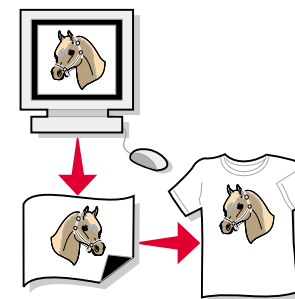

Printer overview

Basic printing

Printing ideas

Maintenance

Troubleshooting

Notices

Index

Using this
Guide...

- e From the Paper Type pop-up menu, choose Iron-On Transfer.

Note: Choosing Iron-On Transfer automatically mirrors the image you want to print. Make sure you **do not** select an option from your software application that will mirror your image.

- f If your software application also mirrors the image, follow these steps:
 - From the pop-up menu in the upper left, choose Advanced Layout.
 - Make sure Mirror is not checked.

Step 3: Print your iron-on transfers

Click Print.

Note: To prevent smudging, remove each iron-on transfer as it exits the printer and let it dry before stacking.



Printer overview

Basic printing

Printing ideas

Maintenance

Troubleshooting

Notices

Index

Using this
Guide...

Printing transparencies

You can load up to 10 transparencies, depending on the thickness of the transparencies.

Step 1: Load the transparencies

- Use transparencies designed for inkjet printers.
 - If the transparencies have paper backing sheets, make sure you separate the paper from the transparencies before you load them.
 - Make sure your transparencies are not used or damaged.
 - If your transparencies came with instructions, read them carefully.
 - Make sure the rough (print) side of the transparencies is facing you. If the transparencies have a removable strip, make sure each strip faces away from you and down.
 - Load the transparencies vertically against the right side of the paper support.
- Note:** Do not push the transparencies too far into the printer.
- Squeeze and slide the paper guide to the left edge of the transparencies.

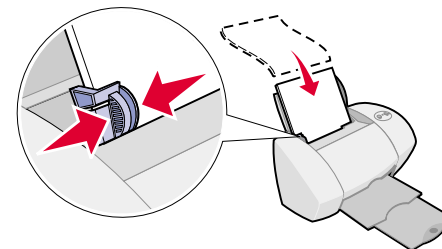

Printer overview

Basic printing

Printing ideas

Maintenance

Troubleshooting

Notices

Index

Using this
Guide...

Step 2: Customize the print settings

For help, see [Understanding the printer software](#).

- 1 Choose a paper size:
 - a From the software application File menu, choose Page Setup.
 - b From the Format for pop-up menu, choose Lexmark Z45.
 - c From the Settings pop-up menu, choose Page Attributes.
 - d Choose a paper size.
 - e Click OK.
- 2 Choose a paper type and print quality:
 - a From the software application File menu, choose Print.
 - b From the Printer pop-up menu, choose Lexmark Z45.
 - c From the pop-up menu, choose Quality & Media.
 - d From the Paper Type pop-up menu, choose Transparency.
 - e Click Normal or Better for the print quality.



Printer overview

Basic printing

Printing ideas

Maintenance

Troubleshooting

Notices

Index

Using this
Guide...

Note: Higher print quality settings result in better quality documents, but may take longer to print.

Step 3: Print your transparencies

Click Print.

Note: To prevent smudging, remove each transparency as it exits the printer and let it dry before stacking. Transparencies may require up to 15 minutes to dry.



Printer overview

Basic printing

Printing ideas

Maintenance

Troubleshooting

Notices

Index

Using this
Guide...

Printing a banner

Note: Some software applications and some operating systems do not support banner printing.

Step 1: Load the banner paper

Make sure your banner paper is not used or damaged.

- 1 Remove any paper from the paper support.
- 2 Tear off enough pages for the banner including one extra sheet, and then place them behind the printer.
- 3 Load the unattached leading edge of the first page into the printer, with the right side against the paper support.

Note: Forcing the paper too far into the printer may cause a paper jam. For help, see [Clearing paper misfeeds or jams](#).

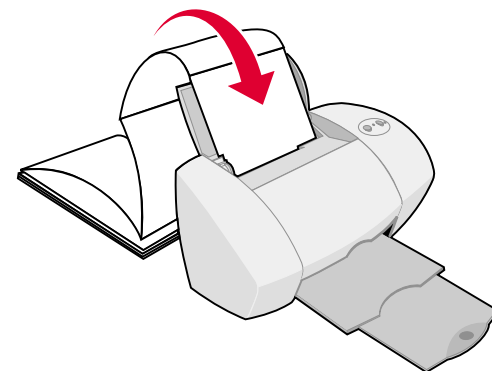
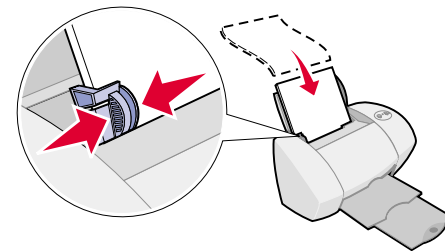

Printer overview

Basic printing

Printing ideas

Maintenance

Troubleshooting

Notices

Index

Using this
Guide...

- 4 Squeeze and slide the paper guide to the left edge of the banner paper.

Step 2: Customize the print settings

For help, see [Understanding the printer software](#).

- 1 Choose a paper size and orientation:
 - a From the software application File menu, choose Page Setup.
 - b From the Format for pop-up menu, choose Lexmark Z45.
 - c From the Settings pop-up menu, choose Page Attributes.
 - d Choose a paper size, either Banner A4 or Banner Letter.

Note: If you do not choose the correct paper size, the banner paper may cause a paper jam. For help, see [Clearing paper misfeeds or jams](#).

- e Choose Portrait or Landscape orientation.
 - f Click OK.
- 2 Choose a paper type and print quality:
 - a From the software application File menu, choose Print.
 - b From the printer pop-up menu, choose Lexmark Z45.

Printer overview

Basic printing

Printing ideas

Maintenance

Troubleshooting

Notices

Index

Using this
Guide...

- c From the pop-up menu in the upper left, choose Quality & Media.
- d Select Plain for the paper type.
- e Select Normal for the print quality.

Step 3: Print your banner

- 1 Click Print.
- 2 When the banner is finished printing:
 - a Press the paper feed button to feed any extra paper through the printer.
 - b Tear the banner paper on the perforated line (if there is any extra paper).

Printer overview

Basic printing

Printing ideas

Maintenance

Troubleshooting

Notices

Index

Using this
Guide...

- Replacing the print cartridge
- Aligning the print cartridges
- Cleaning the print cartridge nozzles
- Wiping the print cartridge nozzles and contacts
- Preserving the print cartridges
- Ordering supplies



Printer overview

Basic printing

Printing ideas

Maintenance

Troubleshooting

Notices

Index

Using this
Guide...

Replacing the print cartridge

Before you install a new or replacement print cartridge, remove the used one.

Removing the used cartridge

- 1 Make sure the power light is on.
- 2 Raise the front cover.

The cartridge carrier moves to the loading position, unless the printer is busy.

- 3 Remove the used cartridge. Store it in an airtight container or dispose of it properly.

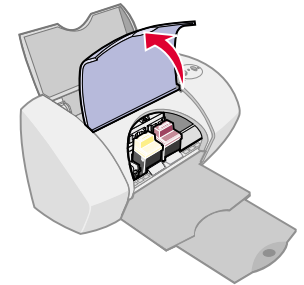

[Printer overview](#)[Basic printing](#)[Printing ideas](#)[Maintenance](#)[Troubleshooting](#)[Notices](#)[Index](#)[Using this Guide...](#)

Installing a cartridge

For best results, use Lexmark supplies. Refilling print cartridges can affect print quality and cause damage to the printer.

Your printer came with:	You can print with:
Color cartridge (P/N 15M0120)	<ul style="list-style-type: none">• A black cartridge in the right carrier and a color cartridge in the left carrier.
Black cartridge (P/N 12A1970)	<ul style="list-style-type: none">• A photo cartridge* in the right carrier and a color cartridge in the left carrier.

* You can purchase a photo cartridge (P/N 12A1990) separately.

- 1 If you are installing a new cartridge, remove the sticker and transparent tape from the back and bottom of the cartridge.

Warning: Do **not** touch or remove the gold contact areas on the back and bottom of the cartridge.

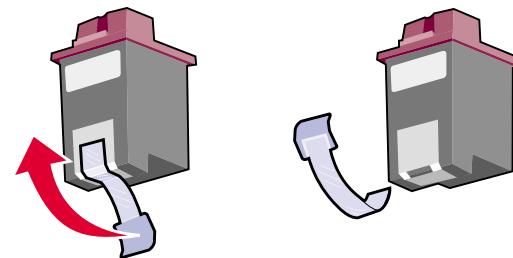

Printer overview

Basic printing

Printing ideas

Maintenance

Troubleshooting

Notices

Index

Using this
Guide...

2 Open the front cover.

Note: The cartridge carrier moves to the loading position.

3 Insert the color cartridge in the left carrier. Insert the black cartridge in the right carrier.

4 Snap the cartridges into place.

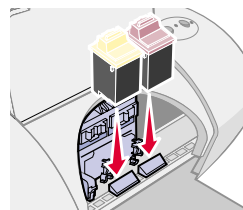

5 Close the front cover.

Note: The front cover must be closed to start a new print job.

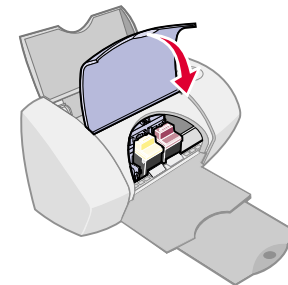
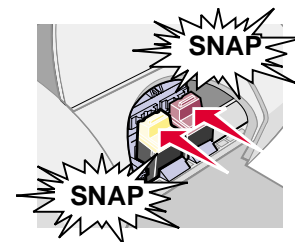
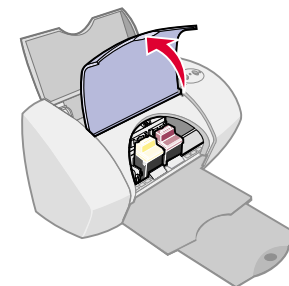

Printer overview

Basic printing

Printing ideas

Maintenance

Troubleshooting

Notices

Index

Using this
Guide...

Specifying cartridge settings in the printer software

Before you specify the print cartridge settings in the printer software, install the cartridges. For help, see [Installing a cartridge](#).

- 1 After you install the cartridge, from a Finder window, click Computer, and then double-click the OS X disk icon ▶ Library folder ▶ Printers folder ▶ Lexmark folder.
- 2 Double-click the Lexmark Z45 Utility icon.
- 3 Click the Install/Change Cartridge button.
- 4 Choose the type of cartridge you installed.
- 5 **Important:** For correct ink levels, specify whether the cartridge is a New Cartridge or an Old Cartridge.
- 6 Click OK.
- 7 Choose to automatically or manually align the cartridges.
- 8 Click Continue to print an alignment page.
- 9 Follow the instructions on the screen to complete cartridge alignment. For help, see [Aligning the print cartridges](#).

Printer overview

Basic printing

Printing ideas

Maintenance

Troubleshooting

Notices

Index

Using this
Guide...

Aligning the print cartridges

Typically, you only align print cartridges after installing or replacing a cartridge. However, you may also need to align cartridges when:

- Characters are improperly formed or are misaligned at the left margin.
- Vertical, straight lines are wavy.

To align the cartridges:

- 1 Load plain paper. For help, see [Load the paper](#).
- 2 From a Finder window, click Computer, and then double-click the OS X disk icon ▶ Library folder ▶ Printers folder ▶ Lexmark folder.
- 3 Double-click the Lexmark Z45 Utility icon.
- 4 From the Cartridges tab, click Align Cartridges.

The Cartridge Alignment dialog appears.

- 5 Decide how you want to align the cartridges:
 - If you choose Automatic Alignment (recommended), the printer determines the best alignment and automatically aligns the cartridges.
 - If you choose Manual Alignment, you must select the best alignment values from the printed page.

Printer overview

Basic printing

Printing ideas

Maintenance

Troubleshooting

Notices

Index

Using this
Guide...

- a If you chose to manually align the cartridges, find the number under the darkest arrow for each alignment group.
- b Use the arrows in the Align Cartridges dialog to select the number that matches the darkest arrow on the printed page for each alignment group, and then click OK.

If the alignment page does not print, make sure you have completely removed the sticker and transparent tape from both cartridges. For help, see **Installing a cartridge**.



Printer overview

Basic printing

Printing ideas

Maintenance

Troubleshooting

Notices

Index

Using this
Guide...

Cleaning the print cartridge nozzles

To improve print quality, you may need to clean the print cartridge nozzles. Clean the nozzles when:

- Characters are not printing completely.
- White dashes appear in graphics or printed text.
- Print is smudged or too dark.
- Vertical, straight lines are not smooth.
- Colors on print jobs are faded or they differ from the colors on the screen.

To clean the nozzles:

- 1 Load paper. For help, see [Load the paper](#).
- 2 Open the [Lexmark Z45 Utility](#).
- 3 On the Cartridges tab, click Clean Print Nozzles.
A nozzle page prints, forcing ink through the nozzles to clean any that are clogged.
- 4 Print your document again to verify your print quality has improved.
- 5 To further improve print quality, try [Wiping the print cartridge nozzles and contacts](#), and then print your document again. If the print quality has not improved, try [Cleaning the print cartridge nozzles](#) up to two more times.

[Printer overview](#)[Basic printing](#)[Printing ideas](#)[Maintenance](#)[Troubleshooting](#)[Notices](#)[Index](#)[Using this Guide...](#)

Wiping the print cartridge nozzles and contacts

If the print quality does not improve after [Cleaning the print cartridge nozzles](#), there may be dried ink on the nozzles or contacts.

- 1 Remove the print cartridge. For help, see [Replacing the print cartridge](#).
- 2 Dampen a clean, lint-free cloth with water.
 - a Hold the damp cloth against the nozzles for about three seconds. Gently blot and wipe dry in one direction.
 - b Hold a clean section of cloth against the contacts for about three seconds. Gently blot and wipe dry in one direction.

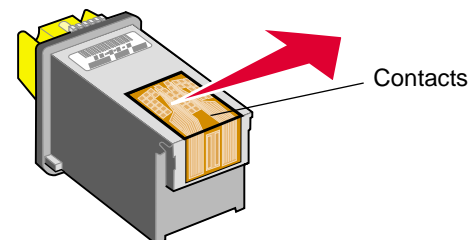
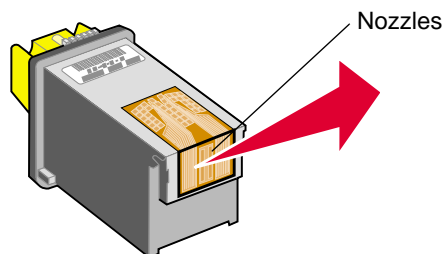

- 3 Allow the nozzles and contacts to dry completely.
- 4 Reinstall the print cartridges, and then print your document again.

Printer overview

Basic printing

Printing ideas

Maintenance

Troubleshooting

Notices

Index

Using this
Guide...

- 5 If the print quality has not improved, try **Cleaning the print cartridge nozzles** up to two more times.
- 6 If print quality is still unsatisfactory, replace your print cartridges. For help, see **Replacing the print cartridge**.



Printer overview

Basic printing

Printing ideas

Maintenance

Troubleshooting

Notices

Index

Using this
Guide...

Preserving the print cartridges

To ensure the longest life from your print cartridges and optimum performance from your printer:

- Keep a new cartridge in its packaging until you are ready to install it.
- Do not remove a cartridge from the printer except to replace it, clean it, or store it in an airtight container. The cartridge will not print correctly if left exposed for an extended period of time.

Lexmark's printer warranty does not cover repair of failures or damage caused by a refilled cartridge. Lexmark does not recommend use of refilled cartridges. Refilling cartridges can affect print quality and cause damage to the printer. For best results, use Lexmark supplies.

Printer overview

Basic printing

Printing ideas

Maintenance

Troubleshooting

Notices

Index

Using this
Guide...

Ordering supplies

To order supplies or locate a dealer near you, contact the Lexmark Web site at www.lexmark.com.

Item:	Part number:
Color cartridge	15M0120 or 15M0125
Black cartridge	12A1970 or 12A1975
Photo cartridge (optional)	12A1990
USB cable	12A2405



Printer overview

Basic printing

Printing ideas

Maintenance

Troubleshooting

Notices

Index

Using this
Guide...

- Solving general printing problems
- Solving printer software installation problems
- Solving network printing problems
- Understanding error messages and flashing lights
- Resolving unsuccessful or slow printing
- Clearing paper misfeeds or jams
- Improving print quality
- Solving specialty paper problems
- Alignment page does not print



Printer overview

Basic printing

Printing ideas

Maintenance

Troubleshooting

Notices

Index

Using this
Guide...

Solving general printing problems

When you have a printing problem, first make sure:

- The power supply is plugged into the printer and a properly grounded electrical outlet.
- Both the computer and the printer are on. If you are using your printer on a network, make sure your computer is connected to the network, your Lexmark adapter is on, and all indicator lights are on. For more information, refer to the adapter documentation.
- No printer lights are blinking. For help, see **Understanding error messages and flashing lights**.
- The printer software is installed correctly:
 - a From a Finder window, click Computer ▶ OS X disk ▶ Library ▶ Printers ▶ Lexmark.
 - b If there is not a Lexmark Z45 Utility, install the printer software.
- The paper is loaded correctly. For help, see **Load the paper**.
- You installed the cartridges correctly. For help, see **Replacing the print cartridge**.
- The printer is set as the default or current printer.

To set the printer to be the default printer:

Printer overview

Basic printing

Printing ideas

Maintenance

Troubleshooting

Notices

Index

Using this
Guide...

- a From the Finder, click the Applications icon.
- b From the Applications folder, double-click the Utilities folder, and then double-click Print Center.
- c If necessary, from the Printer menu, click View Printer List.
- d Highlight the Lexmark Z45 in the list.
- e In the Printers menu, select Make Default.

To set the printer to be the current printer:

- a From the software application File menu, choose Print.
 - b From the Format for pop-up menu, choose Lexmark Z45.
- The printer is connected directly to your computer, a network connection, or through a Lexmark adapter.

After you check all of the previous items, try **Printing a test page**.

Printer overview

Basic printing

Printing ideas

Maintenance

Troubleshooting

Notices

Index

Using this
Guide...

Printing a test page

- 1 From a Finder window, click Computer, and then double-click the OS X disk icon ▶ Library folder ▶ Printers folder ▶ Lexmark folder.
- 2 Double-click the Lexmark Z45 Utility icon.
- 3 From the Cartridges tab, click Print Test Page to make sure the printer is functioning properly.
 - If a test page prints, the printer is working properly. Check the documentation for the software application you used to create your document.
 - If the test page does not print, see **Test page does not print**.

Printer overview

Basic printing

Printing ideas

Maintenance

Troubleshooting

Notices

Index

Using this
Guide...

Solving printer software installation problems

If the printer software does not install properly, a communications error message appears when you try to print. You may need to uninstall the printer software, and then reinstall it.

Uninstalling the printer software

- 1 Insert the printer software CD.
The Lexmark Installer screen appears.
- 2 Double-click the CD icon.
- 3 Double-click Install OS X.
- 4 Click Uninstall.
- 5 Follow the steps on your screen to uninstall the printer software.
- 6 Continue with **Installing the printer software**.

Note: If the installer did not automatically launch, double-click the Install icon to launch the installer.



Printer overview

Basic printing

Printing ideas

Maintenance

Troubleshooting

Notices

Index

Using this
Guide...

Installing the printer software

You can install the printer software using the CD that came with your printer, or you can download it from the Lexmark Web site at www.lexmark.com.

To connect your printer to a network with a Lexmark adapter, refer to the documentation that came with your adapter.

Using the CD that came with your printer

- 1 Close all open software applications.
- 2 When your desktop appears, insert the printer software CD.
- 3 Double-click Lexmark Z45 CD.
- 4 Double-click Install OS X.
- 5 Click Install and Agree.

Note: If the Printer Selection or the New Network Printer Found dialog box appears, follow the instructions displayed. Click the ? on the screen or contact your network administrator for help.

- 6 Choose the country or region closest to you if your country is not listed.
- 7 Click Continue.

Printer overview

Basic printing

Printing ideas

Maintenance

Troubleshooting

Notices

Index

Using this
Guide...

- 8 Follow the instructions on your screen to complete printer software installation.
- 9 On the Printer Selection screen, click Open Print Center.

Note: The Lexmark Z45 should appear in the Print Center as added automatically. If it does not, click Add Printer.

- 10 Click the red close button to close the Print Center.
- 11 On the Printer Selection screen, click Continue.
- 12 Click Continue to print an alignment page, used to automatically align the cartridges.
 - If the alignment page does not print, make sure you installed the cartridges correctly. For help, see **Installing a cartridge**.
 - If the paper is jammed, make sure you follow the instructions on the error message that is displayed. For help, see **Clearing paper misfeeds or jams**.

Using the World Wide Web

- 1 Make sure Stuffit Expander is loaded on your system.
- 2 From the Lexmark Web site, www.lexmark.com, select the appropriate driver for your operating system.
- 3 Click the binhex (.hqx) file to download and install.



Printer overview

Basic printing

Printing ideas

Maintenance

Troubleshooting

Notices

Index

Using this
Guide...

- 4 Use Stuffit Expander to expand the file on your desktop.
- 5 Double-click the folder to open it.
- 6 Double-click Install.
- 7 Follow the instructions on your screen to install the printer software.



Printer overview

Basic printing

Printing ideas

Maintenance

Troubleshooting

Notices

Index

Using this
Guide...

Solving network printing problems

For help, first see [Solving general printing problems](#).

If one or more of the following conditions applies to your network printer, you must enter an IP address to set up your network printer:

- Your printer is listed as unconfigured in the Network Printer Configuration Dialog or in the Printer Selection dialog.
- Your printer is on a remote subnet.

If one or more of the conditions above applies to your network printer, continue with [Entering an IP address](#). If none of these conditions apply, continue with [Troubleshooting your network printer](#).

Printer overview

Basic printing

Printing ideas

Maintenance

Troubleshooting

Notices

Index

Using this
Guide...

Entering an IP address

To enter an IP address and set up your network printer:

- 1 Open the **Lexmark Z45 Utility**.
- 2 From the Advanced menu, choose Network Printer Configuration.
- 3 From the dialog:

Click:	To:
A printer from the list of available network printers, and then click Configure...	Enter an available IP address for the selected printer. For help selecting an IP address, refer to the documentation you used to set up your network or contact your network administrator.
Add Remote...	Expand the printer list to include printers on a remote subnet. <ul style="list-style-type: none"> • If you choose Add Single Printer, enter the IP address for the printer you want to add. • If you choose Search Subnet, enter the IP address of the subnet you want to scan. Any remote printers that are found will be added to the printer list. These printers are saved in the list if a printer is added in Print Center.

The IP address of your network printer is set.

- 4 Click Done.



Printer overview

Basic printing

Printing ideas

Maintenance

Troubleshooting

Notices

Index

Using this
Guide...

- 5 Click the red close button to close the Lexmark Z45 Utility.

Troubleshooting your network printer

Try these solutions when you cannot print to your network printer:

- 1 Make sure your printer is connected to a working network connection.
- 2 If you are using a Lexmark adapter, make sure all of the indicator lights are on. For help locating these lights, refer to the adapter documentation.
- 3 Make sure the printer software is installed correctly:
 - a From a Finder window, click Computer ▶ OS X icon ▶ Library ▶ Printers ▶ Lexmark.
 - b If a Lexmark Z45 Utility for your printer does not appear, install the printer software. For help, see **Installing the printer software**.
- 4 Try **Printing a test page**.

If the test page does not print, see **Test page does not print**.

Printer overviewBasic printingPrinting ideasMaintenanceTroubleshootingNoticesIndexUsing this
Guide...

Understanding error messages and flashing lights

Use this section to understand printer software error messages on your computer screen and blinking lights on your printer. For information about lights on a Lexmark adapter, refer to the adapter documentation.

Paper Jam message

For help clearing a paper jam, see [Clearing paper misfeeds or jams](#).

Ink Low message

A print cartridge is running out of ink. To order a new cartridge or locate a dealer near you, contact the Lexmark Web site at www.lexmark.com. For help installing the cartridge, see [Replacing the print cartridge](#).

Printer overview

Basic printing

Printing ideas

Maintenance

Troubleshooting

Notices

Index

Using this
Guide...

Paper feed light is blinking

If the printer is out of paper:

- 1 Load paper. For help, see [Load the paper](#).
- 2 Press the paper feed button.

If the printer has a paper jam, see [Clearing paper misfeeds or jams](#).

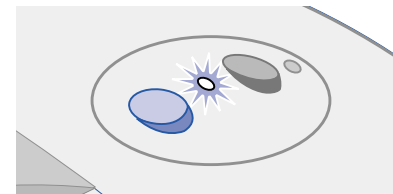

Power light is flashing

The print cartridge carrier is stalled.

- 1 Check your computer screen for error messages.
- 2 Turn the printer off.
- 3 Wait a few seconds, and then turn the printer back on. For more help, see [Clearing paper misfeeds or jams](#).



Printer overview

Basic printing

Printing ideas

Maintenance

Troubleshooting

Notices

Index

Using this
Guide...

Resolving unsuccessful or slow printing

For help, first see [Solving general printing problems](#).

If there is still a problem, click the topic that best describes it:

- **Printer is plugged in, but does not print**
- **Printer ejects a blank page after appearing to print**
- **Test page does not print**
- **Printer prints very slowly**



Printer overview

Basic printing

Printing ideas

Maintenance

Troubleshooting

Notices

Index

Using this
Guide...

Printer is plugged in, but does not print

Make sure:

- The printer is on and the printer cable is securely attached at both ends. If your printer is connected to a network, make sure the Lexmark adapter is on and all indicator lights are on. For help, refer to the adapter documentation.
- The paper is loaded correctly and not pushed too far into the printer. For help, see **Basic printing**. If the paper is jammed, see **Clearing paper misfeeds or jams**.
- The printer is not being held or paused. To check the printer status:
 - a** From the Finder, click the Applications icon.
 - b** From the Applications folder, double-click the Utilities icon, and then double-click the Print Center.
 - c** If necessary, click View Printer List.
 - d** Highlight the Lexmark Z45 in the list.
 - e** From Queue menu, choose Start Queue, if available.
 - f** From the Printers menu, choose Show Queue.
 - g** Select your job from the list.
 - h** Click Resume or Retry.

Printer overview

Basic printing

Printing ideas

Maintenance

Troubleshooting

Notices

Index

Using this
Guide...

- The printer is set as the default printer. To set the printer as the default:
 - a From the Finder, click the Applications icon.
 - b From the Applications folder, double-click the Utilities icon, and then double-click the Print Center.
 - c If necessary, click View Printer List.
 - d Highlight the Lexmark Z45 in the list.
 - e From the Printers menu, choose Make Default.

After you check these items, try **Printing a test page**.

If the test page prints, the printer is functioning properly. If it does not print, see **Test page does not print**.

Printer overview

Basic printing

Printing ideas

Maintenance

Troubleshooting

Notices

Index

Using this
Guide...

Test page does not print

For help, first see [Solving general printing problems](#), then:

- If the paper is jammed, see [Clearing paper misfeeds or jams](#).
- Make sure the printer is not being held or paused. To check the printer status:
 - a From the Finder, click the Applications icon.
 - b From the Applications folder, double-click the Utilities icon, and then double-click the Print Center.
 - c If necessary, click View Printer List.
 - d Highlight the Lexmark Z45 in the list.
 - e From the Queue menu, choose Start Queue, if available.
 - f From the Printers menu, choose Show Queue.
 - g Select your job from the list.
 - h Click Resume or Retry.

Printer overview

Basic printing

Printing ideas

Maintenance

Troubleshooting

Notices

Index

Using this
Guide...

- i Try printing your test page again. If it still does not print, see:
 - **Resolving unsuccessful or slow printing**
 - **Solving printer software installation problems**
 - **Solving network printing problems**

Printer ejects a blank page after appearing to print

Make sure:

- You remove the sticker and transparent tape from the back and bottom of the print cartridges. For help, see **Replacing the print cartridge**.
- Your cartridge does not have clogged nozzles. Try **Cleaning the print cartridge nozzles**.

Printer overview

Basic printing

Printing ideas

Maintenance

Troubleshooting

Notices

Index

Using this
Guide...

Printer prints very slowly

- If you are using a Mac OS X version prior to 10.1, consider upgrading to enhance print system performance.
- Close any software applications not in use.
- Check the document you are printing. Photos and graphics may take longer to print than regular text. Documents that are large or that contain background images may also take longer to print.
- Check the printer to see if another document is being printed. Print jobs are printed in the order the printer receives them. If other documents were sent to the printer before yours, your document is delayed until the other documents print.
- Decrease the print quality setting to Normal or Quick Print.

Note: Higher print quality settings result in better quality documents, but may take longer to print.



Printer overview

Basic printing

Printing ideas

Maintenance

Troubleshooting

Notices

Index

Using this
Guide...

Clearing paper misfeeds or jams

Click the topic that best describes your problem:

- **Paper misfeeds or multiple sheets feed**
- **Printer does not feed envelopes or specialty paper**
- **Printer has a paper jam**



Printer overview

Basic printing

Printing ideas

Maintenance

Troubleshooting

Notices

Index

Using this
Guide...

Paper misfeeds or multiple sheets feed

Make sure:

- The edges of your paper are not curled.
- Your paper is recommended for inkjet printers.
- A piece of paper from a previous print job is not jammed in the printer.
- You do not load too much paper. Depending on the weight of the paper, you can load up to 100 sheets of plain paper.
- You do not force the paper too far into the printer.
- The paper guide is against the left edge of the paper.
- The paper guide does not cause the paper to bow.
- The printer is on a flat, level surface.
- The printer settings you have chosen are correct for the type of document you are printing. For help, see **Basic printing** or **Printing ideas**.

Printer overview

Basic printing

Printing ideas

Maintenance

Troubleshooting

Notices

Index

Using this
Guide...

Printer does not feed envelopes or specialty paper

Make sure:

- Your printer feeds paper without problems. Load the envelopes or specialty paper vertically against the right side of the paper support. Squeeze and slide the paper guide to the left edge of the envelopes or specialty paper. For help, see **Printing ideas**.
- You select the appropriate envelope or specialty paper size in the **Page Setup dialog** and the appropriate paper type in the **Print dialog**.
- You are using a specialty paper or envelope size supported by your printer.
- Your software application is designed to print envelopes. For help, check your software application documentation.
- The envelope or specialty paper is not jammed. For help, see **Printer has a paper jam**.
- Your printer is not being held or paused. To check the printer status:
 - a From the Finder, click the Applications icon.
 - b From the Applications folder, double-click the Utilities icon, and then double-click the Print Center.
 - c If necessary, from the Printer menu, choose View Printer List.

Printer overview

Basic printing

Printing ideas

Maintenance

Troubleshooting

Notices

Index

Using this
Guide...

- d** Highlight the Lexmark Z45 in the list.
- e** From the Queue, choose Start Queue, if available.
- f** From the Printers menu, choose Show Queue.
- g** Select a job from the list.
- h** Click Resume or Retry.

Printer has a paper jam

If the paper is lodged too far into the printer and cannot be removed:

- 1** Turn the printer off.
- 2** Turn the printer back on.
- 3** If the printer does not automatically eject the page:
 - a** Turn the printer off.
 - b** Pull firmly on the paper to remove it.

If you cannot reach the paper, raise the front cover, pull the paper out, and then close the front cover.
 - c** Turn the printer on.

Printer overview

Basic printing

Printing ideas

Maintenance

Troubleshooting

Notices

Index

Using this
Guide...

Improving print quality

If print quality is unsatisfactory, you may need to adjust your margin settings, choose a higher print quality, align the print cartridges, or clean the nozzles.

Click one of the topics below for more information on how you can improve print quality:

- **Print is too dark or smudged**
- **Printed characters are improperly formed or misaligned**
- **Vertical straight lines are not smooth**
- **Colors on the printout differ from the colors on the screen**
- **Print smears on the page**
- **Colors on the printout are faded**
- **Printed pages have alternating bands of light and dark print (intermittent printing)**
- **Characters are missing or unexpected**
- **Print quality is poor at the edges**
- **Photos do not print as expected**

Printer overview

Basic printing

Printing ideas

Maintenance

Troubleshooting

Notices

Index

Using this
Guide...

Print is too dark or smudged

- Make sure the paper is straight and not wrinkled.
- Let the ink dry completely before handling the paper.
- Make sure the paper type and paper size settings in the printer software match the paper loaded in the printer. For help, see [Understanding the printer software](#).
- Change the print quality setting to Quick Print.
- Try [Cleaning the print cartridge nozzles](#).

Vertical straight lines are not smooth

To improve the print quality of vertical straight lines in tables, borders, and graphs:

- Select a higher print quality.
- Try [Aligning the print cartridges](#).
- Try [Cleaning the print cartridge nozzles](#).



Printer overview

Basic printing

Printing ideas

Maintenance

Troubleshooting

Notices

Index

Using this
Guide...

Print smears on the page

- The next page exiting the printer may be smearing the ink. Remove each page as it exits the printer and let it dry completely before stacking.
- Try **Cleaning the print cartridge nozzles**.

Printed pages have alternating bands of light and dark print (intermittent printing)

- From the Print Quality area, click Better or Best.
- If your printer is connected to your computer through a hub or peripheral device, such as a scanner or fax machine, connect the printer directly to your computer with a USB cable.
- If your printer is connected to your network, connect the printer directly to your computer with a USB cable.

Printer overview

Basic printing

Printing ideas

Maintenance

Troubleshooting

Notices

Index

Using this
Guide...

Print quality is poor at the edges

Like other printers, your printer cannot print on the extreme edges of a page.

Margin:	Minimum setting:
Left and right	<ul style="list-style-type: none">• 6.35 mm (0.25 in.) for U.S. Letter, U.S. Legal, Banner Letter, and custom paper sizes• 3.175 mm (0.125 in.) for envelopes• 3.37 mm (0.13 in.) for most paper sizes
Top	<ul style="list-style-type: none">• 1.7 mm (0.067 in.)
Bottom	<ul style="list-style-type: none">• 12.7 mm (0.5 in.) for black print jobs• 19 mm (0.75 in.) recommended for color print jobs



Printer overview

Basic printing

Printing ideas

Maintenance

Troubleshooting

Notices

Index

Using this
Guide...

Printed characters are improperly formed or misaligned

- Cancel all print jobs and print your job again. To cancel all print jobs:
 - a From the Finder, click the Applications icon.
 - b From the Applications folder, double-click the Utilities icon, and then double-click the Print Center.
 - c If necessary, click View Printer List.
 - d Highlight the Lexmark Z45 in the list.
 - e From the Queue menu, choose Start Queue.
 - f From the Printers menu, choose Show Queue.
 - g Select the job you want to delete.
 - h Click Delete.
 - i Repeat **step g** and **step h** until all jobs are deleted.
- Try **Aligning the print cartridges**.
- Try **Cleaning the print cartridge nozzles**.

Printer overview

Basic printing

Printing ideas

Maintenance

Troubleshooting

Notices

Index

Using this
Guide...

Colors on the printout differ from the colors on the screen

- A cartridge may be low on ink. For help, see [Replacing the print cartridge](#).
- Use a different paper brand. Each paper brand accepts ink differently and prints with color variations.

Select Natural Color as the document color:

- 1 From the software application File menu, choose Print.
- 2 From the Printer pop-up menu, select Lexmark Z45.
- 3 From the pop-up menu in the upper left, choose Color Options.
- 4 From the Document Color pop-up menu, choose Natural.

Colors on the printout are faded

Try the suggestions listed in the section [Colors on the printout differ from the colors on the screen](#). If the colors still seem faded, try [Cleaning the print cartridge nozzles](#).

Characters are missing or unexpected

Try [Cleaning the print cartridge nozzles](#).

Printer overview

Basic printing

Printing ideas

Maintenance

Troubleshooting

Notices

Index

Using this
Guide...

Photos do not print as expected

To improve the quality of printed photos:

- Select a higher print quality.
- Select photo paper as the paper type.



[Printer overview](#)[Basic printing](#)[Printing ideas](#)[Maintenance](#)[Troubleshooting](#)[Notices](#)[Index](#)[Using this Guide...](#)

Solving specialty paper problems

Use this section to help solve problems with specialty paper.

Glossy or photo papers or transparencies stick together

- Use a photo paper or transparency designed for an inkjet printer.
- Make sure you loaded the paper correctly (with print side facing you) and selected the appropriate settings in the printer software. For help, see [Printing photos](#) or [Printing transparencies](#).
- Remove each page as it exits the printer and let it dry completely before stacking.

Transparencies or photos contain white lines

- Make sure you loaded the paper correctly (with print side facing you) and selected the appropriate settings in the printer software. For help, see [Printing transparencies](#) or [Printing photos](#).
- Choose a higher print quality, such as Better or Best. For help, see [Basic printing](#).
- Try [Cleaning the print cartridge nozzles](#).

Printer overview

Basic printing

Printing ideas

Maintenance

Troubleshooting

Notices

Index

Using this
Guide...

Alignment page does not print

Make sure:

- You completely removed the transparent tape and sticker from the back and bottom of the print cartridges.
- You installed the cartridges correctly. For help, see [Installing a cartridge](#).
- You loaded the paper correctly and did not push the paper too far into the printer. For help, see [Basic printing](#).
- If you are connected to a network with a Lexmark adapter, the indicator lights are on. For more information, see the adapter documentation.



Printer overview

Basic printing

Printing ideas

Maintenance

Troubleshooting

Notices

Index

Using this
Guide...

This section contains information regarding legal notices.

- **Edition notice**
- **Trademarks**
- **Warning**



 Printer overview Basic printing Printing ideas Maintenance Troubleshooting Notices Index Using this Guide...

Edition notice

Edition: January 2002

The following paragraph does not apply to any country where such provisions are inconsistent with local law: LEXMARK INTERNATIONAL, INC., PROVIDES THIS PUBLICATION “AS IS” WITHOUT WARRANTY OF ANY KIND, EITHER EXPRESS OR IMPLIED, INCLUDING, BUT NOT LIMITED TO, THE IMPLIED WARRANTIES OF MERCHANTABILITY OR FITNESS FOR A PARTICULAR PURPOSE. Some states do not allow disclaimer of express or implied warranties in certain transactions; therefore, this statement may not apply to you.

This publication could include technical inaccuracies or typographical errors. Changes are periodically made to the information herein; these changes will be incorporated in later editions. Improvements or changes in the products or the programs described may be made at any time.

Comments about this publication may be addressed to Lexmark International, Inc., Department F95/032-2, 740 West New Circle Road, Lexington, Kentucky 40550, U.S.A. In the United Kingdom and Eire, send to Lexmark International Ltd., Marketing and Services Department, Westhorpe House, Westhorpe, Marlow, Bucks SL7 3RQ. Lexmark may use or distribute any of the information you supply in any way it believes appropriate without incurring any obligation to you. You can purchase additional copies of publications related to

Printer overviewBasic printingPrinting ideasMaintenanceTroubleshootingNoticesIndexUsing this
Guide...

this product by calling 1-800-553-9727. In the United Kingdom and Eire, call 0628-481500. In other countries, contact your point of purchase.

References in this publication to products, programs, or services do not imply that the manufacturer intends to make these available in all countries in which it operates. Any reference to a product, program, or service is not intended to state or imply that only that product, program, or service may be used. Any functionally equivalent product, program, or service that does not infringe any existing intellectual property right may be used instead. Evaluation and verification of operation in conjunction with other products, programs, or services, except those expressly designated by the manufacturer, are the user's responsibility.

© Copyright 2002 Lexmark International, Inc.
All rights reserved.

UNITED STATES GOVERNMENT RESTRICTED RIGHTS

This software and documentation are provided with RESTRICTED RIGHTS. Use, duplication, or disclosure by the Government is subject to restrictions as set forth in subparagraph (c)(1)(ii) of the Rights in Technical Data and Computer Software clause at DFARS 252.227-7013 and in applicable FAR provisions: Lexmark International, Inc., Lexington, KY 40550.



Printer overview



Basic printing



Printing ideas



Maintenance



Troubleshooting



Notices



Index

Using this
Guide...

Trademarks

Lexmark and Lexmark with diamond design are trademarks of Lexmark International, Inc., registered in the United States and/or other countries. Color Jetprinter is a trademark of Lexmark International, Inc.

Other trademarks are the property of their respective owners.



Printer overview

Basic printing

Printing ideas

Maintenance

Troubleshooting

Notices

Index

Using this
Guide...

Warning

Warning: A warning identifies something that might damage your printer hardware or software.



Printer overview

Basic printing

Printing ideas

Maintenance

Troubleshooting

Notices

Index

Using this
Guide...

A

aligning print cartridges 55
automatic cartridge
alignment 55

B

banding 87
banner paper 47
black cartridge part number 61
blinking lights 74
buttons
paper feed 15
power 15

C

cable, part numbers
USB 61
cards 27
cartridges, print
aligning 55
cleaning 57
installing 52
ordering 61
part numbers 61
preserving 60

removing 51
replacing 51
wiping 58
characters, misformed 89
cleaning, print cartridge
nozzles 57
coated paper 21
color cartridge part number 61
conserving color ink 33
contacts, wiping 58
customizing settings
banners 48
cards 28
coated paper 22
envelopes 31
foils 45
glossy paper 22
greeting cards 28
handouts 39
index cards 28
iron-on transfers 42
labels 36
n-up
See handouts
photo cards 28
photo paper 22
postcards 28

premium paper 25
printing color images in
black and white 34
transparencies 45
t-shirt transfers 42

D

dark or smudged print 86
downloaded printer driver,
installing 68

E

edition notice 95
envelopes 30
error messages
Ink Low 73
Paper Jam 73

F

flashing lights 73
foils
See transparencies

G

glossy paper 21

Printer overview

Basic printing

Printing ideas

Maintenance

Troubleshooting

Notices

Index

Using this
Guide...

greeting cards 27

H

handouts 38

I

improving print quality 85

index cards 27

Ink Low message 73

installing

print cartridges 52

printer software 67

intermittent printing 87

iron-on transfers 41

L

labels 35

Lexmark Utility 11

lights

paper feed 74

power 74

loading

banner paper 47

cards 27

coated paper 21

envelopes 30

foils 44

glossy paper 21

greeting cards 27

handouts 38

index cards 27

iron-on transfers 41

labels 35

photo cards 27

photo paper 21

plain paper 17

postcards 27

premium paper 24

transparencies 44

t-shirt transfers 41

M

manual cartridge alignment 55

margins, minimum settings 88

messages, error

Ink Low 73

Paper Jam 73

N

navigating *User's Guide* 2

network, setting up printer 70

notices

edition notice 95

trademarks 97

warning 98

nozzles, print

wiping 58

n-up printing

See handouts

O

ordering supplies 61

P

page settings, changing 4

Page Setup dialog 5

paper exit tray 15

paper feed button 15

paper feed light 15

paper guide 15

Paper Jam message 73

paper jam, clearing 84

paper loading 17

paper misfeeds 81

paper support 15

part numbers

black cartridge 61

color cartridge 61

Printer overview

Basic printing

Printing ideas

Maintenance

Troubleshooting

Notices

Index

Using this
Guide...

- photo cartridge 61
- power supply 61
- USB cable 61
- photo cards 27
- photo cartridge part number 61
- photo paper 21
- postcards 27
- power button 15
- power light 15
- power supply
 - connector 15
- premium paper 24
- print cartridge
 - aligning 55
 - cleaning 57
 - installing 52
 - ordering 61
 - part numbers 61
 - preserving 60
 - removing 51
 - replacing 51
 - wiping 58
- Print dialog 6
- print nozzles, wiping 58
- print quality, troubleshooting 85
- printer driver
 - installing 67
 - uninstalling 66
- printer overview 3
- printer parts 14
- printer settings
 - customizing 18
- printer settings, customizing 4
- printer software
 - installing 67
 - Lexmark Utility 11
 - overview 4
 - Page Setup dialog 5
 - Print dialog 6
 - understanding 4
 - uninstalling 66
- printer status 76
- printing
 - alignment page 55
 - banners 47
 - cards 27
 - color images in black and white 33
 - envelopes 30
 - foils 44
 - greeting cards 27
 - handouts 38
 - index cards 27
 - iron-on transfers 41
 - labels 35
 - multiple pages per sheet 38
 - n-up
 - See handouts on premium paper 24
 - photo cards 27
 - photos 21
 - test page 65
 - transparencies 44
 - t-shirt transfers 41
- printing problems
 - blank pages 79
 - error messages 73
 - flashing lights 73
 - general 63
 - network 70
 - paper feeding 81
 - paper jams 84
 - print quality 85
 - software 66
 - specialty paper 92
 - unsuccessful or slow
 - printing 75
- printing *User's Guide 2*



Printer overview

Basic printing

Printing ideas

Maintenance

Troubleshooting

Notices

Index

Using this
Guide...

R

removing print cartridges 51
replacing the print cartridge 51

S

searching *User's Guide* 2
setting recommendations
 banner paper 48
 cards 28
 coated paper 22
 color images in black and
 white 34
 envelopes 31
 foils 45
 glossy paper 22
 greeting cards 28
 handouts 39
 index cards 28
 iron-on transfers 42
 labels 36
 n-up
 See handouts
 photo cards 28
 photo paper 22
 postcards 28
 premium paper 25

print color images in black
 and white 34
transparencies 45
t-shirt transfers 42

software, printer
 installing 67
 Lexmark Utility 11
 understanding 4
 uninstalling 66
specialty paper
 solving problems with 92
supplies, ordering 61

T

test page
 does not print 78
 printing 65
trademarks 97
transfers, iron-on 41
transparencies 44
troubleshooting
 alignment page 93
 blank pages 79
 error messages 73
 flashing lights 73
 general printing

problems 63
improving print quality 85
margins 88
network printing 70
paper feeding 81
paper jams 84
paper misfeeds 81
print quality 85
printer not printing 75
printer software
 installation 66
software 66
specialty paper 92
unsuccessful or slow
 printing 75

U

uninstalling printer software 66
USB cable
 connector 15
 ordering 61
User's Guide
 navigating 2
 printing 2
 searching 2
Utility, Lexmark 11

Printer overview

Basic printing

Printing ideas

Maintenance

Troubleshooting

Notices

Index

W

warning 98

Using this
Guide...

