

# Lexmark™ C77x Quick Reference

## Loading paper and specialty media

### Loading 500-sheet trays

- 1 Remove the tray and place it on a flat, level surface.
- 2 Squeeze the front guide lever and slide the guide to the front of the tray.

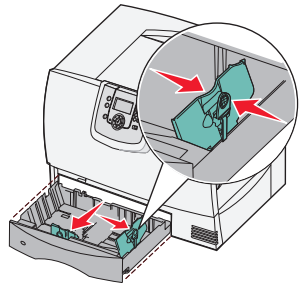

- 3 Squeeze the side guide lever and slide the guide to the correct position for the size paper you are loading. Icons along the back of the tray indicate paper sizes.
- 4 Flex the sheets back and forth to loosen them, and then fan them. Do not fold or crease the paper. Straighten the edges of the stack on a level surface.

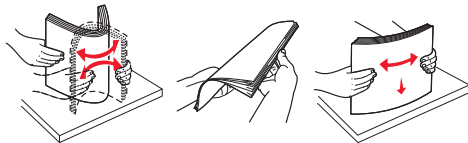

- 5 Place the paper in the tray as shown, print side down. Do not load bent or wrinkled paper.  
Maximum stack height indicator

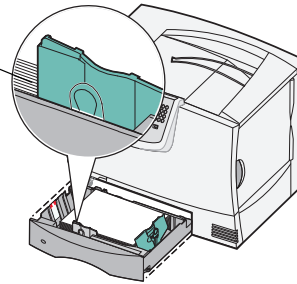

- 6 Squeeze the front guide lever and slide the guide until it firmly touches the stack of paper.

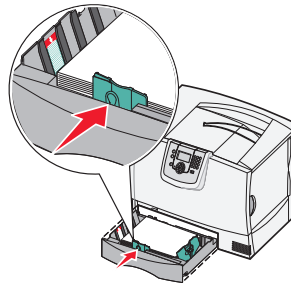

- 7 Reinstall the tray.
- 8 Make sure the tray is pushed completely into the printer.

### Loading the 2000-sheet tray

- 1 Pull open the tray.
- 2 Squeeze the side guide lever, lift the guide, and place it into the appropriate slot for the size paper you are loading.

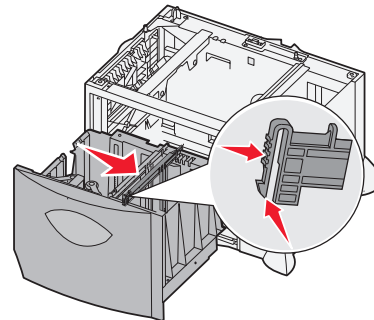

- 3 Squeeze the two front guide levers and slide the guide to the correct position for the size paper you are loading.

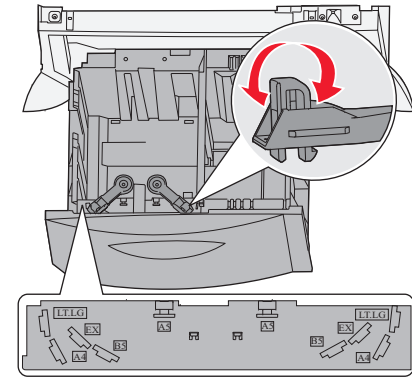

- 4 Slide the bottom support toward the front of the tray until it touches the front guide.

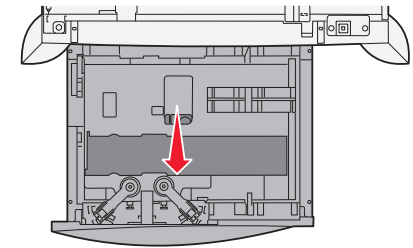

- 5 Flex the sheets back and forth to loosen them, and then fan them.

Do not fold or crease the paper. Straighten the edges of the stack on a level surface.

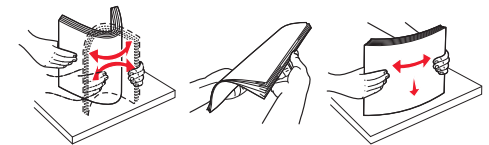

- 6 Place the paper against the back left corner of the tray, print side down.

Do not load bent or wrinkled print media.

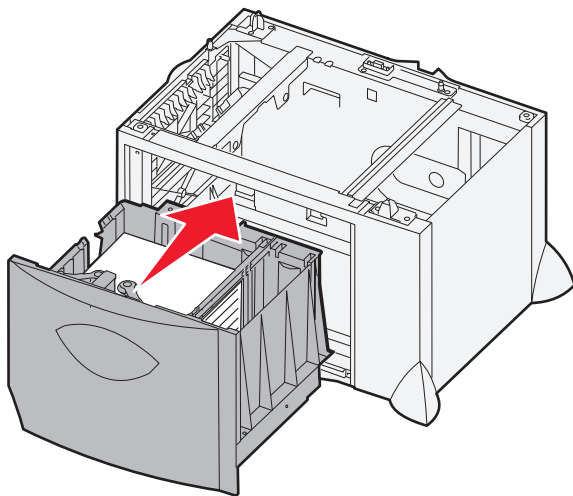

7 Close the tray.

Make sure the tray is pushed completely into the printer. Do not exceed the maximum stack height. Overfilling the tray may cause paper jams.

## Loading the multipurpose feeder

1 Open the multipurpose feeder.

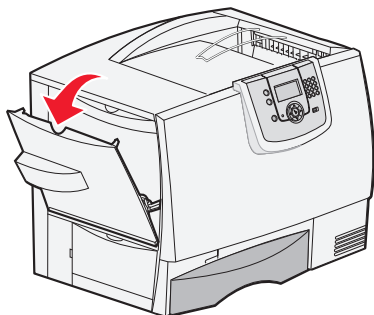

2 Squeeze the paper guide lever and slide the guide all the way toward the front of the printer.

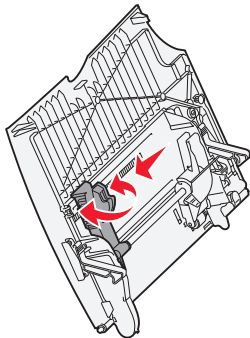

3 Flex the specialty media back and forth to loosen the stack, and then fan the stack. Do not fold or crease the media. Straighten the edges of the stack on a level surface.

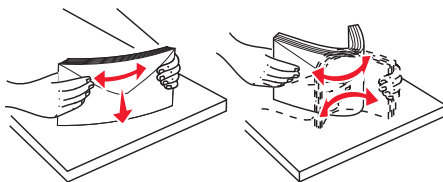

4 Arrange the stack of paper or specialty media correctly for the size, type, and print method you are using.

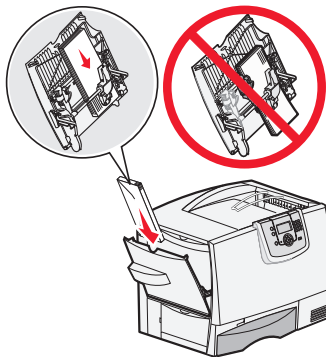

5 Place the paper or specialty media, print side up, along the left side of the multipurpose feeder, and then push it in as far as it will easily go.

Do not force the media.





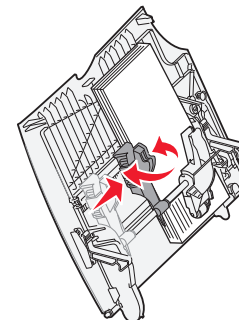













**Note:** Do not exceed the maximum stack height. Overfilling the feeder may cause jams.

6 Squeeze the paper guide lever and slide the guide until it lightly touches the side of the stack.



7 If you are loading a different type of media than was previously loaded in the tray, change the Paper Type setting for that tray on the operator panel.

## Setting the paper type and paper size

- 1 Press  on the operator panel.
- 2 Press  until you see  Paper Menu.
- 3 Press .
- 4 Press  until you see  Paper Size/Type.
- 5 Press .
- 6 Press  until you see  MP Feeder Size/Type.
- 7 Press .
- 8 Press  until the  appears next to the media size you loaded.
- 9 Press .
- 10 Press  until you see  MP Feeder Size/Type.
- 11 Press .
- 12 Press  until  appears next to the media type you loaded.
- 13 Press .

# Printing

## Printing a document

- 1 Open the file you want to print.
- 2 From the File menu, select **Print**.
- 3 Verify that the correct printer is selected in the dialog box.
- 4 Modify the printer settings as appropriate (such as the pages you want to print or the number of copies).

**Note:** Click **Properties** or **Setup** to adjust printer settings not available from the first screen, and click **OK**.

- 5 Click **OK** or **Print** to send the job to the selected printer.

## Printing confidential and other held jobs

- 1 With a document open, click **File** → **Print**.
- 2 Click **Properties**, **Preferences**, **Options**, or **Setup**.
- 3 Click **Other Options**, and then click **Print and Hold**.
- 4 Select your job type (Confidential, Reserve, Repeat, or Verify), and then assign a user name. For a confidential job, also enter a four-digit PIN.
- 5 Click **OK** or **Print**, and then go to the printer to release the job.
- 6 Press ▼ until ✓ **Held jobs** appears, and then press ✓.
- 7 Press ▼ until ✓ **Confidential jobs** appears, and then press ✓.
- 8 Press ▼ until the ✓ appears next to your user name, and then press ✓.
- 9 Enter your PIN.
- 10 Press ▼ until ✓ appears next to the job you want to print, and then press ✓.

After your job prints, it is deleted from printer memory.

## Printing from a USB flash memory device

A USB Direct interface is located on the operator panel so you can insert a USB flash memory device and print PDF documents and supported graphic files. Printing a document from a USB flash memory device is similar to printing a held job.

**Note:** Supported graphic types are .gif, .jpeg, .jpg, .bmp, .png, .tiff, .tif, .pcx, and .dcx.

For information regarding tested and approved USB flash memory devices, see the Lexmark Web site at [www.lexmark.com](http://www.lexmark.com).

- 1 Make sure the printer is on and **Ready** or **Busy** appears.
- 2 Insert a USB flash memory device into the USB Direct interface.

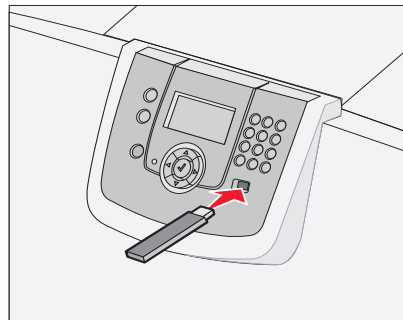

- 3 Press ▼ until ✓ appears next to the document you want to print, and then press ✓.  
A screen asking the number of copies to be printed will appear.
- 4 To print only one copy, press ✓, or manually input the number of copies with the number pad, then press ✓.

**Note:** Do not remove the USB flash memory device from the USB Direct

interface until the document has finished printing.

## Canceling a print job

If the job you want to cancel is printing, and **Busy** appears on the display, press ▼ until ✓ **Cancel a job** appears, and then press ✓. The message **Cancel Pending** appears until the job is canceled.

## Clearing jams

### Understanding jam messages

Message	What to do
200 Paper Jam	Clear <b>Area B</b> and <b>Area T1</b> .
201 Paper Jam	Clear <b>Area D</b> , <b>Area K</b> , and <b>Area L</b> .
202 Paper Jam	Clear <b>Area K</b> and <b>Area L</b> .
230 Paper Jam	Clear <b>Area E</b> and <b>Area J</b> .
24<x> Paper Jam	Clear <b>Area B</b> , <b>Area C</b> , and <b>Area T&lt;x&gt;</b> .
250 Paper Jam	Clear <b>Area A</b> and <b>Area D</b> .

### Area A

- 1 Release the levers on each side of the multipurpose feeder to lay it flat.

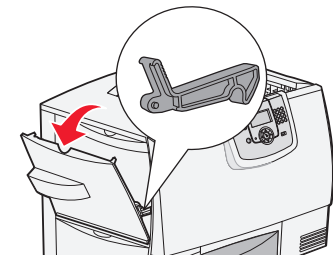

- 2 Press the pick assembly release lever, and remove all media and jams.

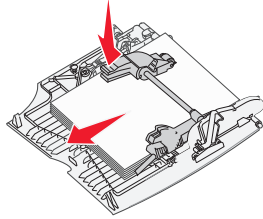

- 3 Return the feeder to its working position, and reload your paper.

## Area B

- 1 Open the left access door until it clicks into place.

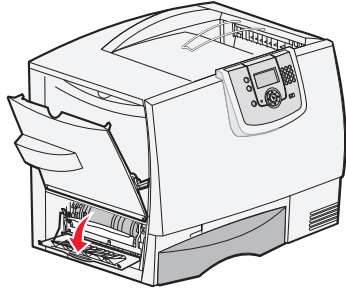

- 2 Remove all visible paper. Remove any torn paper from the printer.
- 3 Close the door.
- 4 Open Tray 1, and make sure the entire paper stack is pushed all the way down into the tray.

## Area C

- 1 Open the 500-sheet drawer access door. Hold the door down while removing jams.

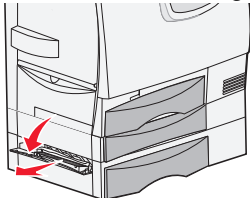

- 2 Make sure the entire paper stack is loaded correctly, and then close the door.

## Area D

- 1 Open the front access door.
- 2 Hold down the front access door. Remove jams in the rollers under the image transfer unit.

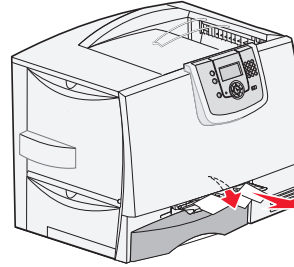

## Area T1

- 1 Open tray 1.
- 2 Remove any jams.
- 3 Make sure the paper is pushed all the way down into the tray, and then close tray 1.

## Area E

- 1 Pull the duplex tray E completely out. Remove any paper caught in the rollers or inside the printer.

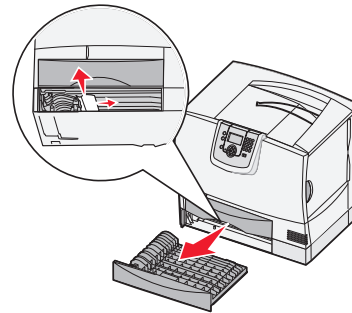

- 2 Reinstall the duplex mechanism in the printer.

## Area T<x>

- 1 Carefully open trays 2 through 4 (all 500-sheet trays), and then remove jams.
- 2 Make sure the paper is pushed all the way down into the tray, and then close trays 2 through 4.

## Area J

- 1 Remove the duplex tray J.

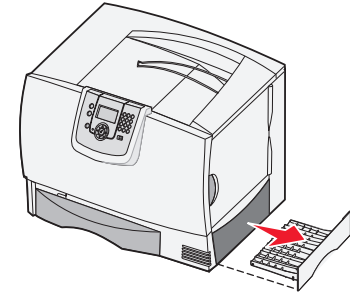

- 2 Remove any jams, and then reinstall the tray.

## Area K

- 1 Open the lower right access door.

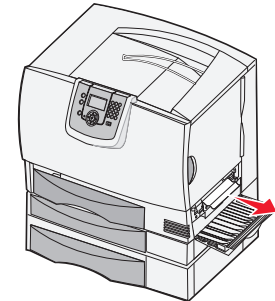

- 2 Remove any jams, and then close the door.

## Area L

- 1 Open the upper right access door.

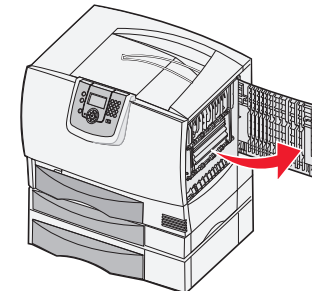

- 2 Remove jams from the rollers, and then close the door.