

Printing Guide

Loading the 250- or 550-sheet tray

 **CAUTION—POTENTIAL INJURY:** To reduce the risk of equipment instability, load each tray separately. Keep all other trays closed until needed.

1 Pull out the tray.

Notes:

- When loading folio-, legal-, or Oficio-size paper, lift the tray slightly and pull it out completely.
- Do not remove trays while a job prints or while **Busy** appears on the display. Doing so may cause a jam.

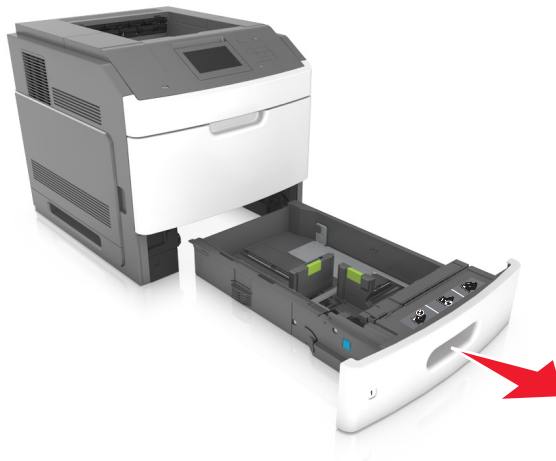

2 Squeeze and slide the width guide to the correct position for the size of the paper being loaded until it *clicks* into place.

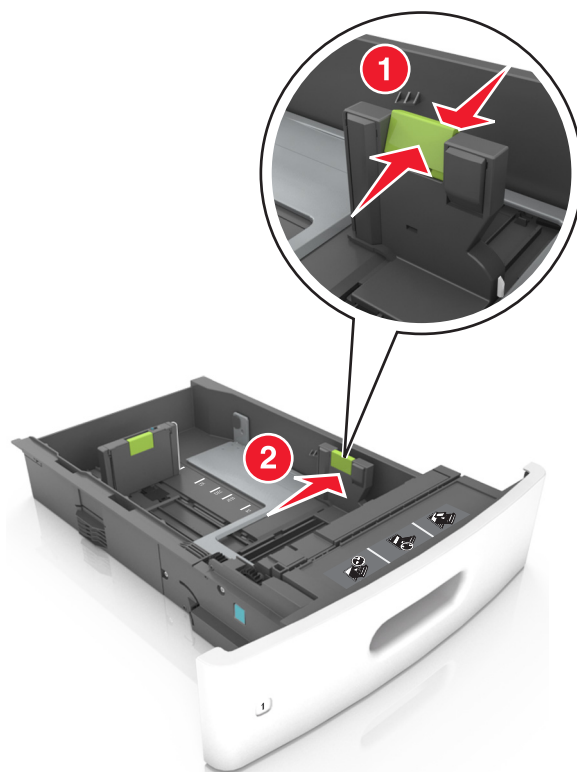

Note: Use the paper size indicators at the bottom of the tray to help position the guides.

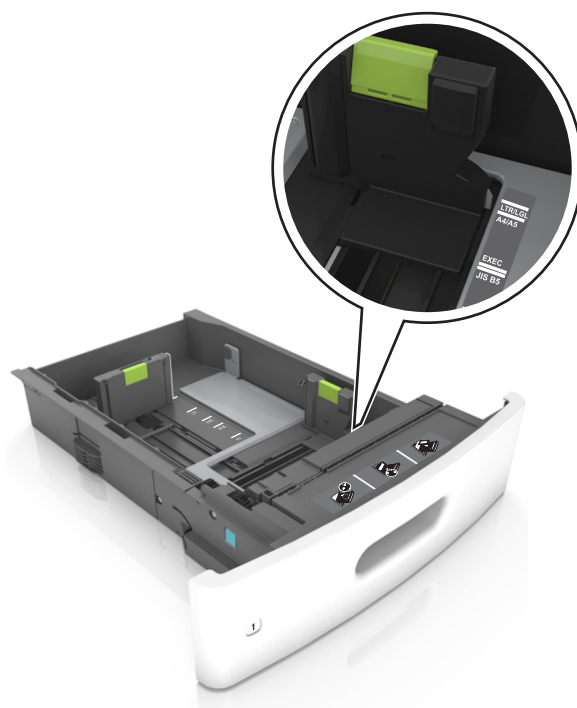

3 Unlock the length guide, and then squeeze and slide the guide to the correct position for the size of the paper being loaded.

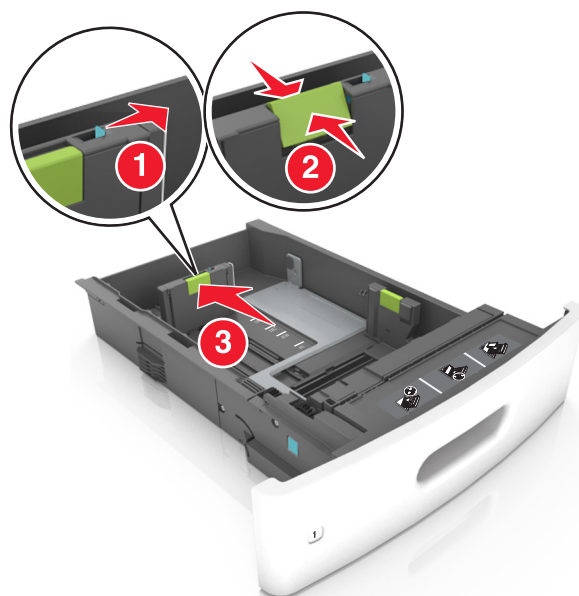

Notes:

- Lock the length guide for all paper sizes.
- Use the paper size indicators at the bottom of the tray to help position the guides.

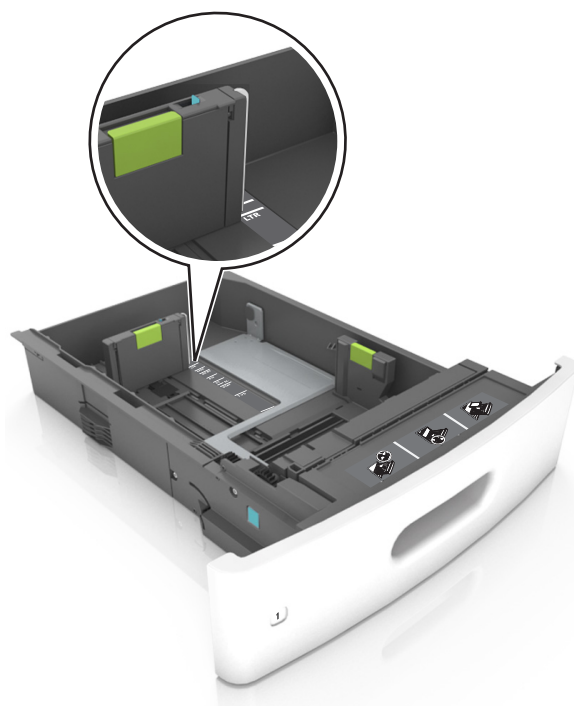



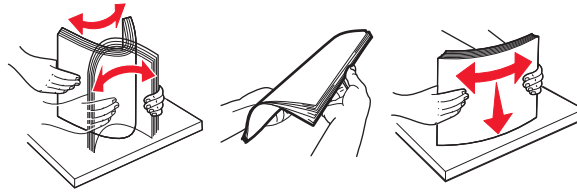

- 4 Flex the sheets back and forth to loosen them, and then fan them. Do not fold or crease the paper. Straighten the edges on a level surface.





- 5 Load the paper stack with the printable side facedown.

Note: Make sure the paper or envelope is loaded properly.

- There are different ways of loading letterhead depending on whether an optional staple finisher is installed or not.

Without an optional staple finisher	With an optional staple finisher
 <p>One-sided printing</p>	 <p>One-sided printing</p>
 <p>Two-sided printing</p>	 <p>Two-sided printing</p>

- If you are loading prepunched paper for use with the staple finisher, then make sure the holes on the long edge of the paper are on the right side of the tray.

One-sided printing	Two-sided printing
	

Note: If the holes on the long edge of the paper are on the left side of the tray, then a jam may occur.

- Do not slide the paper into the tray. Load paper as shown in the illustration.



- If you are loading envelopes, then make sure that the flap side is facing up and the envelopes are on the left side of the tray.

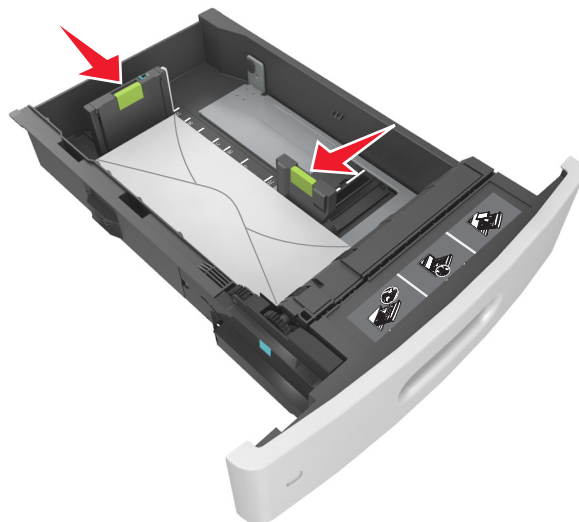

- Make sure the paper is below the solid line, which is the maximum paper fill indicator.



Warning—Potential Damage: Overfilling the tray can cause paper jams.

- When using card stock, labels, or other types of specialty media, make sure the paper is below the dashed line, which is the alternate paper fill indicator.

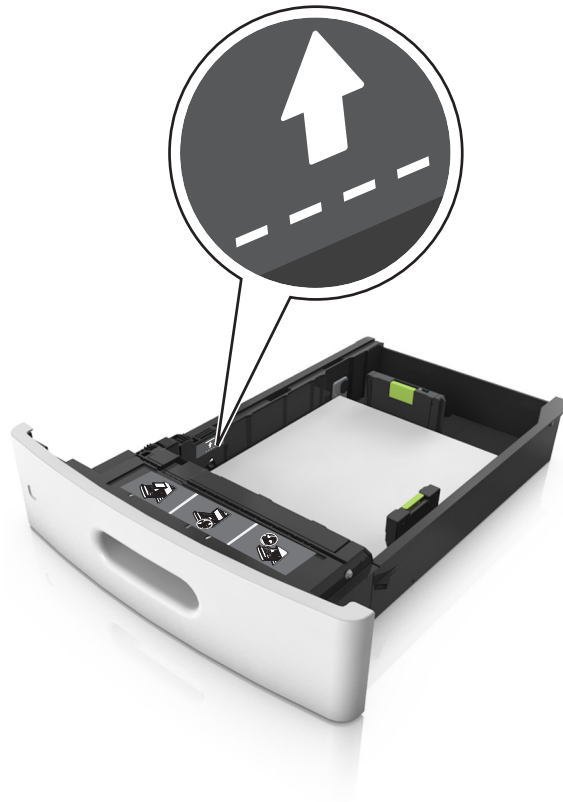

6 For custom- or Universal-size paper, adjust the paper guides to lightly touch the sides of the stack, and then lock the length guide.

7 Insert the tray.



8 From the printer control panel, set the paper size and paper type in the Paper menu to match the paper loaded in the tray.

Note: Set the correct paper size and type to avoid paper jams and print quality problems.

Loading the 2100-sheet tray

⚠ CAUTION—POTENTIAL INJURY: To reduce the risk of equipment instability, load each tray separately. Keep all other trays closed until needed.

- 1 Pull out the tray.
- 2 Adjust the width and length guides.

Loading A5-size paper

- a Pull up and slide the width guide to the position for A5.



b Squeeze and slide the length guide to the position for A5 until it *clicks* into place.

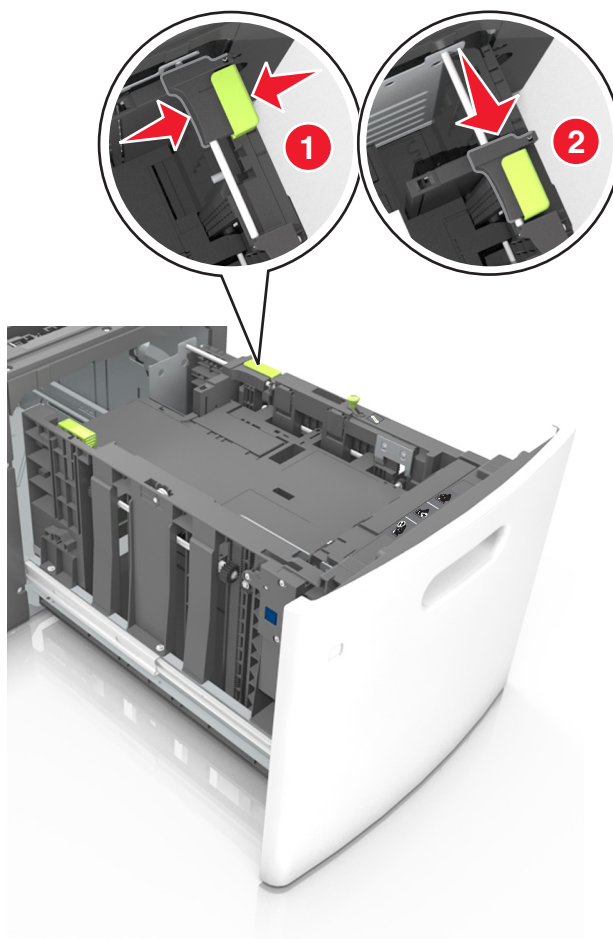

c Remove the A5 length guide from its holder.

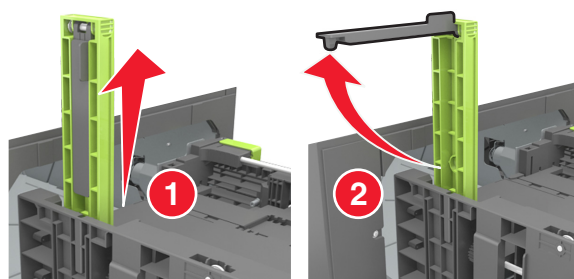

d Insert the A5 length guide into its designated slot.

Note: Press the A5 length guide until it *clicks* into place.

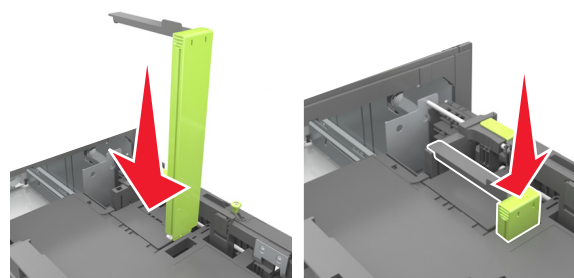

Loading A4-, letter-, legal-, Oficio-, and Folio-size paper

- a Pull up and slide the width guide to the correct position for the size of the paper being loaded.

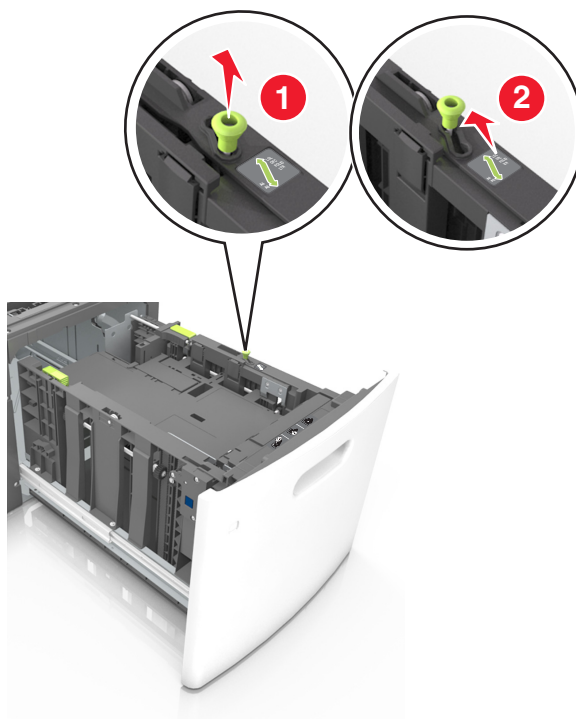

- b If the A5 length guide is still attached to the length guide, then remove it from its place. If the A5 length guide is not attached, then proceed to step d.

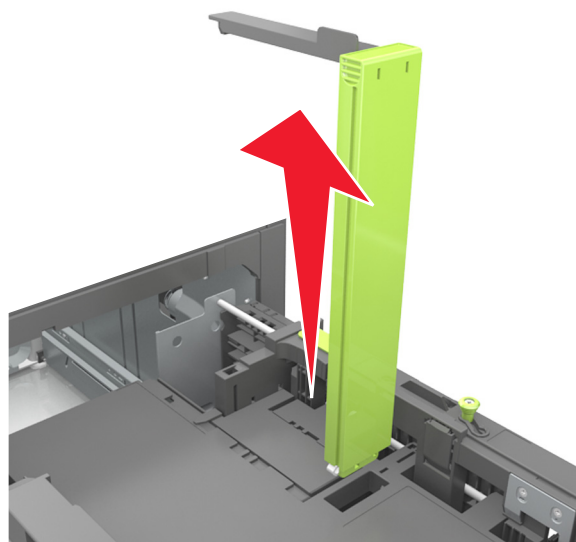

c Put the A5 length guide in its holder.

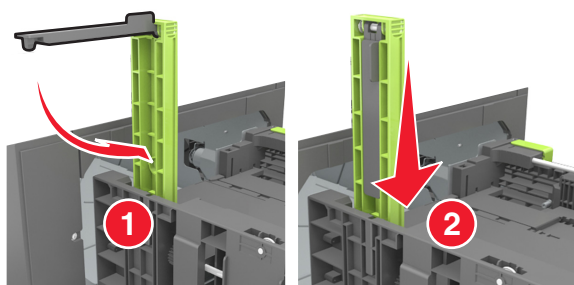

d Squeeze the length guide and slide it to the correct position for the size of the paper being loaded until it *clicks* into place.

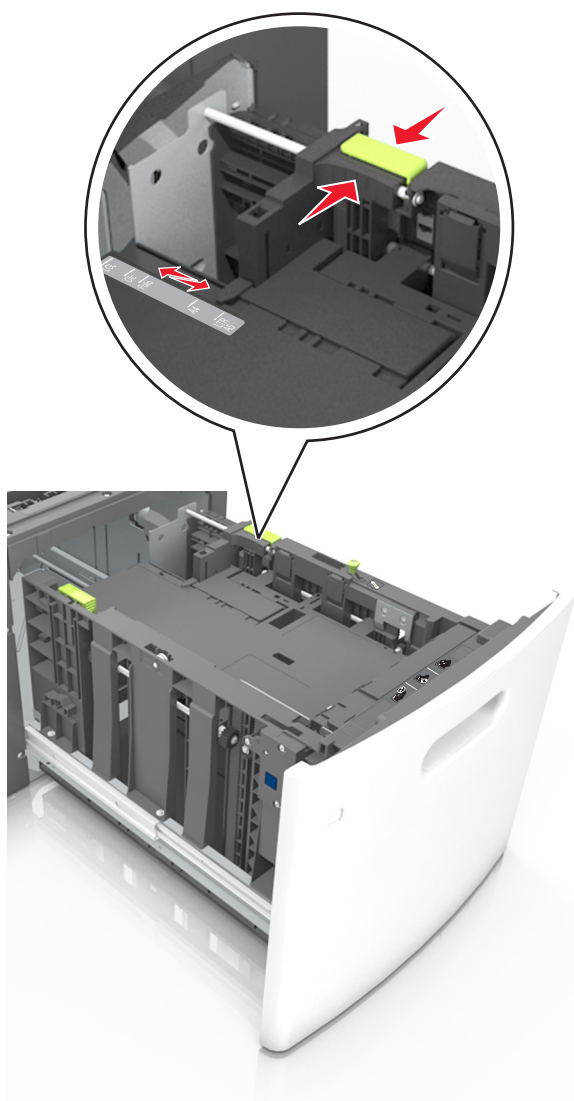



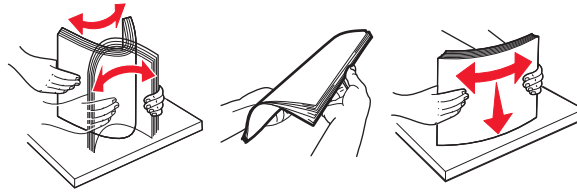

- 3 Flex sheets of paper back and forth to loosen them, and then fan them. Do not fold or crease the paper. Straighten the edges on a level surface.





- 4 Load the paper stack with the printable side facedown.

Note: Make sure the paper is loaded properly.

- There are different ways of loading letterhead depending on whether an optional staple finisher is installed or not.

Without an optional staple finisher	With an optional staple finisher
 <p>One-sided printing</p>	 <p>One-sided printing</p>
 <p>Two-sided printing</p>	 <p>Two-sided printing</p>

- If you are loading prepunched paper for use with the staple finisher, then make sure the holes on the long edge of the paper are on the right side of the tray.

One-sided printing	Two-sided printing
	

Note: If the holes on the long edge of the paper are on the left side of the tray, then a jam may occur.

- Make sure the paper is below the maximum paper fill indicator.

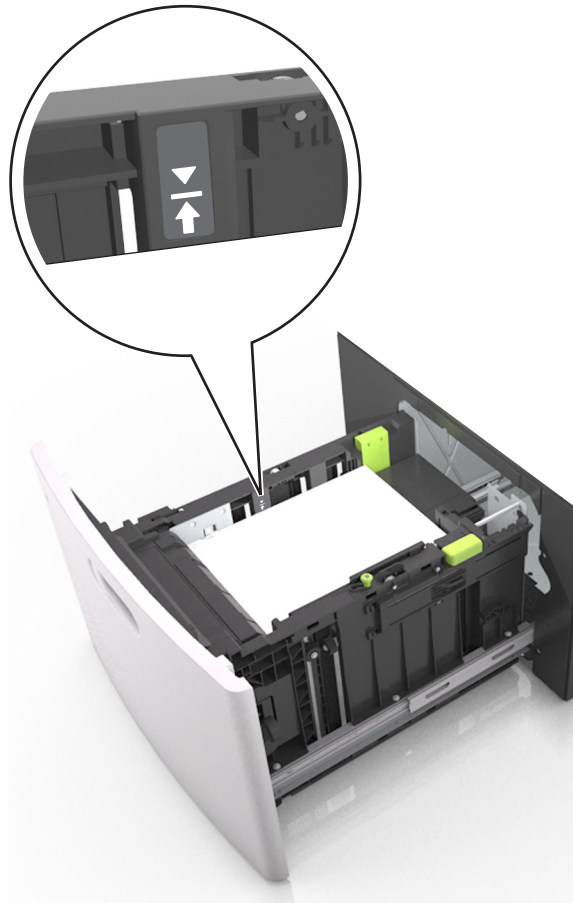

Warning—Potential Damage: Overfilling the tray can cause paper jams.

- 5 Insert the tray.

Note: Press the paper stack down while inserting the tray.

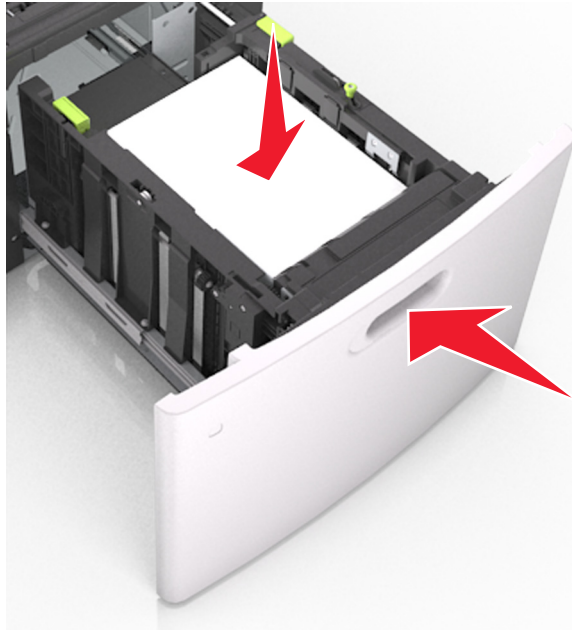

6 From the printer control panel, set the paper size and type in the Paper menu to match the paper loaded in the tray.

Note: Set the correct paper size and type to avoid paper jams and print quality problems.

Loading the multipurpose feeder

1 Pull down the multipurpose feeder door.

Note: Do not load or close the multipurpose feeder while a job is printing.



- 2 Pull the multipurpose feeder extender.

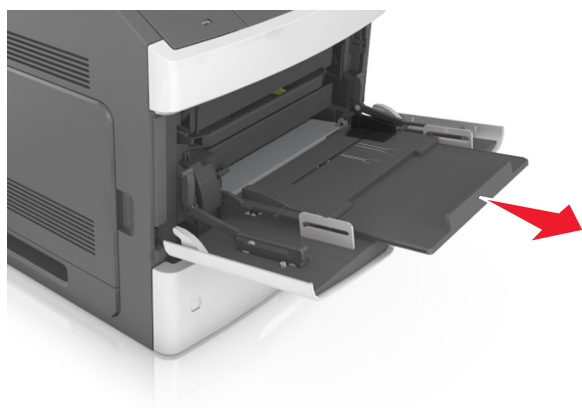

Note: Guide the extender gently so that the multipurpose feeder is fully extended and open.

- 3 Slide the width guide to the correct position for the size of the paper being loaded.

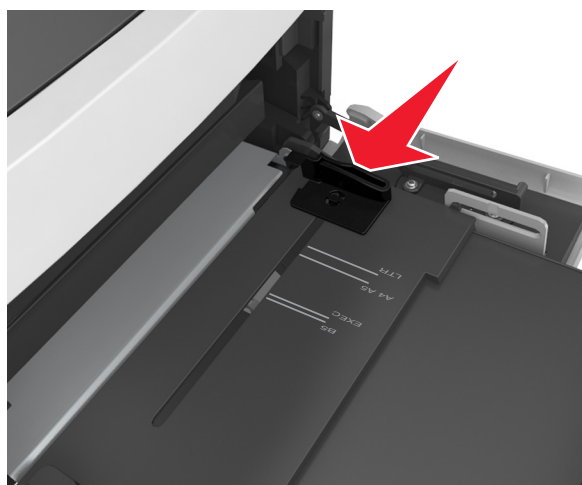

Note: Use the paper size indicators on the bottom of tray to help position the guides.

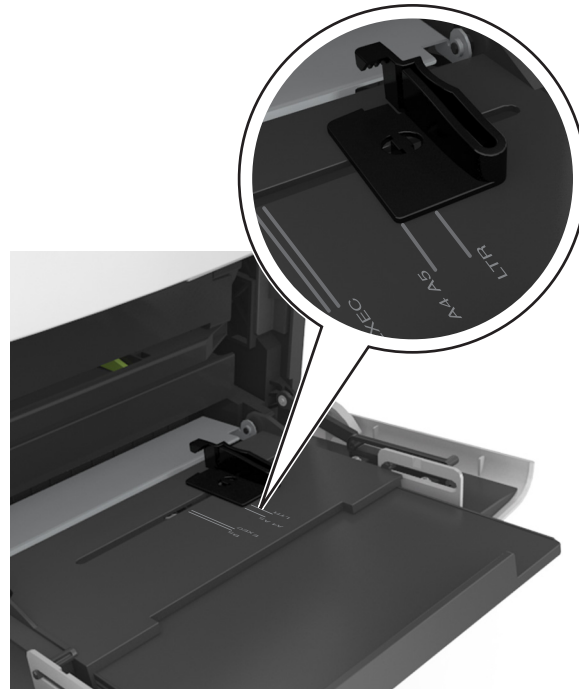

4 Prepare the paper or specialty media for loading.

- Flex sheets of paper back and forth to loosen them, and then fan them. Do not fold or crease the paper. Straighten the edges on a level surface.

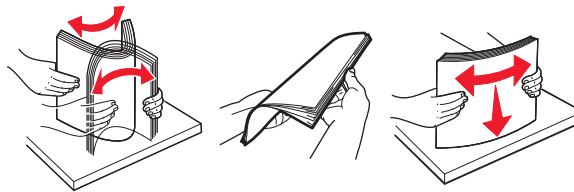

- Hold transparencies by the edges, and then fan them. Straighten the edges on a level surface.

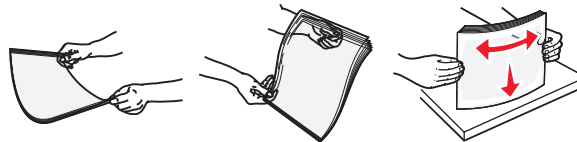

Note: Avoid touching the printable side of the transparencies. Be careful not to scratch them.





- Flex the stack of envelopes back and forth to loosen them, and then fan them. Straighten the edges on a level surface.





5 Load the paper or specialty media.

Note: Slide the stack gently into the multipurpose feeder until it comes to a stop.

- Load only one size and type of paper or specialty media at a time.
- Make sure the paper fits loosely in the multipurpose feeder, lies flat, and is not bent or wrinkled.
- There are different ways of loading letterhead depending on whether an optional staple finisher is installed or not.

Without an optional staple finisher	With an optional staple finisher
 <p data-bbox="565 590 773 621">One-sided printing</p>	 <p data-bbox="950 590 1157 621">One-sided printing</p>
 <p data-bbox="565 963 773 995">Two-sided printing</p>	 <p data-bbox="950 957 1157 989">Two-sided printing</p>

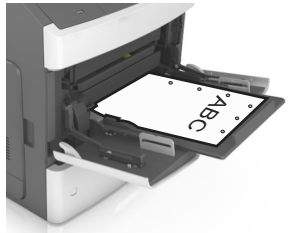
- If you are loading prepunched paper for use with the staple finisher, then make sure the holes on the long edge of the paper are on the right side of the tray.

One-sided printing	Two-sided printing
	

Note: If the holes on the long edge of the paper are on the left side of the tray, then a jam may occur.

- Load envelopes with the flap side down and on the left of the multipurpose feeder.



Warning—Potential Damage: Never use envelopes with stamps, clasps, snaps, windows, coated linings, or self-stick adhesives. These envelopes may severely damage the printer.

- Make sure the paper or specialty media is below the maximum paper fill indicator.

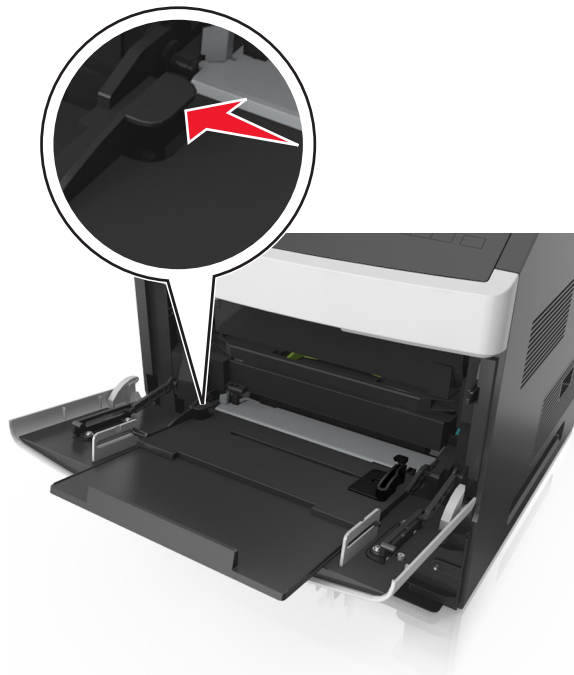

Warning—Potential Damage: Overfilling the feeder can cause paper jams.

- 6 For custom- or Universal-size paper, adjust the width guides to lightly touch the sides of the stack.
- 7 From the Paper menu on the printer control panel, set the paper size and type in the Paper menu to match the paper loaded in the tray.

Note: Set the correct paper size and type to avoid paper jams and print quality problems.

Setting the paper size and type

From the home screen navigate to:

 > **Paper Menu** > **Paper Size/Type** > select a tray > select the paper size or type > 