

International Business Machines Corporation

Information Products Division

Form No. S544-4213-1

Printed in USA

P/N 1432640

5/88

T. Lynch



Wheelwriter®6 Series II  
Typewriter 6784  
Operator's Guide

S544-4213-01



**Second Edition (May 1988)**

**The following paragraph does not apply to the United Kingdom or any country where such provisions are inconsistent with local law: INTERNATIONAL BUSINESS MACHINES CORPORATION PROVIDES THIS PUBLICATION "AS IS" WITHOUT WARRANTY OF ANY KIND, EITHER EXPRESS OR IMPLIED, INCLUDING, BUT NOT LIMITED TO, THE IMPLIED WARRANTIES OF MERCHANTABILITY OR FITNESS FOR A PARTICULAR PURPOSE. Some states do not allow disclaimer of express or implied warranties in certain transactions, therefore, this statement may not apply to you.**

This publication could include technical inaccuracies or typographical errors. Changes are periodically made to the information herein; these changes will be incorporated in later editions of the publication. IBM may make improvements and/or changes in the product(s) described in this publication at any time.

Publications are not stocked at the address below. For copies, contact your IBM Authorized Dealer.

You can send comments or suggestions using the form in the back of this manual. If the form has been removed, simply address your comments to the IBM Corporation, Dept. F98/962-3, 740 New Circle Road N.W., Lexington, KY 40511, USA. Information you supply may be used by IBM without obligation. You may, of course, use it yourself. Necessary changes will be made in later editions of the manual.

References to IBM products, programs, or services do not imply that IBM intends to make them available outside the United States.

© Copyright International Business Machines Corporation 1988. All Rights Reserved.

#### **FCC Notice**

The IBM Wheelwriter® 6 Series II Typewriter 6784 generates and uses radio frequency energy. If the typewriter is not installed and used in accordance with the installation instructions, operating instructions, and service manual, it may interfere with radio or television reception. This typewriter has been tested and found to comply with the limits for a Class B computing device pursuant to Subpart J of Part 15 of FCC rules, which are designed to provide reasonable protection against such interference when operated in a residential area.

If this typewriter interferes with radio or television reception, which can be determined by switching the typewriter off and on, the user is encouraged to try one or more of the following:

- Move the receiving antenna on the radio or television.
- Relocate the typewriter in relation to the radio or television.
- Plug the typewriter into a different electrical outlet from the radio or television.

If necessary, consult your IBM Authorized Dealer. If anyone other than an IBM Authorized Dealer modifies the typewriter and it causes interference, the user is responsible for correcting the interference.

## Safety Information

This machine has additional insulation which provides extra protection against the risk of electric shock and does not rely on grounding. This machine has a nongrounding-type (2-wire) power cord because grounding is not necessary.

For continued protection against the risk of electric shock and personal injury:

- Connect the machine only to an outlet of the correct voltage. The voltage your machine will accept is indicated on the machine.
- Make sure the machine is turned off (O) before you connect or disconnect the power cord or interconnecting cables.
- Do not use the machine in an area where it can become wet.
- Keep hair and personal articles away from moving parts in the machine to avoid the possibility of getting them caught.
- Refer service or repair to qualified service personnel.
- There may be some increased risks of electric shock and personal injury during disassembly and servicing of this machine. Professional service personnel should understand this and take necessary precautions.
- The safety features of some parts may not always be obvious. Therefore, replacement parts must have the identical or equivalent characteristics as the original parts.
- The maintenance information for this machine has been written for the professional service person and is not intended to be used by others.

## About Your Typewriter

Congratulations! You are about to experience typing with your new IBM Wheelwriter® Series II Typewriter.

This typewriter is designed with special functions such as Automat Centering and Underlining. These functions are designed to make your typing jobs easier, faster, more enjoyable, and productive.

The Storage function allows you to store jobs that you may need to change later. After you store a job, you can play it back and change without retyping the entire job.

In addition, you no longer have to retype frequently used jobs such as repetitive letters, repetitive paragraphs, and certain statistical reports.

The Decimal Tabulation function simplifies the job of aligning numbers.

This typewriter is like having many typewriters in one. You can type in either pica, elite, micro elite, or proportional spacing. Also, you have a choice of single, one-and-one-half, double, or triple spacing.

The alternate keyboard function allows you to type different languages and special characters, such as accent marks and other symbols.

Just tell your IBM typewriter what you want it to do!

The following option is available for your typewriter:

- Soundhood

The typewriter can also be upgraded to other models. For more information, contact your IBM Authorized Dealer.

---

## Contents

<b>Basic Operations</b> .....	1-1
Parts of the Typewriter .....	1-1
Keyboard Height Adjust Levers .....	1-2
Page End Indicator and Scale .....	1-3
Inserting Paper .....	1-4
Moving Paper .....	1-5
Removing Paper .....	1-5
Printwheel Identification .....	1-6
Choosing a Printwheel .....	1-6
Storing and Handling Printwheels .....	1-6
Automatic Pitch Selection .....	1-7
Margin/Pitch Scale .....	1-8
Cardholder .....	1-9
Margins .....	1-10
Tabs .....	1-12
Line Spacing .....	1-13
Code Key .....	1-14
Shift and Shift Lock Keys .....	1-15
Typematic (Repeat) Keys .....	1-16
Correction Memory .....	1-17
Erasing Automatically in 10, 12, or 15 Pitch .....	1-18
Erasing Manually in 10, 12, or 15 Pitch .....	1-22
<b>Advanced Operations</b> .....	2-1
Automatic Carrier Return .....	2-1
Required Spaces .....	2-3
Multiple Word Underline .....	2-5
Continuous Underline .....	2-6
Centering .....	2-7
Margin Return .....	2-9
Subscripts and Superscripts .....	2-10
Special Characters .....	2-11
Impression Control .....	2-12
Indenting .....	2-13
Caps Function .....	2-17
Decimal Tabulation .....	2-18
Backspace 1 .....	2-22
Erasing in Proportional Spacing (PS) .....	2-23

<b>Storage</b> .....	3-1
Storing a Job .....	3-2
Playing Back a Stored Job .....	3-5
Revising a Stored Job .....	3-7
Stop Code .....	3-16
Multipage Jobs .....	3-18
Hyphens at the Right Margin .....	3-20
Storage Helpful Hints .....	3-22
Deleting Storage .....	3-26
Storage Full Warning .....	3-27
Making Space Available in Storage .....	3-28
Storage Log .....	3-29
Repetitive Letters .....	3-31
Combining Stored Jobs .....	3-35
Addressing Envelopes .....	3-39
<b>Advanced Storage</b> .....	4-1
Directory .....	4-2
Mark .....	4-4
Justification .....	4-9
Justifying Parts of a Job .....	4-12
Multipage Jobs .....	4-13
Format Storage .....	4-17
Advanced Revision .....	4-20
Playing a Character, Word, or Line .....	4-21
Playing To a Word or Words .....	4-22
Playing All .....	4-23
Deleting a Character, Word, or Line .....	4-23
Deleting To a Word or Words .....	4-25
Deleting All .....	4-27
Using Advance to Move Forward Through Storage .....	4-27
Advancing a Character, Word, or Line .....	4-29
Advancing to a Word or Words .....	4-30
Repeat Advance .....	4-31
Advancing All .....	4-31
Copying a Job into Another Storage Area .....	4-32
<b>Alternate Keyboards</b> .....	5-1
Keyboard Alphabetic Cross-Reference .....	5-6
Keyboards for Special Applications .....	5-7
Alternate Keyboard Charts .....	5-8
Special Applications .....	5-17

<b>Problem Determination</b> .....	6
Problem Determination Index .....	6
Beeper and Light Signals .....	6
Erasing Problems .....	6
Typewriter Problems .....	6
Print Quality Problems .....	6
Typing Problems .....	6
<b>Reference</b> .....	7
Ordering Procedures for IBM Supplies .....	7
Typestyle Samples .....	7
Printwheel Application Recommendations .....	7
Removing the Printwheel .....	7
Installing the Printwheel .....	7
Ribbon Cassette System .....	7
Removing the Cassettes .....	7
Installing the Cassettes .....	7
Ribbon Application Recommendations .....	7-1
Ribbon Cassette Reorder Numbers .....	7-1
Batteries .....	7-1
Care and Maintenance .....	7-1
Serial Number .....	7-1
<b>Index</b> .....	X-

# Basic Operations

## Parts of the Typewriter

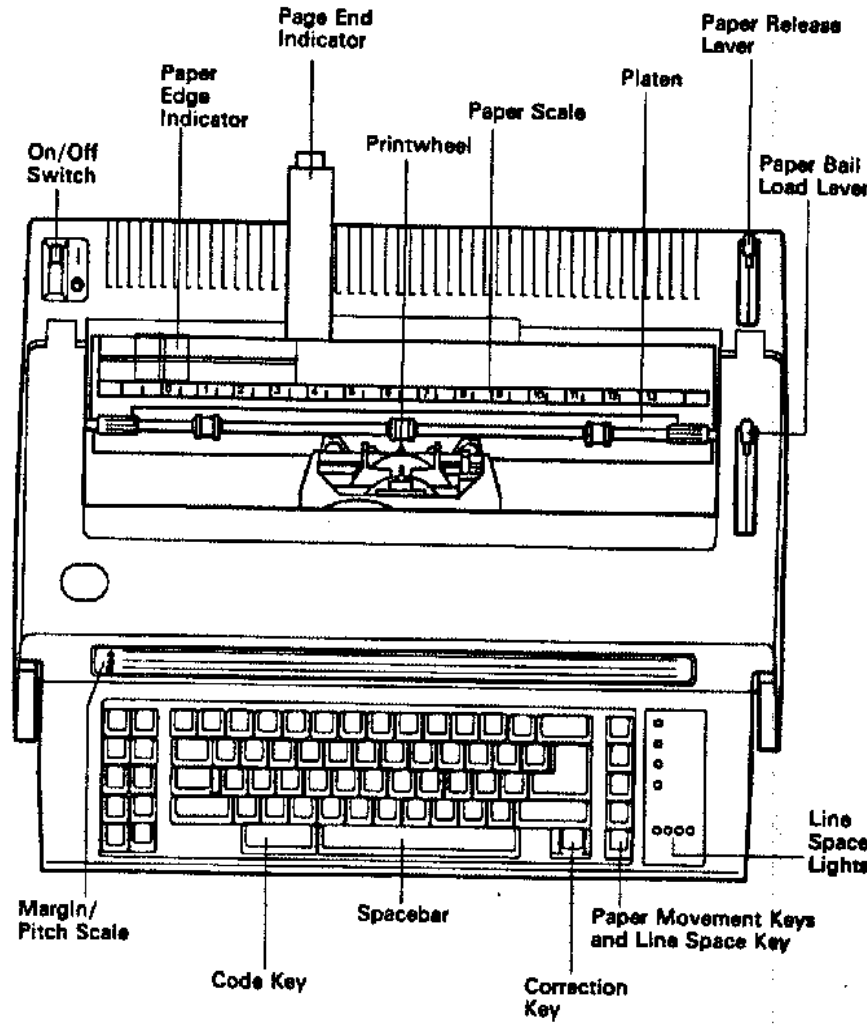

## Keyboard Height Adjust Levers

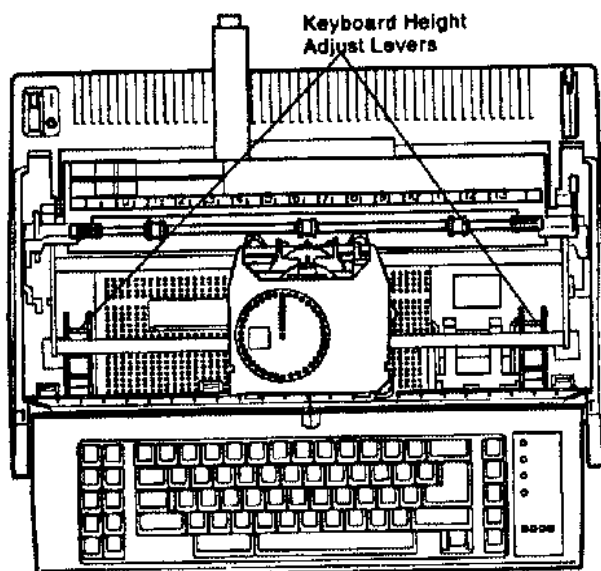

The keyboard can be raised or lowered to the most comfortable position by using the keyboard height adjust levers. There are three positions: low, medium, and high.

1. Use the Spacebar to move the carrier to the center of your typewriter.
2. Turn the typewriter off.
3. Raise the top cover.
4. Locate the two blue keyboard height adjust levers. They are located on the inside of the typewriter on the right and left sides of the bottom panel.
5. Push down on the levers and slide them to the desired position until they lock into place.
  - When the levers are all the way forward, the keyboard is in the *high* position.
  - When the levers are in the middle, the keyboard is in the *medium* position.
  - When the levers are all the way back, the keyboard is in the *low* position.
6. Make sure that you have both levers locked into the same position.

## Page End Indicator and Scale

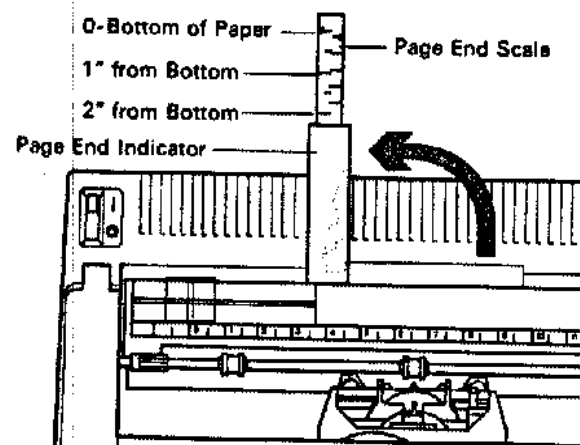

1. Raise the page end indicator until it is straight up.
2. Pull the page end scale all the way out until it locks into place.
  - As you type, the top of the paper comes out of the typewriter and moves up to the lines on the scale.
  - The lines on the scale tell you approximately how much space remains to the bottom of 27.9 cm (11 in) paper.
  - The left side of the scale is marked in inches. The right side is marked in centimeters.

## Inserting Paper

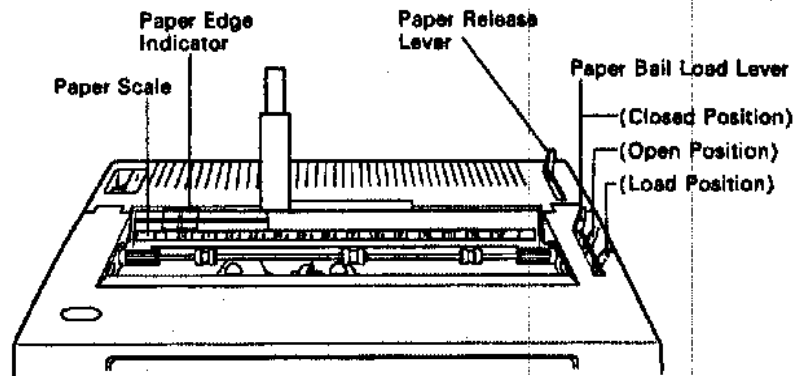

The typewriter has a paper bail load lever to assist you in loading the paper semiautomatically. The lever has three positions: closed, open, and load.

1. Make sure the typewriter is turned on.
2. Push the paper release lever all the way to the back of the typewriter.
3. Align the center of the paper edge indicator with the vertical line to the left of zero (0) on the paper scale.
4. Align the left edge of the paper with the vertical line in the center of the paper edge indicator.
5. Pull the paper bail load lever all the way forward to the load position. When the paper begins to feed, let go of the paper bail load lever.
  - The paper feeds to the top margin position.
6. Push the paper bail load lever all the way back until the paper bail holds the paper against the platen.

**Note:** When inserting loose carbon copies (five maximum), pull the paper release lever forward. Insert the copies, then push the lever all the way back.

## Moving Paper

You have four keys to move your paper up or down in the typewriter: Paper Up, Paper Down, Micro Up, and Micro Down.



- Press **Paper Up** to move the paper up one-half line.
- Press **Paper Down** to move the paper down one-half line.
- Press **Micro Up** to move the paper up 1/48 of an inch.
- Press **Micro Down** to move the paper down 1/48 of an inch.

## Removing Paper

1. Pull the paper bail load lever toward you.
2. Pull the paper release lever toward you.
3. Remove the paper.
4. Push the paper release lever back.
5. Push the paper bail load lever back.

**Note:** You may also press and hold down the **Paper Up** key or pull the paper bail load lever forward several times to remove paper.



## Printwheel Identification

Your typewriter uses an IBM Cartridge Printwheel II. Printwheels are available in many different typestyles and pitches. See pages 7-1 through 7-3 for typestyle samples and a list of typestyles. You can choose from four different pitches as shown in the chart on page 1-7.

The illustration below shows where to find the typestyle, pitch, and reorder number on the printwheel.

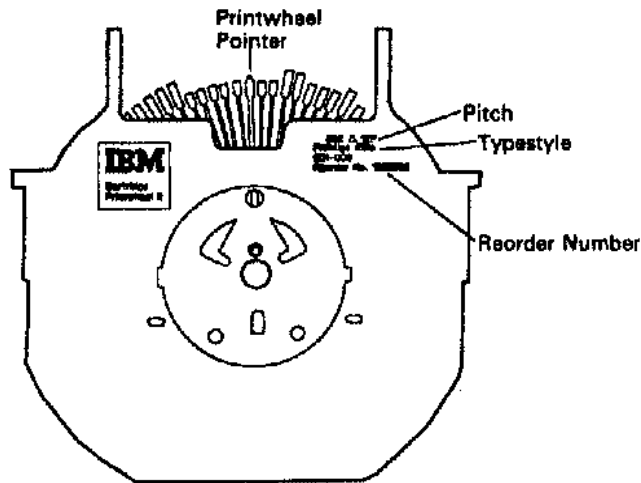

## Choosing a Printwheel

A printwheel in 10 or 12 pitch is recommended for use while you are learning to use your typewriter. All examples or practices in this manual are illustrated in 12 pitch.

## Storing and Handling Printwheels

The printwheel petals can be damaged by paper clips, staples, or other objects. When printwheels are not being used, always store them in a clean, flat area.

## Automatic Pitch Selection

The correct pitch is automatically selected by the typewriter when you install a printwheel. The pitch determines the number of characters typed per horizontal inch.

The following table summarizes printwheel pitches with print examples of each pitch.

Pitch (Type Size)	Characters Per Inch	Pitch Symbol	Print Example
10P (Pica)	10	▲	This is a sample.
12P (Elite)	12	△	This is a sample.
PS (Proportional Spacing)	Varies in Width	●	This is a sample.
15P (Micro Elite)	15	■	This is a sample.

## Lines Per Vertical Inch

A printwheel for 10, 12, or PS pitch prints six lines per vertical inch.  
A printwheel for 15 pitch prints eight lines per vertical inch.

## Helpful Hints

- If you change to a printwheel in a different pitch, your margins and tabs may change. Be sure to always press Code after changing the printwheel.
- You can use format storage to save and recall your margins and tabs.

## Margin/Pitch Scale

The typewriter has three margin scales: 10▲, 12△, and 15■. When typing, use the scale line that matches the pitch symbol on your printwheel.

- For 10▲ pitch (pica) type, use the upper scale.
- For 12△ and PS ● pitch (elite and proportional spacing) type, use the middle scale.
- For 15■ pitch (micro elite) type, use the lower scale.

An orange pointer moves along the scale on your typewriter to show the position of the next character to print.

The margin/pitch scale also contains centering marks. When the left edge of the paper lines up with zero on the margin/pitch scale:

- marks the approximate center of paper 215.90 mm (8.50 in) wide.
- marks the approximate center of paper 210 mm (8.27 in) wide.

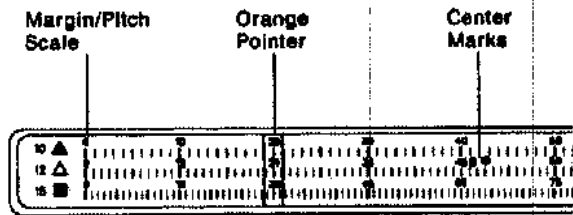

## Cardholder

The cardholder holds paper, cards, and envelopes against the platen.

The printwheel pointer shows the position where the next character will print.

The top red portion (A) of the cardholder indicates the base of the printing line. As the typewriter prints, the bottom of each character rests just above the line, as shown below.

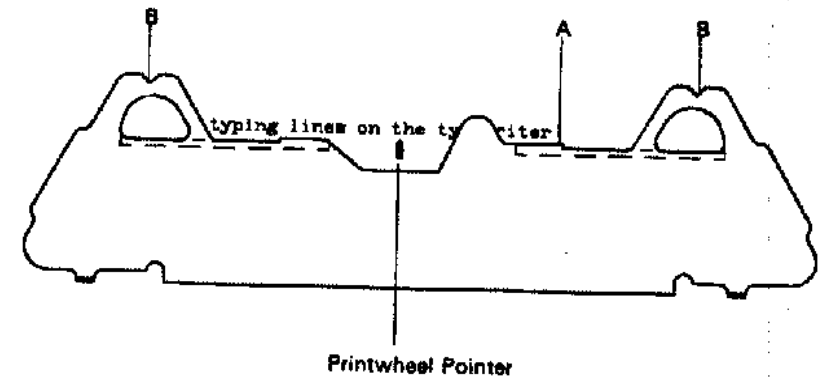

You may use the notches (B) to draw vertical lines.

- Hold a pencil or pen against one of the notches while pressing **Paper Up**, **Paper Down**, **Micro Up**, or **Micro Down** to move the paper.

## Margins

### Setting the Left Margin

1. Press **Spacebar** or **Backspace** to move the carrier to the desired left margin position.
2. Press **LMar**.
  - The printwheel spins when the left margin is set.

### Setting the Right Margin

1. Press **Spacebar** or **Backspace** to move the carrier to the desired right margin position.
2. Press **RMar**.
  - The printwheel spins when the right margin is set.
  - To check the right margin setting, space toward the right margin and listen for a beep. You should hear the beep approximately five spaces before the right margin setting.

### Releasing the Left Margin

1. Return the carrier to the left margin.
2. Press **MarRel**.
  - The printwheel spins.
3. Backspace through the left margin.
  - To set a new left margin, backspace to the desired position, then press **LMar**. The old margin is automatically eliminated.

## Saving Margins

Your typewriter automatically saves four sets of margins: one set for each pitch (10, 12, PS, and 15).

Your typewriter has a battery pack to save margins when you turn the typewriter off. Keep batteries installed at all times and replace them once a year. See pages 7-12 through 7-14.

## Helpful Hints

- When you change to a printwheel in a different pitch, your margins may change.
- You can type, tab, or space through the right margin without a beep.
- When you press **CRIn** after setting margins, the paper moves to the right margin.
- Press **MarRel** when the carrier is positioned at the left margin and backspace to set a new left margin.
- You do not have to press **MarRel** to set a new right margin.
- The old margin is automatically eliminated when a new margin is set.

## Tabs

### Setting a Tab

1. Press **Spacebar** or **Backspace** to move the carrier to the desired tab position.
2. Press **TSet**.
  - The printwheel spins when the tab is set.
3. Repeat these steps to set each additional tab. You can set a tab at every space on the margin/pitch scale.

### Clearing a Tab

1. Press **Tab** to move to the tab stop you want to clear.
2. Press **TClr**.
  - The printwheel spins when the tab is cleared.
3. Repeat the steps to clear each individual tab.

### Clearing All Tabs

Hold down **TClr** while you press **CRln**.

- The carrier returns to the left margin.
- All tabs are cleared.
- The carrier may be at any position to clear all tabs.

### Saving Tabs

Your typewriter has a battery pack to save tabs when you turn the typewriter off.

Your typewriter automatically saves four sets of tabs: one set for each pitch (10, 12, PS, and 15).

### Helpful Hints

- When you change to a printwheel in a different pitch, your tabs may change.
- You can tab, type, or space through the right margin.
- When you press **Tab**, the carrier will not stop at the right margin unless a tab stop is set at the right margin.
- The carrier may be at any position to clear all tabs.

## Line Spacing

Your typewriter lets you choose four line space settings: 1, 1½, 2, or 3. Line spacing is the amount of space between the lines of type.

The **Line Space** indicator lights tell you which line spacing you are using.

### Setting Line Spacing

Press the **Line Space** key.

- Keep pressing the key until the desired **Line Space** light is on.

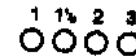

### Helpful Hints

- The paper moves one-half line up or down when you press **Paper Up** or **Paper Down** regardless of the line space setting.
- The paper moves 1/48 of an inch up or down when you press **Micro Up** or **Micro Down** regardless of the line space setting.
- When you select a line space setting, it will not change until you press **Line Space** or turn the typewriter off.
- The line spacing resets to 1 (single space) when you turn the typewriter off.

## Code Key

The **Code** key is used with other function keys on the typewriter. The **Code** key and some of the function keys have *green* letters on them. The other function keys used with **Code** which do not have *green* lettering are: **Q**, **Hyphen**, and **Spacebar**.

When you use two keys at a time, hold down **Code** (the first key) while you press the function key.



The keys that are used in combination with the **Code** key are shaded in the keyboard chart below.

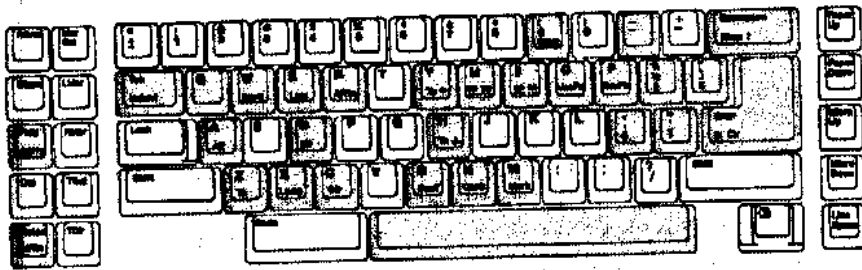

## Helpful Hints

You can use more than one coded function at a time. For example, you can use Automatic Centering and Underlining together.

## Shift and Shift Lock Keys

Use the **Shift** and **Shift Lock** keys (**Shift** and **Lock**) to type uppercase characters (all capitals).

The **Lock** key allows you to type continuously in uppercase without pressing the **Shift** key each time. A **Shift Lock** indicator light comes on to let you know that **Shift Lock** is on.

### Locking Shift

Press **Lock**.

- The **Shift Lock** light comes on.
- All characters print in uppercase.

### Unlocking Shift

Press either the left or right **Shift** key to unlock the **Lock** key.

- The **Shift Lock** light goes off.

## Typematic (Repeat) Keys

Typematic (repeat) keys have both a single and a repeat action. Any of these keys can be touched briefly for a single action or held down for repeat action.

Asterisk/8  
Backspace/Bksp 1  
Carrier Return  
Correction Key  
Micro Down  
Micro Up  
Paper Down  
Paper Up  
Period  
Plus/Equal  
Question Mark/Slash  
Spacebar  
Underline/Hyphen  
X, x

For example, if you press the letter X, an X prints on your paper. If you hold down the X key for more than one-half second, X prints repeatedly until you release the key.

## Correction Memory

Just as you remember what you read, your typewriter remembers what you type. In other words, your typewriter has a correction memory that remembers approximately the last 200 characters you type.

The correction memory makes erasing characters very easy and automatic. The correction memory is present when you turn your typewriter on.

**Note:** There are two ways to erase characters: *automatically* and *manually*.

### Automatic Erase

Automatic erasing (within the correction memory) allows you to erase incorrect characters: noticed immediately, farther back on the same line, on previously typed lines, up to approximately the last 200 characters.

### Manual Erase

Manual erasing (outside the correction memory) allows you to erase incorrect characters: farther back than approximately 200 characters, that are not erased automatically.

#### Example

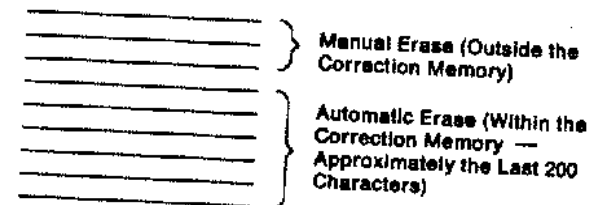

## Erasing Automatically in 10, 12, or 15 Pitch

### Erasing a Character You Notice Immediately



Correction  
Key

Press the **Correction** key.

- The character is automatically erased.

#### Example

Thi  
Th

### Erasing a Character Farther Back on the Same Line

1. Press **Backspace** to move the printwheel pointer to the incorrect character.
2. Press the **Correction** key.
  - The character is automatically erased.
3. Type the correct character.
4. Press **Reloc**.
  - Use of **Reloc**, within the correction memory, will return the carrier to the last typing position.
5. Continue typing.

### Practice

1. Set margins.
  - You will use these margin settings until instructed to change them.

<b>12 Pitch</b>	or	<b>10 Pitch</b>
L Mar 24		L Mar 20
R Mar 80		R Mar 75

2. Type the line printed below, including the highlighted error. When you reach the ✓, stop typing.
  - a. Use **Backspace** to move the carrier back to the incorrect character, then press the **Correction** key to erase it.
  - b. Type an **a**, then press **Reloc**, and continue typing.

You may need to correct errors farther back ✓ on the

## Erasing on Previous Lines

1. Press **Paper Down** to move the carrier to the line with the incorrect character.
  - Use **Paper Up** if you move back too many lines.
2. Press **Spacebar** or **Backspace** to position the printwheel pointer at the incorrect character.
  - If you are erasing several characters in a word, or the entire word, position the printwheel pointer at the *last incorrect character in the word*. Look at the example below:

**Last Incorrect Character**

The Central School District has

**Position Printwheel Pointer Here**

3. Press the **Correction** key until each incorrect character in the word is erased.

Look at the example below.

The Central School District has

- If the incorrect character is not erased, be sure the carrier is not above or below the typing line.
4. Type the correct characters as shown below.

The Central School District has

5. Repeat steps 1 through 4 until all corrections have been made.
6. Press **Reloc** and continue typing.

## Practice

Type the following paragraph line by line as printed below, including the highlighted errors. Do not remove the paper from your typewriter.

The Central School District has been granted funds to establish a Demonstration Center to serve this entire area. (Do not press CRtn.)

Erase the incorrect characters using the following steps:

1. Press **Paper Down** two times to move the carrier to the line with the incorrect character (the second line).
  - If you move too far, press **Paper Up**.
  - Remember, the paper moves one-half line each time you press **Paper Down** or **Paper Up**.
2. Press the **Spacebar** to move the printwheel pointer to **e**.
  - If you space too far, press **Backspace**.
3. Press the **Correction** key.
  - The **e** is automatically erased.
4. Type **a** (the correct character).
5. Press **Paper Down** two times, then press the **Spacebar** to move the printwheel pointer to **c** (the last incorrect character in the word).
6. Press the **Correction** key two times.
  - The **t** and **c** are automatically erased.
7. Type **at** (the correct characters).
8. Press **Reloc**.



## Erasing Manually in 10, 12, or 15 Pitch

1. Press **Paper Down** to move the carrier to the line with the incorrect character.
  - Press **Paper Up** if you move back too many lines.
2. Press **Spacebar** or **Backspace** to position the printwheel pointer at the incorrect character.
  - If you are erasing the entire word or several characters in the word, position the printwheel pointer at the last incorrect character in the word.

Look at the example below.

### Position Printwheel Here

The world's first duel with typewriters was fought in Cincinnati, Ohio, in 1888. A Cincinnati, Louis Taub, challenged Frank McGurkin, a Salt Lake City court typist, to a contest consisting of 45 minutes of direct dictation and 45 minutes of copying.

} Outside the Correction Memory  
Within the Correction Memory (Approximately the Last 200 Characters)

3. Press the **Correction** key.
  - The printwheel spins.
4. Type the incorrect character.
  - The incorrect character is erased.
5. If you are erasing several characters from right to left, press the **Correction** key again and type the next incorrect character.
  - You do not need to press **Backspace** when erasing from right to left. The carrier moves to the left when you type the next incorrect character.
6. Repeat steps 3 and 4 to manually erase each incorrect character.
7. Type the correct characters.

## Practice

Type the following paragraph, line by line as printed below, including the highlighted errors. Do not remove the paper from your typewriter. Manually erase the incorrect characters after you type the entire paragraph.

The world's first duel with typewriters was fought in Cincinnati, Ohio, in 1888. A Cincinnati, Louis Taub, challenged Frank McGurkin, a Salt Lake City court typist, to a contest consisting of 45 minutes of direct dictation and 45 minutes of copying.  
(Do not press CRtn.)

1. Press **Paper Down** *twelve* times to move the carrier to the line with the incorrect characters (the first line).
2. Press **Spacebar** to move the printwheel pointer to the *t* in *wiht* (the last incorrect character in the word).
3. Press the **Correction** key.
4. Type *t*.  
The *t* is erased.
5. Press the **Correction** key.
6. Type *h*.  
The *h* is erased.
7. Type *th*.
8. Press the **Spacebar** to move the printwheel pointer to the incorrect *r* in *typewrrter*.
9. Press the **Correction** key.
10. Type *r*.
  - The *r* is erased.
11. Type *t*.

## Helpful Hints

- Always erase from right to left, then type the correct characters.
- If the printwheel spins when you press the Correction key, and the incorrect character is *not* erased:
  - Type the incorrect character again, just like you typed it the first time, and it is erased.
- Use the Correction key to erase unwanted carrier returns. For example, if you accidentally press CRtn, press the Correction key until the carrier moves to the end of the previous line.
- After you perform any of the following typewriter functions (even if you are within approximately the last 200 characters), you may have to use manual erase.
  - Pull the paper ball load lever forward to advance the paper.
  - Remove the printwheel.
  - Set or clear a temporary left margin.
  - Press Store or hold down Store while you press a number.
  - Press Paper Down or Micro Down and type on a new line.
  - Hold down Code while you press O (UseFm).
- When manually erasing a symbol created by two or more characters, for example (ø), erase each character individually. Then type the correct character or symbol.
- To manually erase underlined characters, turn Underline on and then erase the incorrect character.

---

## Advanced Operations

---

### Automatic Carrier Return

With Automatic Carrier Return (ARtn) on, you do not have to press CRtn when you reach the right margin. When the beep sounds as the carrier moves toward the right margin, continue typing. The carrier automatically returns to the left margin when you press the Spacebar near the right margin.

**Note:** Be sure Automatic Carrier Return is off when typing tables, columns, or heavily formatted material.

### Turning Automatic Carrier Return On

Hold down Code while you press R (ARtn).

- The ARtn light comes on.
- The printwheel spins.

### Turning Automatic Carrier Return Off

Hold down Code while you press R.

- The ARtn light goes off.
- The printwheel spins.

## Practice

1. Insert paper and set margins.

12 Pitch	or	10 Pitch
L Mar 30		L Mar 25
R Mar 72		R Mar 65

2. Type the following paragraph with **ARtn** on, and correct only the errors that you notice immediately.
  - Your line endings will not match the printed copy below when you have **ARtn** on.

**Note:** Do not press **CRtn** at the end of the lines except where marked.

### Code + R (ARtn)

The world's first duel with typewriters was fought in Cincinnati, Ohio, in 1888. A Cincinnati, Louis Taub, challenged Frank McGurkin, a Salt Lake City court typist to a contest consisting of 45 minutes of direct dictation and 45 minutes of copying from a script. **CRtn** Code + R (ARtn)

## Helpful Hints

- When the **ARtn** light is on, you do not have to press **CRtn** at the end of each line. The typewriter will automatically return the carrier to the left margin.
- If you need to end a line before you reach the right margin, press the **CRtn** key. Some examples of short lines are: date, inside address, salutation, short last line in a paragraph, closing, and short headings.
- Do not use Automatic Carrier Return when typing tables, columns, forms, or heavily formatted material.

## Required Spaces

When the **ARtn** light is on, the carrier automatically returns when you type a space near the right margin.

There are times when you do not want the carrier to return automatically. For example, you do not want the carrier to return automatically between names and dates at the right margin. You want the typewriter to keep them on the same line.

The carrier does not automatically return when you type a required space. Therefore, required spaces typed between words keep them on the same line.

## Typing a Required Space

When the beep sounds at the right margin while you are typing words that must be kept on the same line:

1. Finish the word you are typing.
2. Hold down **Code** while you press **Spacebar**.
  - If you accidentally press **Spacebar** and the carrier returns, press the **Correction** key until the carrier moves back to the previous line. Then hold down **Code** while you press **Spacebar**.
3. Type the next word.
4. Continue typing required spaces between words that must be kept together.
5. When you type the last word on the line, press the **Spacebar** to return the carrier automatically.

## Practice

1. Insert paper and set margins.

12 Pitch	or	10 Pitch
L Mar 36		L Mar 30
R Mar 72		R Mar 65

2. Make sure the **ARtn** light is on.
3. Type the line below using *regular* spaces between words in the date.
  - The carrier automatically returns between *August* and *12*.
4. Type the same line again using *required* spaces between words in the date.
  - The typewriter keeps the date on the same line.

Code + Spacebar

The convention will be held August 12, 1984.

## Multiple Word Underline

### Turning Multiple Word Underline On

Hold down **Code** while you press I (**aa aa**).

- The printwheel spins.
- Everything you type *except* spaces will be underlined until you turn Multiple Word Underline off.

**Note:** If the printwheel does not spin, make sure Continuous Underline is turned off.

### Turning Multiple Word Underline Off

Hold down **Code** while you press I.

- The printwheel spins.
- The typewriter stops underlining.

### Helpful Hints

- If you are within the correction memory, the characters and underlines are automatically erased when you press the **Correction** key.
- To manually erase underlined characters, turn Underline on and then erase the incorrect characters.
- If you want to add underlined text or turn Underline on under text you have already typed, you must:
  - Play up to the point where you want to start underlining or add text.
  - Turn Underline on.
  - Play through the text you want underlined or type the new text.
  - Turn Underline off.

## Continuous Underline

### Turning Continuous Underline On

Hold down **Code** while you press **U** (aa aa).

- The printwheel spins.
- Everything you type will be underlined until you turn Continuous Underline off.

**Note:** If the printwheel does not spin, make sure Multiple Underline is turned off.

### Turning Continuous Underline Off

Hold down **Code** while you press **U**.

- The printwheel spins.
- The typewriter stops underlining.

### Helpful Hints

- If you are within the correction memory, the characters and underlines are automatically erased when you press the **Correction** key.
- To manually erase underlined characters, turn Underline on and then erase the incorrect characters.
- Spaces created by a tab are not underlined.
- If you want to add underlined text or turn Underline on under text you have already typed, you must:
  - Play up to the point where you want to start underlining or add text.
  - Turn Underline on.
  - Play through the text you want underlined or type the new text.
  - Turn Underline off.

## Centering

You can automatically center words between the left and right margins or at any point on the page.

### Centering Between the Left and Right Margins

1. Press **CRtn**.
  - The carrier must be positioned at the left margin.
2. Hold down **Code** while you press **C** (**Ctrl**).
  - The printwheel spins.
  - The carrier moves to the center point between the margins.
3. Type the words you want centered.
  - As you type, the carrier backs up without printing.
  - If you make an error, press the **Correction** key and type the correct character.
4. Hold down **Code** while you press **C**.
  - The words print.

**Note:** The centered words also print when you press **Tab**, **DecT** or **CRtn**.

### Centering at Any Point on the Page

1. Press **Tab** or **Spacebar** to position the carrier at the desired center point.
2. Hold down **Code** while you press **C**.
  - The printwheel spins.
3. Type the words you want centered.
  - As you type, the carrier backs up without printing.
4. Hold down **Code** while you press **C**.
  - The words print.

**Note:** The centered words also print when you press **Tab**, **DecT** or **CRtn**.

## Helpful Hints

- To cancel centered characters before they print:
  1. Press the **Correction** key until the carrier stops moving forward.
  2. Hold down **Code** while you press **C (Ctr)**, **Tab**, **DecT**, or **CRtn**.
- To change a printwheel in a centered heading, type a stop code at the point where you want to change the printwheel.

## Margin Return

The Margin Return function is very useful when incorrect characters near the beginning of a line need to be erased or when you are setting up tabs. To use the **MRtn** key, hold down **Code** while you press **Reloc (MRtn)**. Use the **Reloc** key to return the carrier to the original typing position.

## Practice

Type the line printed below, including the highlighted error. When you reach the ✓, stop typing.

1. Hold down **Code** while you press **Reloc (MRtn)** to move the carrier back to the first character on the line, then use the **Spacebar** to move to the incorrect character *l*. Press the **Correction** key to erase it.
2. Type a *u*, then press **Reloc** and continue typing.

You may need to correct errors farther back ✓ on

## Subscripts and Superscripts

Subscripts are typed *below* the writing line (for example,  $\text{CuSO}_4$ ).

Superscripts are typed *above* the writing line (for example, *Happy Living*<sup>5</sup>).

### Typing Subscripts

1. Hold down **Code** while you press **H** ( $\frac{1}{2}\downarrow$ ).
  - The carrier is positioned one-half line below the typing line.
2. Type the subscript.
  - The carrier automatically returns to the typing line.

### Typing Superscripts

1. Hold down **Code** while you press **Y** ( $\frac{1}{2}\uparrow$ ).
  - The carrier is positioned one-half line above the typing line.
2. Type the superscript.
  - The carrier automatically returns to the typing line.

### Helpful Hints

- To automatically erase a subscript or superscript, press the **Correction** key.
  1. The paper will automatically move up or down a half line.
  2. The subscript or superscript will be erased.
  3. The paper returns to the original line.
- To erase subscripts or superscripts farther back than approximately the last 200 characters:
  1. Space to the position where the subscript or superscript is typed.
  2. Hold down **Code** while you press **H** ( $\frac{1}{2}\downarrow$ ) or **Y** ( $\frac{1}{2}\uparrow$ ).
  3. Press the **Correction** key.
  4. Type the subscript or superscript.
    - The subscript or superscript is erased.
  5. Hold down **Code** while you press **H** ( $\frac{1}{2}\downarrow$ ) or **Y** ( $\frac{1}{2}\uparrow$ ) to type the correct subscript or superscript.
- It is not recommended to use **Code** + **U** (aa aa) while typing subscripts or superscripts.

## Special Characters

Your typewriter has four special characters that you can print by using the **Code** key: ¶, §, <sup>2</sup>, <sup>3</sup>. You can print these characters without changing the printwheel.

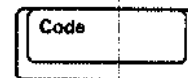

A section symbol ( § ) prints.

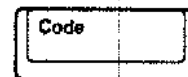

A paragraph symbol ( ¶ ) prints.

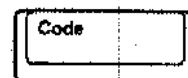

An exponent ( <sup>2</sup> ) prints.

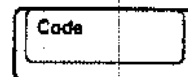

An exponent ( <sup>3</sup> ) prints.

### Helpful Hints

To erase special characters manually:

1. Position the carrier at the special character.
2. Press the **Correction** key.
  - The printwheel spins.
3. Hold down **Code** while you press the special character.
  - The special character is erased.

## Impression Control

There are two impression control settings:

- Normal
- Heavy

The impression control is set to normal when you turn the typewriter on. When the typewriter is turned off, the impression is reset to normal.

Use the impression control anytime you need a heavier impression.

### Setting the Impression Control to Heavy

Hold down **Code** while you press **Q**.

- Impression becomes heavy.

### Setting the Impression Control to Normal

Hold down **Code** while you press **Q**.

- Impression returns to normal.

## Indenting

Hold down **Code** while you press **Tab** (Indent) to set a *temporary* left margin for indented lines. When you set a temporary left margin, you do not have to press **Tab** at the beginning of each indented line.

Here are examples of temporary left margins:

\_\_\_\_\_  
\_\_\_\_\_  
\_\_\_\_\_

• \_\_\_\_\_  
• \_\_\_\_\_  
• \_\_\_\_\_

\_\_\_\_\_  
\_\_\_\_\_  
\_\_\_\_\_

1. \* \_\_\_\_\_  
\* \_\_\_\_\_  
\* \_\_\_\_\_

a. \* \_\_\_\_\_  
\* \_\_\_\_\_  
\* \_\_\_\_\_

b. \* \_\_\_\_\_  
\* \_\_\_\_\_  
\* \_\_\_\_\_

\*Temporary Left Margin



## Setting a Temporary Left Margin

1. Type until you reach the *first* line of the indented lines.
2. Space or tab to move the carrier to the desired temporary left margin position.
3. Hold down **Code** while you press **Tab (Indent)** to set a temporary left margin.
  - The printwheel spins.
  - A temporary left margin is set.

## Typing

Type the indented lines.

- If the **ARtn** light is on, the carrier automatically returns to the temporary left margin.

## Clearing the Temporary Left Margin

When you finish typing the indented lines, hold down **Code** while you press **CRtn (InClr)**.

- The carrier returns to the original left margin.
- The temporary left margin is cleared.

## Practice

1. Set margins and tabs.

<b>12 Pitch</b>	or	<b>10 Pitch</b>
L Mar 12		L Mar 10
R Mar 42		R Mar 40
Tab at 17		Tab at 15

2. Type the first paragraph printed below.
3. Space or tab to position the carrier to type the indented (second) paragraph.
4. Set a temporary left margin by holding down **Code** while you press **Tab**.
5. Type the indented paragraph.
6. Hold down **Code** while you press **CRtn (InClr)** to clear the temporary left margin.
7. Type the last paragraph.

Your new IBM typewriter is designed to make typing easier and more enjoyable.

For example, centering, underlining, and indenting are done automatically on this new typewriter.

Try using these new functions to help you with your work!

## Helpful Hints

- To cancel a temporary left margin, hold down **Code** while you press **CRtn (inClr)**.
  - The **Correction** key will not cancel a temporary left margin.
- To erase other characters after setting or clearing a temporary left margin (as in the example below):

Incorrect Character

Code + Tab (Indent)

12. The world's first duel with

1. Press **Backspace** until the carrier stops at the temporary left margin.
2. Press **MarRel**.
3. Press **Backspace** to position the carrier at the 2 (the incorrect character).
4. Manually erase the 2 (the incorrect character), and then type a 3.
5. Continue typing.
  - The temporary left margin is still set.

## Caps Function

The Caps function allows you to type capital letters while typing numbers and lowercase punctuation without using the **Shift** or **Shift Lock** key.

### Turning Caps On

1. The **Shift Lock** light must be turned off.
  - If necessary, press **Shift** to turn the light off.
2. Hold down **Code** while you press **N (Caps)**.
  - The printwheel spins.
  - All letters are typed in uppercase (capital letters).
  - All numbers and punctuation are typed in lowercase.

### Turning Caps Off

Hold down **Code** while you press **N (Caps)**.

- The printwheel spins.
- All letters return to lowercase.

### Helpful Hints

- While Caps is turned on, press the **Shift** key to type uppercase symbols (on the numbers row) and uppercase punctuation marks.
- The Caps function can be used only with the United States keyboard.

## Decimal Tabulation

Use the Decimal Tab function to type numbers in vertical columns. You can align numbers on decimal points or at the column's right edge. Use **Code + B (DecT)** to automatically align columns of numbers.

## Typing Columns with Decimals

Set *regular* tabs at the desired decimal point in each column as shown below:

Set Tab Here	Set Tab Here	Set Tab Here
234.56	456.79	1.3
2.87	20.13	.5

1. Start at the left margin.
2. Hold down **Code** while you press **B (DecT)**.
  - The carrier moves to the first tab stop.
  - If you accidentally press **Tab** instead of **DecT**, press the **Correction** key until the tab is erased, then hold down **Code** while you press **B**.
3. Type the numbers in the column and the decimal point.
  - The carrier moves back without printing.
  - The numbers print when you type the decimal point or press **Tab**, **CRtn**, or the appropriate key(s) for decimal tab.
4. Type numbers or characters after the decimal point.
5. Hold down **Code** while you press **B** to move to the tab stop in the next column, or press **CRtn** to return to the left margin.

**Note:** The decimal point may be a period or comma depending on the keyboard language selected for alternate language keyboards.

## Typing Columns without Decimals

Set *regular* tabs at the right edge of each column. See the example below:

Set Tab Here	Set Tab Here	Set Tab Here
26,745	87,453	873
387	3,498	34

1. Start at the left margin.
2. Hold down **Code** while you press **B (DecT)**.
  - The carrier moves to the tab stop in the first column.
  - If you accidentally press **Tab** instead of **DecT**, press the **Correction** key until the tab is erased, then hold down **Code** while you press **B (DecT)**.
3. Type the numbers in the column.
  - The carrier moves back without printing.
  - The numbers print when you press **Tab**, **CRtn**, or the appropriate key(s) for decimal tab.
4. Hold down **Code** while you press **B** to move to the tab stop in the next column, or press **CRtn** to return to the left margin.

## Practice

1. Hold down **TClr** while you press **CRtn** to clear all tabs.
2. Set margins and tabs.

12 Pitch	or	10 Pitch
L Mar 12		L Mar 10
Tabs 27, 42		Tabs 25, 40
3. Type the table below using **Code + B (DecT)** to automatically align each column at the decimal point.

333.33	5,555.00
16,000.00	2.37
28.99	329.87
4. Type the table below using **Code + B (DecT)** to automatically align columns without decimals.

38,765	7,658
976	229

## Helpful Hints

- To cancel the Decimal Tab function before the number prints:
  1. Press the **Correction** key until the carrier stops moving forward.
  2. Press **Tab**, **Spacebar**, **Backspace**, or **CRtn**.
- When using a proportional spacing (PS) printwheel, always type the number *1* (on the numbers row). Never use the letter *l* for the number *1*.
- After typing a number, always press **Tab**, **CRtn** or the appropriate key(s) for decimal tab to print the number before performing another operation (for example, making corrections on a previous line).
- If columns *without* decimals contain additional information (for example, 3,865%):
  1. Use **Code + B (DecT)** to align the numbers in the column (3,865).
  2. Press **CRtn** or **Tab** to print the numbers.
  3. Press the **Correction** key to return the carrier to the right edge of the column.
  4. Type the additional information (%).
- To underline numbers in a column:
  1. Hold down **Code** while you press **B**.
    - The carrier moves to the first tab stop.
  2. Turn Underline on.
    - Hold down **Code** while you press **U (aa aa)**.
  3. Type the number.
    - Type any leading blank spaces that appear before the number in the column if you want the space underlined.
  4. Turn Underline off.
    - Hold down **Code** while you press **U (aa aa)**.
  5. Hold down **Code** while you press **B** to move to the next tab stop.
  6. Continue typing each number by repeating steps 1 through 5.

## Helpful Hints (continued)

- To double underline numbers in a column:
  1. Use Underline while typing each number.
    - See the steps above "To underline numbers in a column."
  2. Press **CRtn** after the last number.
  3. Turn Underline off.
    - Hold down **Code** while you press **U (aa aa)**.
  4. Press **Paper Down** until the carrier is positioned one-half line below the first underline.
  5. Space to each column and manually type the second underline (**Shift + -**).

## Backspace 1

Holding down **Code** while you press **Backspace (Bksp1)** moves the carrier back one *unit* of space.

Use the one-unit backspace (**Bksp1**) key when you want to insert an extra character in a word.

## Inserting an Extra Character

1. Position the printwheel pointer at the last character in the incorrect word. Look at the example below.

Position Printwheel Pointer Here

The letters should be

2. Press the **Correction** key until the incorrect word is erased.
3. Hold down **Code** while you press **Bksp1** two or three times (for any pitch) to move the printwheel pointer back a fraction of a space.
4. Type the correct word.
5. Press **Reloc** and continue typing.

## Practice

Type the following line. When you reach the ✓, stop typing and correct the word *should*. If you need help, use the instructions above.

The letters should be received by our ✓

## Erasing in Proportional Spacing (PS)

Complete this section only if you have a PS (proportional spacing) printwheel. Do not complete this section if you are using a printwheel in 10, 12, or 15 pitch. If you need help changing the printwheel, see "Removing the Printwheel" on page 7-6 and "Installing the Printwheel" on page 7-7.

The space allotted to each character depends on its width in proportional spacing. The space is measured in units. For example, a lowercase *m* is seven units wide and a lowercase *i* is three units wide. In 10, 12 and 15 pitch, each character is allotted the same space, regardless of its width.

In proportional spacing (PS), it is usually easier to erase the entire word containing an incorrect character, and then retype the word correctly. Using the **Correction** key, you *can* erase a single letter.

When erasing automatically or manually, position the printwheel pointer at the left edge of each incorrect character.

### Example

Time

Position the printwheel pointer here to erase the s.

## Erasing Automatically in Proportional Spacing

1. Use the **Backspace** key to position the printwheel pointer at the left edge of the *last* character in the word.
2. Press the **Correction** key.
  - The last character in the word is automatically erased.
  - If the character is *not* erased, you are outside the correction memory. The word must be erased manually.
3. Press the **Correction** key for each character until the entire word is erased.
4. Type the correct word.
5. Press **Reloc**.

## Erasing Manually in Proportional Spacing

When erasing manually, hold down **Code** while you press **Backspace** (**Bksp1**) to correctly realign the printwheel pointer at the incorrect character.

The carrier moves back one unit of space each time you hold down **Code** while you press the **Backspace** key.

1. Position the printwheel pointer at the left edge of the *last* character in the word.
  - Press **Spacebar**, **Backspace**, or hold down **Code** while you press **Backspace** (**Bksp1**).
2. Press the **Correction** key.
  - The printwheel spins.
3. Type the last character in the word just like you typed it the first time.
  - The character is erased.
  - If the incorrect character is not completely erased, hold down **Code** while you press **Backspace** (**Bksp1**) to reposition the printwheel pointer to the left edge of the incorrect character. Repeat steps 2 and 3.
4. Press the **Correction** key.
  - The printwheel spins and the carrier does not move.
5. Type the previous character in the word.
  - The carrier backs up and erases the previous character.
6. Repeat steps 4 and 5 for each character until the entire word is erased.
7. Type the correct word.

## Practice

Type the following paragraph, line by line as printed below, including the highlighted error. Do not remove the paper from your typewriter. Manually erase the incorrect word after you type the entire paragraph.

The world's first duel thiw typewriters was fought in Cincinnati, Ohio in 1883. A Cincinnatian, Louis Taub, challenged Frank McGurrian, a Salt Lake City court typist, to a contest consisting of 45 minutes of direct dictation and 45 minutes of copying. (Do not press CRtn.)

1. Press **Paper Down** twelve times to move the carrier to the line with the incorrect word (the first line).
2. Press **Spacebar**, **Backspace**, or hold down **Code** while you press **Backspace** (**Bksp1**) to position the printwheel pointer at the left edge of the *w* in *thiw* (the last incorrect character in the word).
3. Press the **Correction** key.
  - The printwheel spins.
4. Type the incorrect character (*w*).
  - The *w* is erased.
  - If the incorrect character is not completely erased, hold down **Code** while you press **Backspace** (**Bksp1**) to reposition the printwheel pointer to the left edge of the incorrect character. Repeat steps 2, 3, and 4.
5. Press the **Correction** key.
  - The printwheel spins, but the carrier does not move.
6. Type the incorrect character (*i*).
  - The carrier backs up and erases the *i*.
7. Repeat steps 5 and 6 to erase the *h* and *t*.
  - The entire incorrect word is erased.
8. Type the word *with*.

## Helpful Hints

- When erasing manually, you only need to position the printwheel pointer at the left edge of the *last character in the word*. After you erase the last character, pressing the **Correction** key and typing the previous character automatically moves the carrier and erases the previous character.
- Always erase a word from right to left, then type the correct word.
- If the incorrect character is not completely erased, hold down **Code** while you press **Backspace (Bksp1)** to reposition the printwheel pointer at the left edge of the incorrect character.
- When erasing in PS (within the correction memory), your typewriter remembers approximately the last 100 characters you type.

## Storage

Your typewriter has approximately 31,000 characters of storage. The storage capacity is equivalent to approximately 16 average letters.

The information you store is called a job. A job can be a word, line, sentence, paragraph, page or several pages. Some specific examples of a job may be a letter, will, statistical report, or the current date.

Storing jobs allows you to:

- Play back information that you use frequently; for example, names, addresses, and paragraphs in a letter.
- Play back copies of letters or other jobs without retyping the entire job.
- Make changes to your letters or documents without retyping the entire job.

Your typewriter uses batteries to save stored information when the typewriter is turned off. Keep batteries installed at all times and replace them once a year. See pages 7-12 through 7-14 in the Reference section.

**Note:** If the Store light is blinking quickly, the typewriter is searching memory. You should *not* perform any typewriter operation until the light stops blinking.

## Storing a Job

The information you store is called a job. A job can be a word, paragraph, or several pages.

**Note:** You must type a job with **ARtn** on if you want it to play back justified. See "Playing Back a Multipage Job with Justified Margin" on page 4-13.

## Opening Storage

1. Always prepare your typewriter *before* you open storage.
  - Insert paper; install the desired printwheel; set margins, tabs, and line space.
2. Press and hold down **Store** while you type the number (1 through 99) where you want to store the job.
  - You may type any number (1 through 99).
  - Always use the number 1 (one) on the top row, not the letter / to type a number.
  - The **Store** light blinks.
  - The **ARtn** light comes on.
  - The carrier returns to the left margin but the paper does not move up.
  - Underlining is turned off.
  - The printwheel spins.
3. You may begin typing when the **Store** light comes on solid.

## Typing into Storage

Type your job.

- Let the carrier return automatically at the end of each full line of typing.
- Use the **Correction** key to erase any incorrect characters, spaces, or carrier returns you notice immediately.

**Note:** You cannot use manual erase to correct errors while storing a job. You will learn how to revise a stored job later.

## Closing Storage

Press and release **Store**.

- The carrier returns to the left margin.
- The **Store** light goes off and the storage area is closed.
- The **ARtn** light stays on.
- Underlining is turned off.
- The printwheel spins.

## Practice

1. Insert paper; select the desired printwheel; set margins, tabs, and line space.

12 Pitch	or	10 Pitch
L Mar 24		L Mar 20
R Mar 74		R Mar 70

2. Store the following paragraph, leaving the **ARtn** light on.
  - Correct only the errors that you notice immediately.
3. Be sure to press **Store** to close the storage area at the end of the paragraph.

**Store + the number**

The Central School District has been granted funds to establish a Demonstration Center to serve this entire area. On behalf of our staff, I would like to extend a formal invitation to you to visit our facilities. **Store**



## Helpful Hints

- Always set margins and tabs *before* you begin storing a job.
- Always wait for the **Store** light to come on solid before you type your job.
- Do not change margins *while* storing a job.
- If you plan to change to a printwheel in a different pitch while storing a job, be sure to set the same margins and tabs for both printwheels *before* you begin storing the job.
- *Do not try to use manual erase while storing a job.* The typewriter backspaces when you press the **Correction** key outside the correction memory.
- Use the **Correction** key to erase incorrect characters or unwanted spaces and carrier returns you notice immediately.
  - You will learn how to revise a stored job later in this section.
- Always press **Store** to close storage when you finish typing a job.
- If you turn off your typewriter while storage is open, you must reopen storage and play back to the end of the job before you continue typing.
- If Underlining is on when you finish typing a job, turn it off before pressing **Store** to close storage.

## Playing Back a Stored Job

### Beginning Playback

1. Insert paper. Install the same pitch printwheel and set the same margins, tabs, and line space you used when you stored the job.
  - Be sure the **ARtn** light is on.
  - Be sure the carrier is positioned at the point you want playback to begin.
2. Press **Play** + the number where you stored the job.
3. Release the keys.
  - Playback begins immediately.

### Stopping Playback

Press any key and release it. For example, the **Spacebar**, **Play**, **Correction** key, or any key on your typewriter will stop playback immediately.

- Playback stops immediately.

### Playing Back One or More Characters

Press **Play** + **Spacebar**.

- One character prints each time you press and release the **Spacebar** while holding down **Play**.
- Characters keep printing if you hold down the **Spacebar** while you hold down **Play**.

### Continuing Playback

Press and release **Play**.

- The typewriter prints the rest of the job.

## Practice

1. Insert paper. Install the same pitch printwheel and set the same margins, tabs, and line space you used when you stored the job.
2. Play back the job you stored earlier.
  - You can play back the job as many times as you wish.
    - a. Press **CRtn** to position the carrier at the left margin.
    - b. Press **Play + the number** where you stored the job.
3. Practice starting, stopping, and playing back one character at a time.

## Helpful Hints

- If you are playing back a job and want to start from the beginning, press **CRtn** to position the carrier at the left margin, then press **Play + the number**.
- When jobs are stored in PS and played back in 10, 12, or 15 pitch, they may not play back exactly as you typed them.
- Corrections made while playing back with the **Store** light off are not corrected in the stored job. The corrections will not appear the next time you play back the job.
- A job can be played back with the **ARtn** light on or off. The **ARtn** light stays on until you turn it off.

When the **ARtn** light is on during playback:

- The typewriter automatically ends the lines according to the present margins set in the typewriter. If a word extended past the right margin when you originally typed it, it may be printed on the next line during playback.
  - If you press **CRtn** before your typewriter beeps at the right margin, the typewriter will always return at that point during playback.
- When the **ARtn** light is off during playback, your job plays back line for line as you typed it.

## Revising a Stored Job

You have just learned to play back a stored job with storage closed (**Play + the number**).

You will learn another way to play back a stored job with storage open (**Store + the number**). Storage must always be open if you want to add, remove, or correct words in a stored job.

## Adding a Word in a Stored Job

### Opening Storage

1. Insert paper. Install the same pitch printwheel and set the same margins, tabs, and line space you used when you stored the job.
2. Press **Store + the number** (1 through 99) where you stored the job.
3. Release the keys.
  - The carrier returns to the left margin.
  - The **Store** light blinks.
  - The **ARtn** light comes on.
  - Underlining is turned off.
  - The printwheel spins.
4. You may begin playback when the **Store** light comes on solid.

### Playing Back

1. Press and release **Play** to begin playback.
2. Press **Play** or any key to stop playback one or two words before the point where you want to add the word.
3. Hold down **Play** while you press and release the **Spacebar**. Play back one character at a time to reach the point where the word is to be added.
  - If you play too far, use the **Correction** key to erase the characters or play the job back again. Remember what you have erased so you can retype the characters later.

### Adding a Word

1. Type the word plus one space after it.
  - Also retype any words that you erased if you played too far.
2. Press **Play + Spacebar** to make sure the next character plays back correctly.

### Continuing Playback

Press and release **Play** to print the rest of the job or to reach the next point to add a word.

### Closing Storage

Press and release **Store**.

- The carrier returns to the left margin.
- The **Store** light goes off and storage is closed.
- The **ARln** light stays on.
- Underlining is turned off.
- The printwheel spins.

### Practice

1. Insert paper. Install the same pitch printwheel and set the same margins, tabs, and line space you used when you stored the job.
2. Press **Store + the number** where you stored the Central School District job.
  - Leave the **ARln** light on.
3. Press **Play** to play back through the space after the word *Demonstration*, then type *Training* plus a space.
  - Use the **Correction** key to erase any characters if you played too far to insert the word. Remember the characters you erased because you will have to retype them after you add the word *Training*.
4. After adding the word *Training*, press **Play + Spacebar** to make sure the next character plays back correctly.
  - When you add a word to a job, the words in storage move over as you add the information. You are not typing over anything.
5. Press **Play** to play back the remainder of the job.
6. Always end a job by pressing **Store**.
  - This closes the storage area.

#### Store + the number

The Central School District has been granted funds to establish a Demonstration Center to serve this entire area. On behalf of our staff, I would like to extend a formal invitation to you to visit our facilities. **Store**

## Removing A Word In a Stored Job

### Opening Storage

1. Insert paper. Install the same pitch printwheel and set the same margins, tabs, and line space you used when you stored the job.
2. Press **Store** + the number where you stored the job.
3. Release the keys.
  - The carrier returns to the left margin.
  - The **Store** light blinks.
  - The **ARtn** light comes on.
  - Underlining is turned off.
  - The printwheel spins.
4. You may begin playback when the **Store** light comes on solid.

### Playing Back

1. Press and release **Play** to begin playback.
2. Press and release **Play** or any key to stop playback one or two words before the point where the word is to be removed.
3. Press and hold down **Play** while you press and release the **Spacebar** until the last character in the word and the space you want to remove prints on your paper.

### Removing a Word

1. Press the **Correction** key to erase the word and the space following the word from your paper.
  - The word is automatically being erased from storage and your paper at the same time.
2. Press **Play** + **Spacebar** to make sure the next character plays back correctly.

### Continuing Playback

Press and release **Play** to print the rest of the job or to reach the next point to remove a word.

### Closing Storage

Press and release **Store**.

- The carrier returns to the left margin.
- The **Store** light goes off and storage is closed. The **ARtn** light stays on.
- Underlining is turned off.
- The printwheel spins.

## Practice

1. Insert paper. Select the same pitch printwheel and set the same margins, tabs, and line space you used when you stored the job.
  - See if your line endings match the printed copy below. If not, mark the changes on your copy.
2. Press **Store** + the number where you stored the Central School District job.
  - Leave the **ARln** light on.
3. Press **Play** to play back through the space after the word *Training*.
4. Press the **Correction** key to erase the word *Training* and the space after it. (The space is erased first.)
5. Press **Play** to play back the rest of the document.
6. Remember, press **Store** to end the job and close storage.

**Store** + the number

**Play**

The Central School District has been granted funds to establish a Demonstration Training Center to serve this entire area. On behalf of our staff, I would like to extend a formal invitation to you to visit our facilities. **Store**

## Helpful Hints

- Be sure the **Store** light is on solid when adding or removing a word from a stored job.
- Use the **Correction** key to remove unwanted tabs, carrier returns, and spaces from a stored job.
- If you play into the next line, press the **Correction** key to erase back to the previous line or play the job back again. Remember what you erase so that you can retype the characters later.

## Replacing a Word in a Stored Job

### Opening Storage

1. Insert paper. Install the same pitch printwheel and set the same margins, tabs, and line space you used when you stored the job.
2. Press **Store** + the number where you stored the job.
3. Release the keys.
  - The carrier returns to the left margin.
  - The **Store** light blinks.
  - The **ARln** light comes on.
  - Underlining is turned off.
  - The printwheel spins.
4. You may begin playback when the **Store** light comes on solid.

### Playing Back

1. Press and release **Play** to begin playback.
2. Press and release **Play** or any key to stop playback one or two words before the point where the word is to be replaced.
3. Press and hold down **Play** while you press and release the **Spacebar** until the last character in the word and the space you want to replace prints on your paper.

### Replacing a Word

1. Press the **Correction** key to erase the word and the space following the word from your paper.
  - The word is automatically erased from storage and your paper at the same time.
2. Type the new word plus a space.
3. Press **Play** + **Spacebar** to make sure the next character plays back correctly.

### Continuing Playback

Press and release **Play** to print the rest of the job or to reach the next point to replace a word.

### Closing Storage

Press and release **Store**.

- The carrier returns to the left margin.
- The **Store** light goes off and storage is closed.
- The **ARtn** light stays on.
- Underlining is turned off.
- The printwheel spins.

### Practice

1. Insert paper. Install the same pitch printwheel and set the same margins, tabs, and line space you used when you stored the job.
2. Press **Store** + the number where you stored the Central School District job.
  - See if your line endings match the sample below. If not, mark the changes on your copy.
3. Press **Play** to play back through the space after the word *formal*.
4. Press the **Correction** key to erase the word *formal* and the space after it. (The space is erased first.)
5. Type the word *personal* plus a space.
  - Press **Play** + **Spacebar** to be sure the next character plays back correctly.
6. Press **Play** to play back the remainder of the job.
7. Press **Store** to close storage.

**Store** + the number

**Play**

The Central School District has been granted funds to establish a Demonstration Center to service this entire area. On behalf of our staff, I would like to extend a formal invitation to you to visit our facilities. **Store**

## Stop Code

A stop code in a job automatically stops playback. Use a stop code when you want to:

- Type variable information; for example, the date or inside address in a repetitive letter.
- Indicate the end of a page.
- Change the line space setting.
- Change keyboards.
- Change the printwheel.
  - Remember, if you change to a printwheel with a different pitch, you must set your margins and tabs for both pitches before opening storage.

As you type the job, hold down **Code** while you press **9 (Stop)** at the point where you want the typewriter to stop during playback.

- Nothing prints on your paper.

## Continuing Playback after a Stop Code

Press **Play**.

- Playback continues to the next stop code or to the end of the job.

## Erasing a Stop Code

1. Press **Store +** the number of the job with the stop codes.
2. Press **Play**.
3. When the typewriter stops during playback, press the **Correction** key.
  - The printwheel spins.
4. Press **Store** to close the storage area, or press **Play** to continue playing back and erasing stop codes.

## Helpful Hints

- To change the printwheel at a stop code:
  1. Remove the printwheel.
  2. Install the desired printwheel.
  3. Press and release **Code**.
    - If the printwheel is a different pitch, the carrier moves adjust for the pitch change.
    - Be sure to press **Code**, then make any print position adjustments by pressing **Spacebar**, **Backspace**, or holding down **Code** while you press **Backspace (Bksp 1)**.
  4. Continue typing or playing back.
- If you want to change the printwheel while storing centered headings, type a stop code at the point to change the printwheel.

### Example

Code + C  
Code + 9  
Code + 9  
Code + C  
IBM "Wheelwriter" Typewriter

- When you hold down **Code** while you press **C** to print the centered heading, be sure to change the printwheel when the typewriter stops.
  - Press **Play**.
- If you are storing jobs using an alternate keyboard, type a stop code at the point where you want to change the keyboard and printwheel.
  - Be sure to press **Code**, then make any print position adjustments by pressing **Spacebar**, **Backspace**, or holding down **Code** while you press **Backspace (Bksp 1)**.
  - Be sure the alternate keyboard and the printwheel you select have the same ID numbers.
- If you use stop codes to add variable information, use **ARtn** when you store the job.
- When storing a multipage job in one storage area, use carrier return followed by a stop code at the end of each page to allow you to easily remove and insert paper during playback. (You may prefer to store each page in a separate storage area). When using stop codes to separate pages in a multipage job, use the paper release lever to remove each page while storage is open. This prevents storing unwanted paper movements at the bottom of each page.

## Multipage Jobs

You can store multipage jobs using two different methods. You can store the job in one storage area and type a stop code (**Code + 9**) at the end of each page. You can also store each page in a separate storage area.

### Storing a Multipage Job with Stop Codes

1. Press **Store +** the number where you want to store the job.
2. Type the job using **A Rtn**.
3. Type all the pages into one storage area.
4. Press **CRtn** and then type a stop code (**Code + 9**) at the end of the text for each page.
5. Insert a new page. Use the paper bail lever for this. *Do not use Paper Up and Paper Down.*
6. Continue using **CRtn** and a stop code at the end of the text for each page.

### Storing a Multipage Job in Separate Storage Areas

1. Press **Store +** the number where you want to store a page of the job.
2. Type one page.
3. Press **Store** to close storage.
4. Remove the completed page and insert a new one.
5. Continue typing the job by repeating steps 1 through 4.

## Playing Back a Multipage Job with Stop Codes

If you have made no revisions affecting page length, play back the document.

- Playback stops at the **Stop Code** at the end of each page so you can insert a new sheet of paper.
- To resume playback, press **Play**.

If your revisions result in the stop code appearing before the end of the page:

1. Press **Store +** the number where you have the job.
2. Play back until the typewriter stops.
3. Press the **Correction** key once to erase the stop code.
4. Continue playback until you reach the desired end of the page.
5. Press **CRtn**, then hold down **Code** while you press **9** at the end of the first page.
6. Insert the next sheet of paper and continue using steps 2 through 5 to change any other stop codes.

If your revisions move the stop code to the second page:

1. Press **Store +** the number where you have the job.
2. Stop playback where the first page should end.
3. Press **CRtn**, then hold down **Code** while you press **9** at the end of the first page.
4. Insert the next sheet of paper.
5. Continue playback until you reach the original stop code.
6. Press the **Correction** key to erase the stop code.
7. Continue playing and repeat steps 2 through 5 to change any other stop codes.

## Helpful Hints

*Do not store footnotes, page headings, or page numbers with the job since revisions may cause page endings to change.*



## Hyphens at the Right Margin

A syllable hyphen is used to divide a word that is too long at the right margin.

Syllable Hyphen

Our credit department has reviewed your application.

If the hyphenated word does not fall at the right margin during playback, the hyphen will be automatically dropped.

Some hyphens are permanent parts of words; they must always be there. Permanent hyphens followed by a carrier return or an automatic carrier return must be coded. Otherwise, they may be treated as a syllable hyphen and dropped when played back with ARtn on. Look at the following example.

Permanent Hyphen  
(Code + -)

Enclosed is your new credit card No. 567-345-6501 to replace your stolen card.

### Typing a Syllable Hyphen

1. When you hear the beep at the right margin, type the first part of the word plus the hyphen (-).
2. Press **CRtn** to return the carrier.
3. Finish typing the word on the next line.

### Typing a Permanent Hyphen

1. When you hear the beep at the right margin, type the word or characters up to the permanent hyphen.
2. Hold down **Code** while you type the permanent hyphen (-).
3. Press **CRtn** to return the carrier.
4. Finish typing the word on the next line.

## Practice

1. Insert paper; install the desired printwheel; set margins, tabs, and line space.

12 Pitch	or	10 Pitch
L Mar 24		L Mar 20
R Mar 72		R Mar 65

2. Store the paragraph printed below with **ARtn** on.
  - Press **CRtn** only where marked.
  - Hold down **Code** while you press - where marked.
3. Play back the job using the same margins you used when you stored it.
4. Change the right margin to 60 and play back the job a second time with **ARtn** on.
  - The line endings will change.

Code + -, CRtn

Enclosed is your new credit card No. 567-345-0657 to replace card No. 222-345-657. **CRtn**

**CRtn**  
Our credit department has reviewed your application and is increasing your line of credit to \$2,500. **CRtn**  
**Store**

## Helpful Hints

- Use syllable hyphens to divide words that are too long to be typed at the right margin.
- Permanent hyphens or dashes are typed in different styles (for example, two hyphens or space/hyphen/space). Just remember that whatever style you use, the permanent hyphen or dash must be used when it is at the end of a line.

---

## Storage Helpful Hints

### While Storing a Job

- Always wait until the **Store** light comes on solid before you begin typing your job.
- Always remember to close storage (press **Store**) after storing a job.
- Use the **Correction** key to erase unwanted tabs, carrier returns, and spaces.
- Always turn Underlining off before pressing **Store** to end a job.

### Storing a Job with Underlining

- Always store the underlines while you are typing and storing the job. If a job is stored with Underline off and is played back with Underline on, the underlines in the job may not play back as desired.
- Always turn Underlining off before pressing **Store** to end a job.

### Correcting Errors with Storage Open

- Do not attempt to erase farther back than approximately 200 characters (100 in PS).
- If the **Correction** key backspaces but does not erase:
  1. Press **Store** + the number, then press **Play**.
  2. Stop playback when the incorrect character prints. *Do not play back beyond the incorrect character.*
  3. Press the **Correction** key.

- Whenever possible, make corrections by using the **Correction** key to erase back from the point where you stopped typing or playing back.

Two types of corrections must be made by using the **Correction** key to erase back from where you stopped typing or playing back:

1. Erasing extra characters or words. (Otherwise, spaces play back where the extra characters or words were erased.)
2. Correcting words in PS. (Otherwise, playback with Automatic Carrier Return on may not be satisfactory. Spaces following the corrected words may not change to carrier returns near the right margin.)

Many other corrections may be made without using the **Correction** key to erase back from the point where you stopped typing or playing back. However, after making the correction, *you must reposition the carrier at the point where you stopped typing or playing back.* Otherwise, when you continue typing or playing back, you may create overstrikes on your paper and in storage.

### While Playing Back a Stored Job

When complex jobs are stored in PS and played back in 10, 12, or 15 pitch, they may not play back exactly as you typed them. For example, characters and underlines may not be spaced properly.

## While Storing an Indented Job

When storing an indented job (the **Store** light is on), you should set tabs for each temporary left margin *before* you begin typing.

- Be sure to make all corrections in storage before setting or clearing a temporary left margin.
- To correct errors when storing a job with indented lines, do not backspace beyond the temporary left margin to correct errors. Finish typing the job, then correct the errors during playback.

To store an indented job:

1. Set tabs for each temporary left margin before you begin typing.
2. Type until you reach the first indented line.
3. Type any characters to the left of the temporary left margin (for example, a number or letter when typing indented outlines).
4. Press the **Tab** key to move to the temporary left margin.
5. Hold down **Code** while you press **Tab** (**indent**) to set the temporary left margin.
6. Type the indented lines.
7. When you finish typing the indented lines, hold down **Code** while you press **CRtn** (**InC/r**).

## While Revising a Job

- When revising complex jobs, be sure to play back and make revisions in the same pitch used to store the job, especially if job was stored in **PS**.
- Always open storage before making a revision.
  - The **Store** light must be on.
- Always close storage after you finish revising the job by press **Store**.
  - The **Store** light goes off.
- Pressing **Store** + the number (1 through 99) always opens storage at the beginning of a job.
- If you play back too far or want to start over:
  1. Press **Play** to stop playback.
  2. Press **Store** + the number (1 through 99).
  3. Press **Play**. (Playback starts again at the beginning of the job.)
- Use the **Correction** key to erase unwanted carrier returns from stored job:
  1. Press **Play** or **Play** + **Spacebar** until the carrier return play back.
  2. Press the **Correction** key.
- After making a revision, hold down **Play** while you press and release the **Spacebar** several times to make sure the next few characters play back correctly.
- When revising indented jobs, be sure to stop playback at the word or character you want to revise. Remember, *you cannot use the Correction key to erase characters typed before you press Code + Tab or Code + CRtn*. Therefore, if you play back too far, you may need to start playing back again from the beginning of the job.

---

## Deleting Storage

### Deleting a Storage Area

1. Press and hold down **Del** while you type the number of the storage area you want to delete.
2. Release the keys.
  - The printwheel spins.
  - The storage area is deleted.

### Deleting the Last Part of a Job

You can delete the last part of a job without deleting the entire job.

1. Press **Store** + the number where you stored the job.
2. Press **Play** to play back the portion of the job you want to save.
3. Press **Play** or any key to stop playback.
4. Press and release **Del** + 0 (zero).
  - The printwheel spins.
  - The remainder of the job is deleted.
5. Continue typing or press **Store** to close storage.

### Deleting All Storage Areas

1. Hold down **Code** and **Shift** while you press **Del**.
2. Release the keys.
  - The printwheel spins.
  - All storage areas are deleted.

### Canceling Delete

If you press **Del** by mistake, you can cancel it.

1. Do not release **Del**.
2. While holding down **Del**, type a number larger than 100.
3. Release the keys.
  - Nothing is deleted.

---

## Storage Full Warning

The storage capacity of your typewriter has a set limit of characters. Therefore, each job you store subtracts from the available capacity.

When your typewriter beeps three times, while the **Store** light blinks slowly, you have space for approximately 90 characters.

- Do not continue typing.
- You must make more space available.

**Note:** If you are using a PS printwheel, you have space available for approximately 30 characters.

## Making Space Available in Storage

1. Do not press **Store** to close the present storage area.
2. Decide which storage area you want to delete (a job you no longer need).
3. Press **Del** + the number of the storage area you want to delete.
  - The printwheel spins.
  - You may need to delete one or more storage areas until the **Store** light stops blinking.
  - The present storage area stays open.
4. Continue typing.

If you do not want to delete a storage area:

1. Press **Store** to close the storage area.
  - You must position the carrier at the last character you typed.
2. Continue typing. (Your typing *will not* be stored.)

## Storage Full

If you ignore the warning and type until storage is full:

- All keybuttons become inoperative except **Del** and **Store**.
- The typewriter beeps each time you press a keybutton, but no characters print on your paper.
- Nothing else can fit into storage.
- You must delete one or more storage areas or close storage.

## Storage Log

Because your typewriter can store information in many storage areas, you need to keep a record of what you stored and where you stored it.

## Finding Your Stored Information

1. Write down the number of the storage area on the job itself.
2. Use a log to keep track of what you store. See the sample log below.

Storage Area	Description Of Job	Printwheel Pitch	Margins	Tabs	Line Space
1	Form Letter	12	18-90	51	1
2	Current Date	12	—	—	1
3	Thank You Letter	PS	18-90	—	1
4	Will	10	15-75	20, 42	2

The next page has a blank storage log. If you wish, copy and use this log for your own work.

## Storage Log

Storage Area	Description of Job	Printwheel Pitch	Margins	Tabs	Line Space

## Repetitive Letters

A repetitive letter is the same letter sent to several different people. On your typewriter, you have to type the repetitive letter only once.

### Storing a Repetitive Letter Using Stop Codes

1. Insert paper; install the desired printwheel; set margins, tabs, and line space.
2. Press **Store** + the number where you want to store the letter.
  - The **Store** light blinks.
3. When the **Store** light comes on solid, type the repetitive letter placing stop codes (**Code** + **9**) wherever variable information is to appear.
4. Press **Store** to close storage.

In the example on the next page, the variable information, such as name, address, salutation, and additional information in the body of the letter, is shaded ( ). When you type the letter, hold down **Code** while you press **9** (**Stop**) where the address, name, and other variable information appear.

## Playing Back a Repetitive Letter

1. Make sure the **Store** light is off.
2. Press **Play** + the number (1 through 99) where the repetitive letter is stored.
3. When playback stops at a stop code, type the variable information.
4. Press **Play** to continue playback.

### Example of a Repetitive Letter:

April 23, 1984

6 CRtns

Code + 9

Inside Address

2 CRtns

Dear Code + 9 (Mr. Name):

2 CRtns

Thank you for ordering an IBM typewriter. Your new typewriter will be delivered {Date}. Please call me if you have any questions.

Code + 9

Cordially yours,

Paul Boler  
Sales Manager

Store

## Practice

To store the repetitive letter printed on page 3-32:

1. Insert paper; install the desired printwheel; set margins, tabs, and line space.

12 Pitch

or

10 Pitch

L Mar 24

L Mar 20

R Mar 60

R Mar 65

2. Press **Store** + the number where you want to store the repetitive letter.
  - The **Store** light blinks.
3. When the **Store** light comes on solid, type the date and press **CRtn** six times.
4. Hold down **Code** while you press 9.
  - The printwheel spins.
  - Do not press **CRtn** to leave space for the inside address.
5. Press **CRtn** two times.
6. Type *Dear* plus one space, then hold down **Code** while you press 9.
  - Do not space after the stop code.
7. Type a colon (:), then press **CRtn** two times.
8. Type the rest of the letter up to the word *delivered*.
9. Type *delivered*. Press **Spacebar**, then hold down **Code** while you press 9. (Do not space.) Type a period (.) and space two times.
10. Type the rest of the letter and press **Store** to close the storage area.

## Practice (continued)

To play back the repetitive letter you stored:

1. Insert paper. Install the same pitch printwheel and set the same margins, tabs, and line space you used when you stored the repetitive letter.
2. Press **Play +** the number where you stored the letter.
  - Leave the **ARtn** light on.
  - The **Store** light will be off; storage is closed.
  - Playback will stop when a stop code is reached.
3. When playback stops, type the inside address:

*Mr. A. L. Black*(Press **CRtn**)  
*1708 Sunset Boulevard*(Press **CRtn**)  
*Lexington, KY 40502*(Do not press **CRtn**)

4. Press and release **Play**.
5. When playback stops, type: *Mr. Black* (the salutation). Do not press **Spacebar**.
6. Press and release **Play** to play back to the next stop code.
7. Type: *June 21, 1984* (the date). Do not press **Spacebar**.
8. Press and release **Play** to play back the rest of the letter.

## Optional Practice

Repeat the steps on the above page and print the next letter using the variable information below. (Press **CRtn** only where marked.)

*Ms. Diane Moore***CRtn**  
*809 Sun Valley Lane***CRtn**  
*Lexington, KY 40509*

*Ms. Moore*

*June 25, 1984*

## Combining Stored Jobs

After you have stored each job in a separate storage area, you can combine those jobs into one job by playing each job into another storage area. For example, paragraphs stored as separate jobs can be combined to create a repetitive letter.

## Storing Jobs In Separate Storage Areas

1. Insert paper. Install desired printwheel and set margins, tabs, and line space.

<b>12 Pitch</b>	or	<b>10 Pitch</b>
L Mar 24		L Mar 20
R Mar 60		R Mar 65

2. Press and hold down **Store +** the number where you want to store the job, then release the keys.
  - The **Store** light blinks.
3. You may begin typing the job when the **Store** light comes on solid.
4. Press **CRtn** two times or as many times as necessary at the end of each job.
5. Press and release **Store** to close the storage area.
6. Repeat steps 2 through 5 until each job has been stored in a separate storage area.





## Practice

Store each of the following jobs in a separate storage area. If the storage areas you choose are different from the job numbers printed below, write the numbers you use on your copy.

### (Job 3)

Store + the number (1 through 99)  
October 15, 1984CRtn  
CRtn  
CRtn  
CRtn  
CRtn Store

### (Job 4)

Store + the number (1 through 99)  
Mr. Robert W. TorezCRtn  
500 Laketower DriveCRtn  
Lexington, KY 40502CRtn CRtn Store

### (Job 5)

Store + the number (1 through 99)  
Ms. Diane MooreCRtn  
809 Sun Valley LaneCRtn  
Lexington, KY 40509CRtn CRtn Store

### (Job 6)

Store + the number (1 through 99)  
Thank you for your recent  
order. CRtn CRtn Store

### (Job 7)

Store + the number (1 through 99)  
Thank you for your recent  
order. We are pleased to  
welcome you as a new  
customer. CRtn CRtn Store

### (Job 8)

Store + the number (1 through 99)  
Your order has been processed, and  
will be shipped in approximately  
ten days. CRtn CRtn Store

### (Job 8)

Store + the number (1 through 99)  
Sincerely, CRtn  
CRtn  
CRtn  
CRtn  
Sharon R. GallagherCRtn  
New Account ManagerCRtn CRtn Store

## Practice

Using the jobs you just stored, practice combining the jobs to create two jobs in separate storage areas.

You will combine jobs 3, 4, 6, 8, and 9 to create one job. You will combine jobs 3, 5, 7, 8, and 9 to create another job.

1. Insert paper. Install the same pitch printwheel and set the margins, tabs, and line space you used when you stored the job.
2. Press Store + the number of an unused storage area; release the keys.
3. Press Play + the number where you stored job 3; release the keys.
  - The job will play into the new storage area.
4. When playback stops, press and hold down Play + the number where you stored job 4; release the keys.
  - The job will play into the new storage area.
5. When playback stops, type:

Dear Mr. Torez: CRtn CRtn

6. Press Play + the number where you stored job 6; release the keys.
  - The job will play into the new storage area.
7. When playback stops, press Play + the number where you stored job 8.
  - The job will play into the new storage area.
8. When playback stops, press Play + the number where you stored job 9.
9. Press and release Store.

## Optional Practice

Repeat steps 1 through 9 to combine the following jobs: 3, 5, 7, 8, and 9.

- When you reach step 5, type:

*Ms. Moore:CRtn CRtn*

**Note:** Delete these two letters. You no longer need them.

## Addressing Envelopes

### Practice

1. Insert an envelope.
2. Set the left margin at the point where you want printing to begin.
3. Turn Automatic Carrier Return (ARtn) off.
4. Press **Play** + the number where you stored job 4. See page 3-36.
5. Release the keys when playback starts.
6. When playback stops, remove the envelope.
7. Insert another envelope.
8. Press **Play** + the number where you stored job 5. See page 3-36.
9. Release the keys when playback starts.
10. When playback stops, remove the envelope.

---

## Advanced Storage

This section contains instructions for *Directory*, *Mark*, *Justification*, *Format Storage*, and *Advanced Revision*. They allow you to better manage many different kinds of jobs in storage.

**Note:** If the **Store** light is blinking quickly, the typewriter is searching memory. You should *not* perform any typewriter operation until the light stops blinking.

## Directory

The typewriter remembers and keeps a list of jobs that have been stored in different storage areas. We call this a *directory*.

Because the typewriter keeps track of used storage areas, you do not have to do so. To get a list of the storage areas that have been used, you play the directory.

### Playing the Entire Directory

1. Be sure the **Store** light is off.
2. Insert paper into the typewriter.
3. Hold down **Code** while you press **D (Dir)**.
4. Release the keys.

The directory looks similar to this:

```
          5237
1 The Central School district. . .
2 Enclosed is your. . .
52 This is the time. . .
```

The first line of numbers tells you the approximate number of characters available in storage.

The additional lines tell you the number of each used storage area plus the first 40 characters in each area.

### Playing Part of the Directory

1. Be sure the **Store** light is off.
2. Insert paper into the typewriter.
3. Hold down **Code** while you press **D (Dir)** and the number of the storage area you want the directory to start with.
4. Release the keys.
  - The directory lists the storage areas beginning with the specific number you typed.
  - The directory prints the first 40 characters in each storage area.

### Helpful Hints

- The directory may not print out correctly if the printwheel you are using is a different language than the one used to store the information.
- You can stop play out of the directory by pressing any key.
- Overstrikes in a storage area will be printed as separate characters when you play the directory.
- Underline mode is ignored when you play the directory.
- When memory is full, the total number of characters available in storage will be zero (0).
- Tabs, carrier returns, and indexes are shown as spaces.

## Mark

### Using Mark for Preprinted Forms

If you have used a typewriter to fill in preprinted forms, you may remember how you had to align the carrier to print in each box. If you had to type the same form many times, this typing job could become time-consuming.

The mark function (**Shift + Code + M**) helps you automatically type preprinted forms. Typing forms is a two-step process: First, you store a layout of the form using the mark function. Second, you play back the form and fill in the blanks.

A mark (**Shift + Code + M**) identifies a point on the form where the text is inserted or needs to print.

See the sample form on the next page:

- Each *M* shows where you type a mark. A mark includes an automatic stop code. During playback the typewriter moves to the mark and stops for you to type variable information. *Variable information is text that changes for each form.*
- Each *MC* shows where you type a mark and then press the **Correction** key to erase the automatic stop code. After you erase the stop code, you type the constant information. *Constant information is text that is the same for each form.* See examples of constant information in the shaded boxes (MC).

### A Sample Form

Make copies of this form to use in the practice on the following page.

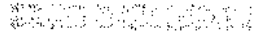
Newspaper Subscription Service				
Contributors List				
First Name	M.I.	Last Name	Contribution A	
M	M	M	M	
Address			Date of Contri	
M			M	
City	State	Zip	ID Number	
M	M	M	M	
Telephone No.				
M				
Distribute to: Accounting Publishing Direct Mail				
<u>MC</u>  Route Manager				
<u>MC</u>  Newspaper				

## Storing a Form Layout

1. Insert a blank form using the paper bail load lever.
2. Do not use the **Paper Up**, **Paper Down**, or **CRtn** keys to move the form before completing step 5.
3. Set your *left margin* at the *left edge* of the paper.
4. Hold down **Store** and press the number of the storage area you want to open.
  - The **Store** light blinks.
5. Hold down **Code** while you press **R** to turn automatic carrier return off.
6. Type the form layout as follows:
  - a. Move the carrier to the first point on the form where variable or constant information needs to print. Use any of these keys:
    - Paper movement keys (**Paper Up**, **Paper Down**, **Micro Up**, and **Micro Down**)
    - **CRtn** (**Carrier Return**)
    - **Spacebar**
    - **Backspace**
    - **Code + Backspace** (**Bksp 1**)
    - **Tab**
    - **Code + Reloc** (**MRtn**)
  - b. Press **Shift + Code + M** (**Mark**) at each point where *variable information* is to appear.
  - c. At each point where *constant information* is to appear, press **Shift + Code + M**. Then press the **Correction** key and type the *constant information*.
    - When you press the **Correction** key, the automatic stop code is erased. During playback, the typewriter will print the *constant information* without stopping.
7. Repeat step 6 for each point until you finish the form.
8. Press **Store** to close storage when you finish typing the form layout.

## Helpful Hints

- Marks do not have to be inserted in any particular order. For example, you may move the paper down to a previous line and insert a mark. However, the marks will play back in the order they were entered.
- If you are entering a form layout for a multipage form, you should store the layout for each page in a separate storage area.
- Always wait until the **Store** light comes on solid before you enter a form layout.
- The mark does not print on your paper.
- The typewriter clears the correction memory after every mark.
- The typewriter does not accept marks during decimal tab or centering operations.

## Playing Back the Form Layout

1. Insert a blank form using the paper load lever.
2. Do not use the **Paper Up** or **Paper Down**, or **CRtn** keys to move the form before completing step 5.
3. Set your *left margin* at the *left edge* of the paper.
4. If **ARtn** is on, turn it off.
5. Hold down **Play** and press the number of the storage area where you stored the form layout.
  - The typewriter moves to the first mark point and stops.
6. When the typewriter stops, type the *variable information*.
7. The typewriter will print the *constant information* without stopping.
  - If the typewriter stops at the *constant information*, you did not erase the stop code when you stored the form layout.
8. Press **Play** to continue playback.
9. Repeat steps 6, 7, and 8 until you finish playing back the form.

## Helpful Hints

- Make sure the **Store** light is off during playback, or the original stored form you typed will be modified.
- Because you are playing back the form with storage *closed*, the new text is *not* being stored with the form layout.
- The correction area is cleared each time you type or play a mark. Therefore, you must use manual erase to correct errors made before the current mark.
- To correct a form layout, delete the storage area and retype the form.

## Practice

Make a copy of the sample form (see "A Sample Form" on page 4-5), or use a form from your business or home. Follow the steps beginning on page 4-6 to practice storing and playing back the layout.

Type a route manager and a newspaper name beside the two MCs.

## Justification

So far, you have played back jobs with an uneven right margin or a *ragged* right margin. However, you can automatically play back a job with an even or *justified* right margin.

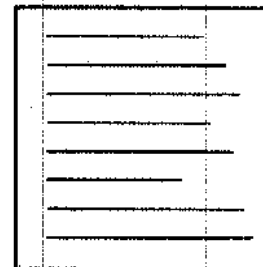

Ragged Right  
Margin

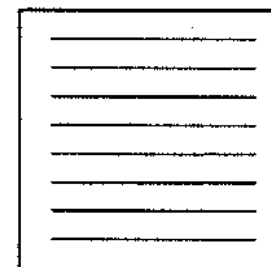

Justified  
Margin

### Typing a Job to Be Justified

1. Press **Store** + the number where you want to store the job.
2. Type the job using **ARtn**.
3. Press **CRtn** for lines that end *before* the right margin beeps and should not be justified.
4. Hold down **Code** while you press **CRtn** for lines which end *after* the right margin beeps and should not be justified.
5. Hold down **Code** while you press **Spacebar** or **Hyphen** between each word you want to keep together during playback. This will prevent the following:

```

truly yours,      Very
                  Bruce
A. Savage
                  Engineering
Products Manager
  
```

Be sure to type them like this:

```

Code + Spacebar
|
Very truly yours,
Code + Spacebar
|
Bruce A. Savage
Engineering-Products Manager
Code + Hyphen   Code + Spacebar
  
```

### Playing Back a Job with Justified Margin

1. Make sure the **Store** light is off.
2. Set the right margin where you want it.
3. Hold down **Code** while you press **Justify** and type the number of the storage area you want to play back.
  - The typewriter begins to play back the job with a justified right margin.

### Stopping Justified Playback

Justified playback stops when:

- You press any key.
- The typewriter comes to a stop code.
- The typewriter reaches the end of a job.

### Resuming Justified Playback

Hold down **Code** while you press **Justify**.

- The typewriter plays back the remainder of the job with a justified right margin.

### Practice

1. Set the following margins:  
 LMar 10 RMar 75
2. Play back a justified copy of any job you have stored using **ARtn**.



## Justifying Parts of a Job

Sometimes you may need to justify part of a job. For example, you may have a paragraph that you want to play back justified, even though the rest of the job is not justified.

## Storing the Job

When you store the paragraph, type a stop code (**Code + 9**) before and after the justified part of the paragraph.

## Playing Back the Job

1. Hold down **Play** and type the number where the job is stored.
  - The job begins to play back.
2. Hold down **Code** while you press **Justify** when the typewriter reaches the stop code.
  - The typewriter plays back the justified part of the job and stops at the stop code.
3. Press **Play** when the typewriter reaches the second stop code.
  - The job continues to play back.

## Multipage Jobs

It is important to read this section before typing a multipage job that will be justified.

### Typing a Multipage Job to be Justified

1. Press **Store +** the number where you want to store the job.
2. Type the job using **ARIn**.
3. Type all the pages into one storage area.
4. Press **CRIn** and then type a stop code (**Code + 9**) at the end of the text for each page.
5. Insert a new page. Use the paper bail lever for this. *Do not use Paper Up and Paper Down.*
6. Continue using a **CRIn** and a stop code at the end of the text for each page.

### Playing Back a Multipage Job with Justified Margin

1. Make sure the **Store** light is off.
2. Set the right margin where you want it.
3. Hold down **Code** while you press **Justify** and type the number of the storage area you want to play back.
  - The typewriter begins to play back the job with a justified right margin.
4. Insert a new page using the paper bail load lever at each stop code indicating end of page. Hold down **Code** while you press **Justify** to continue justifying.

#### Notes:

1. The justifying process causes most jobs to "grow" or become longer. A full page of text might become 1 to 3 lines longer when justified. Because of this, you might leave 2 or 3 extra lines at the end of each page when storing the job. If your page still ends too close to the bottom, you can stop playback anywhere on the line that you want to be the last line. Then press **Code + Justify + E (Line)** to print enough additional text to complete the line. (Also see "Storing a Multipage Job with Stop Codes" on page 3-18.)
2. To justify one page of a multipage job, you first copy the entire job into another storage area and then delete the parts you do not need. (See "Copying a Job Into Another Storage Area" on page 4-32.)

#### Completing the Last Line of Each Page of a Multipage Job

When you play back a justified multipage job, the last line of any page may not be played to the right margin. You will need to print text from the next page to complete the line.

1. Hold down **Code** while you press **Justify** and **E (Line)** after you reach a page end stop code.
  - The typewriter prints enough text to fill in the last line of the page.
2. Insert a new page.
3. Hold down **Code** while you press **Justify**.
  - The typewriter resumes playback.

## Helpful Hints

- The typewriter only justifies jobs which were typed into storage using **ARIn**.
- The typewriter justifies to the right margin. For example, if the right margin is set at 70, the typewriter justifies the lines at 70.
- Storage must be off to play back a justified job.
- When you play back a justified copy, the typewriter changes the line endings only on your paper. The storage area remains unchanged.
- The following items can be part of a job and will not be justified:
  - centered text
  - decimal tab text
  - any line that you typed with a carrier return before the right margin beep (for example, the short last line of a paragraph).
- The following items will not justify, and they should not be used in a justified job:
  - any movements made with the **Paper Up** and **Paper Down** keys
  - lines that contain stop codes for variable information
  - lines that contain text with more than two spaces between words
  - mark (**Shift + Code + M**)
  - manual underline
  - double underline
  - pitch change.
- *Do not store* footnotes, page headings or page numbers with the job since revisions may cause page endings to change.
- If you have forgotten to underscore text that is to be justified, you must reopen the storage area and use the **Advnc + To** or **Play** to get to the first word to be underscored. Then turn underscore on and play through the text to be underscored. *Do not* move backward to underscore text.

## Format Storage

Letters, reports, addresses for envelopes and many other things that you type require different margin and tab settings. The margin and tab settings for a job are called the *format* for the job.

The formats that you use frequently can be saved in Format Storage. Then, when you want to use a particular format, you recall it from storage. Recalling a format causes those margins and tabs to be automatically reset for you, saving you the time for doing this. Saving formats is very similar to storing jobs.

You can save up to eight formats in Format Storage.

## Saving Format Settings

1. Set the margins and tabs where you want them.
2. Hold down **Code** while pressing and releasing **P (SavFm) + the number (1 through 8)**.
  - The printwheel spins.
  - The current margins and tabs are saved in the format storage area you selected.

**Note:** To change a stored format, set the new margins and tabs and save them as described above.

## Using Format Settings

1. Insert the correct printwheel before using a format.
2. Hold down **Code** while pressing and releasing **O (UseFm) + the number (1 through 8)**.
  - The printwheel spins.
  - The margins and tabs in the current pitch are set to the format you just recalled.
  - The carrier will move to the new left margin.
  - A stop code is automatically inserted in your text.
  - Indent (temporary left margin) is automatically cleared.

**Note:** If the format storage area is empty, the printwheel does not spin and nothing is changed.

## Helpful Hints

- During playback the automatic stop code(s) will remind you to recall the stored format(s).
- Formats cannot be deleted. Instead, set the new margins and tabs you want and save them in an area that you no longer need. Saving the new format replaces the old format setting.
- Always install the printwheel for the job you are going to type before opening storage.
- Always recall your format before playing back a job since a format is not saved with a job.
- Be sure you insert the correct printwheel before recalling a format. *Do not* recall a format and then change printwheels.

## Practice

1. Using the instructions for "Saving Format Settings" on page 4-17, set the following margins and tabs and save them in format storage areas 1 and 2:

**Format Area 1**  
Left margin 12  
Right margin 65  
Tabs 17

**Format Area 2**  
Left margin 25  
Right margin 50  
No tabs

2. Hold down **Code** while pressing and releasing **O (UseFm) + 1**.
3. Hold down **Store** and press the number of the storage area you want to open. Type the following paragraph.

When typing a manuscript for a dissertation, you may need to change margins or tabs for a reference in the middle of the text so that the reference will be indented on both sides.

4. Hold down **Code** while pressing and releasing **O (UseFm) + 2**. A stop code will be automatically inserted.
  - During playback, the stop code will remind you to change formats at this point. Type the following paragraph.

For example, a reference may be typed in a format similar to this one.

5. Hold down **Code** while pressing and releasing **O (UseFm) + 1**. Type this final paragraph.

When you finish the reference, you can switch to the original format. Format switching saves you the time and effort of resetting margins and tabs.

6. Press **Store** to close storage.
7. Play back the job, recalling format area 2 and then format area 1 when the typewriter stops at the stop codes.

## Advanced Revision

It is important to have a copy of the job for reference when you are revising in storage. *Do not* use a justified copy of your job.

If you have changed margins or pitch, be sure you play back your job while storage is open before revising.

You can revise a stored job by using the **Play**, **Advance**, and **Delete** keys. You can **Play**, **Del.** and **Advance**:

- one character at a time
- one word at a time
- one line at a time
- to a specific word
- to the end of a job.

The **Play** function allows you to play to the parts of the job that need revising.

The **Delete** function allows you to delete parts of the job quickly.

The **Advance** function allows you to move directly to the parts of the job that need revising *without printing the text*.

**Note:** If the **Store** light is blinking quickly, the typewriter is searching memory. You should *not* perform any typewriter function until the light stops blinking.

## Playing a Character, Word, or Line

1. Press **Store** + the number where you stored the job.
  - You are now at the beginning of the job.
2. Press **Play** + one of the following:
  - **Spacebar** to play a *character*.
  - **W (Word)** to play a *word* and the space after it.
  - **E (Line)** to play a *line*, including the carrier return at the end of the line.
3. The typewriter plays what you request.
  - If you play past the point you want to revise, press **Store** and return to step 1.
4. Press **Store** to close storage when you have finished.

## Practice

Practice playing by character, word, and line using the following exercise.

1. Insert paper; set margins and single line spacing.

	12 and PS Pitch	or	10 Pitch
LMar	12		10
RMarg	69		66

2. Press **Store** + the number where you want to store the job.
3. Type the paragraph printed below with **ARtn** on.
4. Press **Store**.

The world's first duel with typewriters was fought in Cincinnati, Ohio, in 1888. A Cincinnati, Louis Taub, challenged Frank McGurkin, a Salt Lake City court typist to a contest consisting of 45 minutes of direct dictation and 45 minutes of copying from a script.

**Note:** You will use this practice exercise throughout the remainder of this chapter.

## Playing To a Word or Words

Use **Play + To** when you want to play up to any word in the job.

1. Press **Store + the number** where you stored the job.
  - You are now at the beginning of the job.
2. Hold down **Play + Z (To)**.
  - The carrier moves to zero.
3. Type the word or words you want to play to.
  - These words may not exceed 28 characters.
  - The carrier moves with each character you type.
4. Press **Play** after you type the word or words you want to play to.
  - The typewriter plays the stored job *up to* the word or words you typed.
  - If you are either at the end of a job or the typewriter cannot find the word or words, the typewriter beeps. Make sure you have typed the word or words exactly as they appear in the job.
5. Press **Store** to close storage when you have finished.

## Practice

1. Hold down **Store** while you press the number where you stored the job.
  - You are now at the beginning of the job.
2. Hold down **Play** while you press **Z (To)** and type "Lake" with a capital L.
3. Press **Play**.
  - The paragraph will play to the L.

The world's first duel with typewriters was fought in Cincinnati, Ohio, in 1888. A Cincinnati, Louis Taub, challenged Frank McGurkin, a Salt Lake City court typist to a contest consisting of 45 minutes of direct dictation and 45 minutes of copying from a script.

## Playing All

After you have made all your revisions and are still in the storage area, you may want to play the rest of the job.

1. Hold down **Play + A (All)**.
  - The rest of the job is printed.
2. Press **Play** to stop playback at any point in the job.

**Note:** If there is nothing more to play, the typewriter beeps.

## Deleting a Character, Word, or Line

1. Press **Store + the number** where you stored the job.
  - You are now at the beginning of the job.
2. Press **Play** to play the portion of the job you want to save.
3. Press **Play** to stop *in front of* the character, word, or line you want deleted.
  - If you play past the point where you need to delete, press **Store** and return to step 1.
4. Hold down **Del + one of the following**:
  - **Spacebar** to delete a *character*.
  - **W (Word)** to delete a *word* and the space after it.
  - **E (Line)** to delete a *line* including the carrier return at the end of the line.
5. The printwheel spins and the character, word, or line is deleted from the storage area.

**Note:** To cancel the **Del** function, *do not* release the **Del** Key and then type a number larger than 100.

## Practice

The world's first duel with typewriters was fought in Cincinnati, Ohio, in 1888. A Cincinnati, Louis Taub, challenged Frank McGurkin, a Salt Lake City court typist to a contest consisting of 45 minutes of direct dictation and 45 minutes of copying from a script.

1. Press **Store** + the number to return to the beginning of the job.
2. Press **Play** + **W** (Word) to play "The" and the space after it.
3. Press **Del** + **W** (Word) to delete "world's" and the space after it.
4. Press **Play** + **Z** (To) and type "1888."
5. Press **Play**.
  - The paragraph plays up to the 1.
6. Type "September" and a comma and a space.
7. Press **Play** + **Z** (To) and type "a Salt."
8. Press **Play**.
  - Playback continues up to the "a."
9. Press **Del** + **E** (Line) to delete the rest of the line ("a Salt Lake City court typist" and the carrier return).
10. Press **Play** or **Play** + **A** (All) to play the rest of the job.

The job should now look like this.

The first duel with typewriters was fought in Cincinnati, Ohio, in September, 1888. A Cincinnati, Louis Taub, challenged Frank McGurkin, to a contest consisting of 45 minutes of direct dictation and 45 minutes of copying from a script.

## Deleting To a Word or Words

By using **Delete To**, you can delete from any point in the job to any word in the job.

1. Press **Store** + the number where you stored the job.
  - You are now at the beginning of the job.
2. Press **Play** to play the portion of the job you want to save.
3. Press **Play** to stop in front of the first word or words of the text you want to delete.
  - If you play past the portion of the job you want to save, press **Store** and return to step 1.
4. Hold down **Del** + **Z** (To).
  - The carrier moves to zero.
5. Type the word or words you want to delete to.
  - These words may not exceed 28 characters.
  - The carrier moves on each character typed.
6. Press **Del** after you type the word or words you want to delete to.
  - The text is deleted up to the word or words you typed.
  - The printwheel spins.
  - If the word or words cannot be found or if you are at the end of a job, the typewriter beeps. Make sure you have typed the word or words exactly as they appear in the job.
7. Press **Store** to close storage when you have finished.

## Practice

Use this practice to revise this job.

The first duel with typewriters was fought in Cincinnati, Ohio, in September, 1888. A Cincinnati, Louis Taub, challenged Frank McGurkin, to a contest consisting of 45 minutes of direct dictation and 45 minutes of copying from a script.

1. Press **Store** + the number.
  - You are now at the beginning of the job.
2. Press **Play** + **Z (To)** and type "A Cincinnati."
3. Press **Play**.
  - The typewriter plays up to the word "A."
4. Press **Delete** + **Z (To)** and type "of 45 minutes."
5. Press **Del**.
  - The words "A Cincinnati, Louis Taub, challenged Frank McGurkin, to a contest consisting" have been deleted. The space after "consisting" was also deleted.
6. Type "This contest consisted," plus a space.
7. Press **Play** + **A (All)**.
  - The rest of the job plays out.

The job should now look like this.

The first duel with typewriters was fought in Cincinnati, Ohio, in September, 1888. This contest consisted of 45 minutes of direct dictation and 45 minutes of copying from a script.

## Deleting All

1. Press **Store** + the number where you stored the job.
  - You are now at the beginning of the job.
2. Press **Play** to play the portion of the job you want to save.
  - If you play past the portion of the job you want to save, press **Store** and return to step 1.
3. Hold down **Del** + **A (All)**.
  - The printwheel spins.
  - The remainder of the job is deleted.
4. Begin typing or press **Store** to close storage.

**Note:** If there is nothing to delete, the typewriter beeps.

## Using Advance to Move Forward Through Storage

You have been using **Play** to play back the document as you moved through storage. For example, to move to line five, you had to play to line five.

Line 1 \_\_\_\_\_ In the late nineteenth century,  
Line 2 \_\_\_\_\_ typing speed contests drew  
Line 3 \_\_\_\_\_ enthusiastic spectators and  
Line 4 \_\_\_\_\_ provided free advertising for  
Line 5 \_\_\_\_\_ a struggling typewriter industry.

You can also move quickly through storage without playing back the document similar to turning quickly through the pages of a book without reading.

Use **Advnc** to move forward through storage without playing it back.

When you press **Advnc**, nothing erases from memory. You simply move forward through memory.



Advnc, like Play, moves you forward in memory, or down the page:

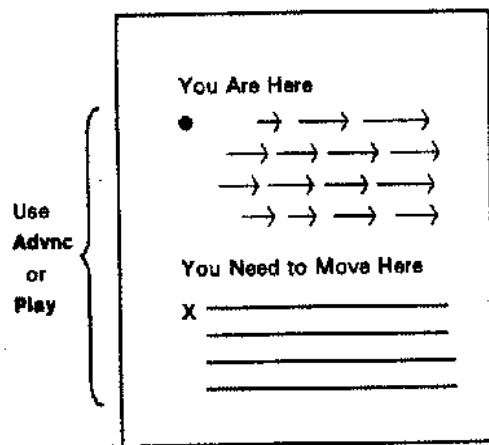

You can use Advnc just as you used Play: with Word, Line, Character, To, or All.

## Advancing a Character, Word, or Line

1. Press Store + the number where you stored the job.
  - You are now at the beginning of the job.
2. Hold down Advnc + one of the following:
  - Spacebar to advance a *character*.
  - W (Word) to advance a *word* and the space after it.
  - E (Line) to advance a *line*, including the carrier return.
3. The carrier moves to the next character, word, or line, the printwheel spins, and *no* text is printed.
  - If you advance past the point you need to revise, press Store and return to step 1.

## Practice

The first duel with typewriters was fought in Cincinnati, Ohio, in September, 1888. This contest consisted of 45 minutes of direct dictation and 45 minutes of copying from script.

1. Press Store + the number where you stored the job.
  - You are now at the beginning of the job.
2. Press Advnc + W (Word) twice to advance past "The first."
3. Press Play + W (Word) to play the word "duel."
4. Press Advnc + E (Line) to move to the beginning of the second line.
5. Press Play + E (Line) to play the line.
6. Practice using Advnc several times.

## Advancing to a Word or Words

1. Press **Store** + the number where you stored the job.
  - You are now at the beginning of the job.
2. Hold down **Advnc** + **Z (To)**.
  - The carrier moves to zero.
3. Type the word or words you want to advance to.
  - These words may not exceed 28 characters.
  - The carrier moves on each character you type.
4. Press **Advnc** after you type the word or words you want to advance to.
  - The carrier moves to the word or words you typed.
  - The printwheel spins and no text is printed.
  - If the word or words cannot be found, the typewriter beeps. Make sure you have typed the word or words exactly as they appear in the job.

## Practice

1. Press **Store** + the number.
  - You are now at the beginning of the job.
2. Press **Advnc** + **Z (To)** and type "This contest."
3. Press **Advnc**.
  - The typewriter moves to the T in "This."
  - Nothing is printed.
4. Press **Play** + **A (All)**.
  - The rest of the job plays out.

The first duel with typewriters was fought in Cincinnati, Ohio, in September, 1888. This contest consisted of 45 minutes of direct dictation and 45 minutes of copying from a script.

## Repeat Advance

The **Repeat Advance** function allows you to quickly move to a particular word in a stored job. There may be times when you want to move to *all occurrences* of a word so you can change it everywhere it appears. The **Repeat Advance** function lets you do this without retyping the word each time.

1. Press **Store** + the number where you stored the job.
  - You are now at the beginning of the job.
2. Hold down **Advnc** + **Z (To)**.
  - The carrier moves to zero.
3. Type the word or words you want to advance to.
  - These words may not exceed 28 characters.
  - The carrier moves on each character.
4. Press **Advnc**.
  - The carrier moves to the first occurrence of the word or words.
5. Hold down **Code** while you press **Advnc**.
  - The carrier moves to the next occurrence of the word or words.
6. Continue using **Code** + **Advnc** to move to each of the other occurrences of the word or words.
7. Press **Store** to close storage when you have finished.

## Advancing All

1. Press **Store** + the number where you stored the job.
  - You are now at the beginning of the job.
2. Hold down **Advnc** + **A (All)**.
  - The printwheel spins and no text is printed.
  - The typewriter is at the end of the job.
3. Begin typing.

**Note:** If there is nothing to advance to, the typewriter beeps.

## Copying a Job Into Another Storage Area

You may want to copy an entire or part of a job into another storage area. To copy part of a job, you must first copy the entire job and then delete the parts you do not want.

This is best explained by an example. The following steps will copy storage area 1 into storage area 2.

1. Type some text in storage area 1.
2. Press **Store** + 2.
3. Press **Play** + 1 plus the **Spacebar**.
  - This plays the first character, space, tab, and so on of the job.
4. Press **Advnc** + **A** (**All**).
  - You have now copied storage area 1 into storage area 2.
  - You have not changed anything in storage area 1.
5. Press **Store**.

## Helpful Hints

If the typewriter does not have enough memory for the entire job to be copied, the typewriter will beep, the **Store** light will blink, and only part of the job will be copied.

- When using **Play**, **Del**, and **Advnc** To:
  - Make sure you type the word or words *exactly* as they appear in the stored job.
  - Type no more than 28 characters for the word or words. The typewriter beeps and ignores each additional character you type.
- You can **Del** and **Advnc** through stop codes set for a multipage job.
- If you add text to a multipage job, the stop code set before revision will no longer indicate the end of your text on that page.
- If you turn off your typewriter while storage is open, you must reopen storage and play back or use **Advnc** + **All** to move to the end of the job.
- If the word you want to advance, delete, or play to is a short or common word, type several words up to 28 characters to define the destination more clearly. For example, if you want to advance to the word "is," it will advance to the first word containing the letters "is." This could be "his," "this," "island," and so on.
- If the word you want to advance, delete or play to contains a dead key, *do not* type the dead key (accent marks).
- If the word you want to advance, delete, or play to contains an overstrike, key *only one* of the overstrike characters. For example, if you have 0 0 0, key only "000" or "///."
- If you are playing text from one storage area to another, the **Play**, **Del**, and **Advnc** keys work with the storage area where the text is being played from until the end of the storage area is reached.

## Helpful Hints (continued)

- If the words you want to **Del**, **Advnc**, or **Play To** are separated by several spaces, a tab, or a carrier return, type only one space between the words. You do *not* need to type the exact number of spaces between words.
- If you use one of the revision functions and the typewriter beeps:
  - Be sure the **Store** light is on.
  - Press **relocate (Reloc)**.
  - Be sure you are not in centering or **DecT** mode.
  - Be sure you are not at the end of a job.
- While revising a document, it is possible to change line endings (for example, deleting or erasing a **CRtn**). This can cause the advance function to move the carrier past the right margin or to the extreme right.
- If the word(s) you are trying to correct is at or beyond the extreme right margin, press **Advnc + Line** and continue revising. Next, play the job with storage open and **ARtn** on to adjust your line endings. Now you can correct the error.
- If searching for the numbers "1" or "0" (on the number row), do not use the letters "l" or "o."
- To cancel any revision function, do *not* release the revision keys and then type a number larger than 100.

## Advanced Revision Terms and Definitions

Terms	Definitions
Character	<p>A <i>character</i> is:</p> <ul style="list-style-type: none"> <li>● a letter, number, or symbol;</li> <li>● a hyphen;</li> <li>● a mark of punctuation;</li> <li>● a space or required space;</li> <li>● a tab or indent instruction (<b>Code + Tab</b>);</li> <li>● a carrier return, automatic carrier return, or indent clear instruction (<b>Code + CRtn</b>);</li> <li>● a stop code (<b>Code + 9</b>);</li> <li>● a <b>Paper Up</b> or <b>Paper Down</b> movement;</li> <li>● a mark (<b>Shift + Code + M</b>).</li> </ul>
Word	<p>A <i>word</i> is:</p> <ul style="list-style-type: none"> <li>● a word or group of characters and the space or spaces following them;</li> <li>● a tab or indent instruction (<b>Code + Tab</b>);</li> <li>● a space or several spaces;</li> <li>● a stop code (<b>Code + 9</b>);</li> <li>● a <b>Paper Up</b> or <b>Paper Down</b> movement;</li> <li>● a carrier return, automatic carrier return, or indent clear instruction (<b>Code + CRtn</b>);</li> <li>● a mark (<b>Shift + Code + M</b>).</li> </ul>
Line	<p>A <i>line</i> is:</p> <ul style="list-style-type: none"> <li>● a line of words, including the carrier return or automatic carrier return;</li> <li>● a carrier return or automatic carrier return by itself;</li> <li>● the remainder of the line, including the carrier return, if you are not at the beginning of the line.</li> <li>● a <b>Paper Up</b> or <b>Paper Down</b> movement.</li> </ul>
All	<b>All</b> takes you from where you are in a stored job to the end of the stored job.
To	<b>To</b> takes you from where you are in a stored job to the beginning of the word or words you select.

**Note:** It is important to have a copy of the job for reference when you are revising in storage. Do not use the justified copy of your job.

## Alternate Keyboards

Complete this section *only* if you have a printwheel for other languages or special applications (Library or Trilingual).

Your typewriter has primary and alternate keyboards. You have already been using your primary keyboard.

- The primary keyboard lets you type in your home language. Your typewriter automatically sets your primary keyboard to match the keybuttons on your typewriter.
- Alternate keyboards let you type in other languages such as French, Spanish or special applications such as Library or Trilingual when used with the appropriate printwheel.

### Keyboard/Printwheel Identification Numbers

Each printwheel for alternate keyboards contains characters other than those printed on your typewriter keybuttons. You can access characters of an alternate keyboard by typing a keyboard change called a keyboard identification (ID) number.

The keyboard ID is printed on all printwheels. When more than one set of numbers is printed, the first number is the keyboard ID, for example, 001-008. The keyboard ID for the United States keyboard is 001 or 1. These keyboard ID numbers are listed on pages 5-6 and 5-7. Look at the example below.

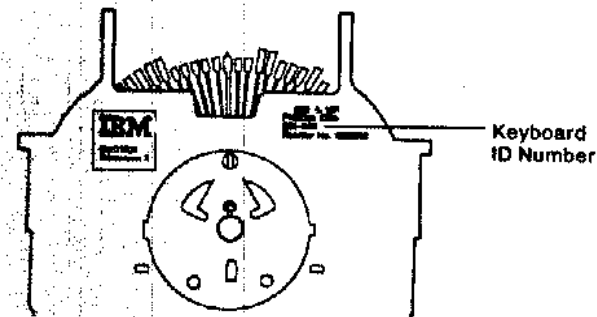

See the list on page 5-6 and 5-7 for alternate keyboard ID numbers.



## Helpful Hints

- If you are using the primary keyboard, your typewriter automatically sets the keyboard to match the keybuttons on your typewriter keyboard.
  - You do not have to type the keyboard ID 001. However, be sure you have a printwheel ID 001 in your typewriter.
- To type in alternate keyboards for accent marks, universal symbols, or Latin and Greek characters only, use the Latin Supplemental keyboard and printwheel 099.
  1. Select keyboard ID 099 (Latin Supplemental).
  2. Select the matching printwheel (ID 099).
  3. Hold down **Code** while you press **X**.
    - You do not have to type the keyboard ID 099. However, be sure you have a printwheel ID 099 in your typewriter.
  4. When you finish typing, hold down **Code** while you press **X** to turn the **Language** light off.
- To type in alternate keyboards for other languages or special applications:
  1. Select the keyboard and ID number.
  2. Select the matching printwheel (same number as keyboard ID).
  3. Press **Code** + **X** + ID number.
  4. When you finish typing, hold down **Code** while you press **X** to turn the **Language** light off.
- When typing an alternate keyboard ID, use the numeric keys to type the one (1) and the zero (0).
- Always make sure the **Language** light is off when you are not typing in alternate keyboards.
- If you are storing jobs using alternate keyboards, type a stop code at the point where you want to change the printwheel to type in another language.
  - When you play back the job, playback will stop at the point where you want to change the printwheel and the keyboard ID number.

**Note:** You will learn how to store and play back jobs in the next section.

## Helpful Hints (continued)

- Many alternate keyboards contain accent marks which are dead keys. Dead keys print without advancing the carrier to the next space. To type accent marks over alphabetic characters:
  1. Type the accent mark first.
    - If the accent mark is a dead key, the carrier will not advance to the next space.
  2. Type the alphabetic character.
- The alternate keyboard charts show some keybuttons with three characters. To access the third (bottom) character, see page 2-11.

The keyboard for each country and special application has an identification number. The list on page 5-6 and 5-7 shows the name of the country and special application printwheels and their keyboard identification (ID) numbers. See pages 7-1 through 7-3 for a list of printwheel types and pitches available for use with your primary keyboard.

**Note:** Alternate keyboards have some keybuttons with three characters. To access the third (bottom) character, see page 2-11. Use the keyboard charts on pages 5-8 through 5-17 to type symbols, accent marks, and characters in another language.

## Keyboard Alphabetic Cross-Reference

Keyboard Name	ID Number	Page
Argentina	35	5-9
Australia	1	5-8
Austria	29	5-8
Belgium	251	5-18
Bulgaria	227	5-15
Canada (Bilingual)	39	5-9
Canada (English)	1	5-8
Czechoslovakia (Czech)	83	5-13
Czechoslovakia (Slovak)	85	5-13
Denmark	58	5-11
Finland	53	5-10
France	251	5-18
Germany (East)	34	5-9
Germany (West)	29	5-8
Greece (Greek)	219	5-14
Greece (Latin)	207	5-14
Hong Kong	119	5-13
Hungary	109	5-13
Italy	41	5-9
Japan (English)	69	5-12
Japan (Katakana)	221	5-15
Latin America	25	5-8
Netherlands	43	5-10
New Zealand	1	5-8
Norway	55	5-11
Poland	213	5-14
Portugal	63	5-11
Rumania	217	5-14

Keyboard Name	ID Number	Page
South Africa	81	5-12
Spain	70	5-12
Sweden	53	5-10
Switzerland (French)	49	5-10
Switzerland (German)	51	5-10
Turkey	79	5-12
United Kingdom	67	5-11
United States	1	5-8
USSR	231	5-15
Yugoslavia (Cyrillic)	225	5-15
Yugoslavia (Latin)	233	5-18

## Keyboards for Special Applications

Keyboard Name	ID Number	Page
Latin Supplemental	99	5-17
Library	111	5-17
Trilingual	113	5-17



## Alternate Keyboard Charts

The following keyboard charts show the keyboard ID numbers and the character locations. The charts are arranged numerically. These keyboards are available for your typewriter.

### Keyboard ID 1 — Australia, Canada (English), New Zealand, US

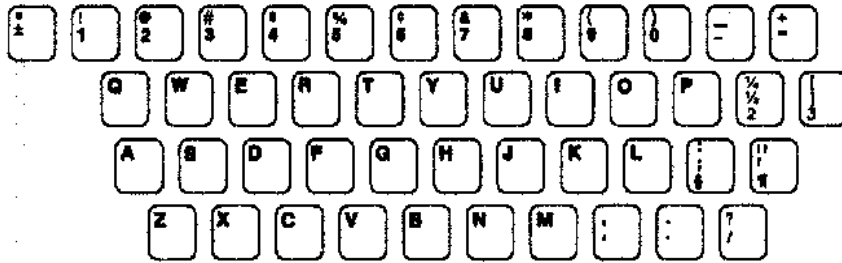

### Keyboard ID 25 — Latin America

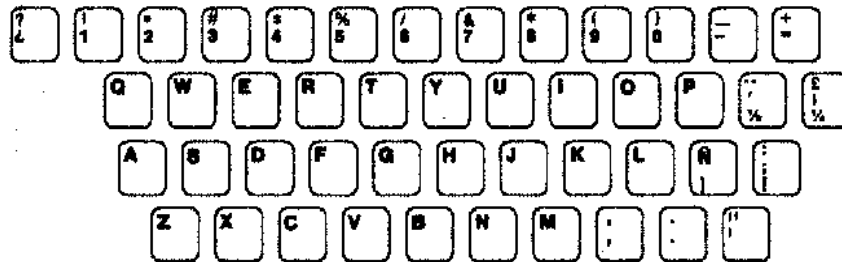

### Keyboard ID 29 — Austria, Germany (West)

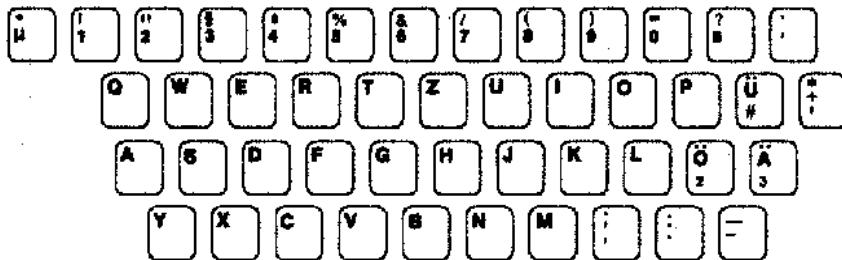

### Keyboard ID 34 — Germany (East)

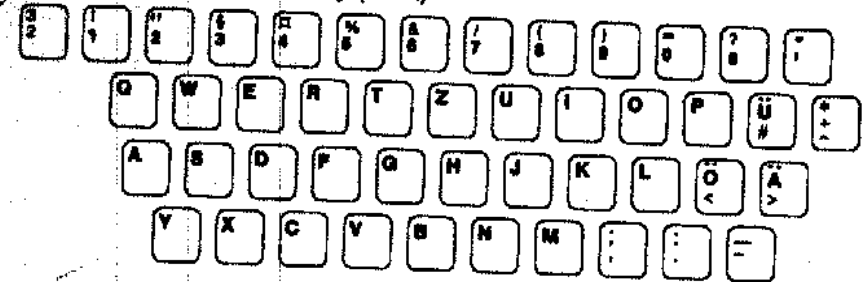

### Keyboard ID 35 — Argentina

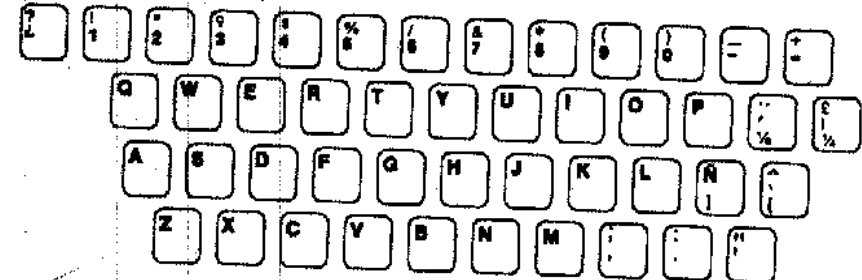

### Keyboard ID 39 — Canada (Bilingual)

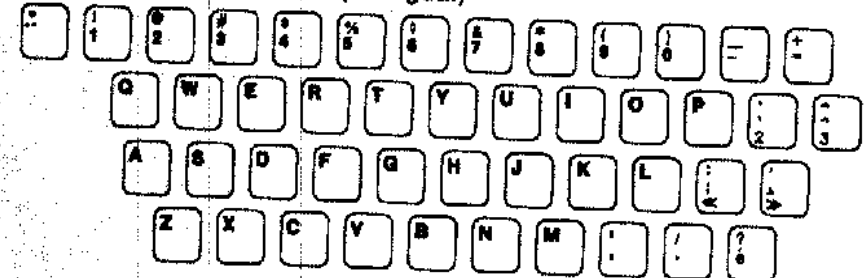

### Keyboard ID 41 — Italy

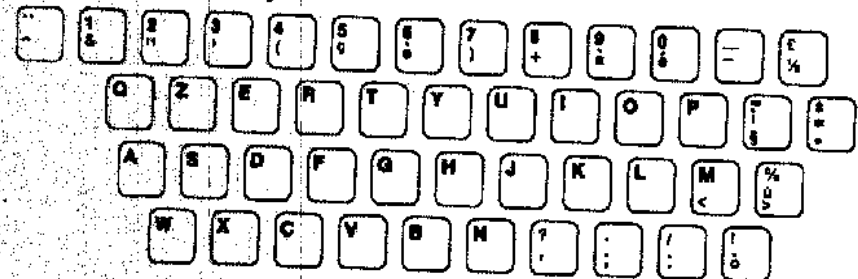

Keyboard ID 43 — Netherlands

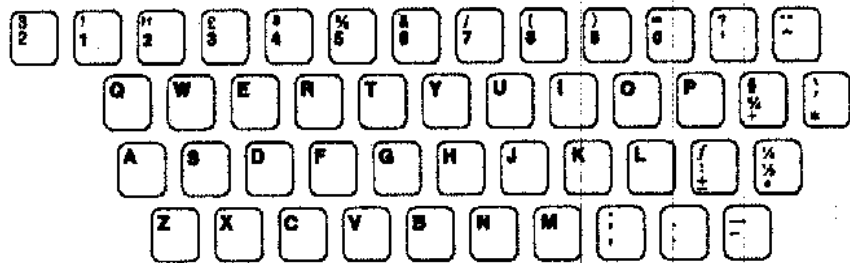

Keyboard ID 49 — Switzerland (French)

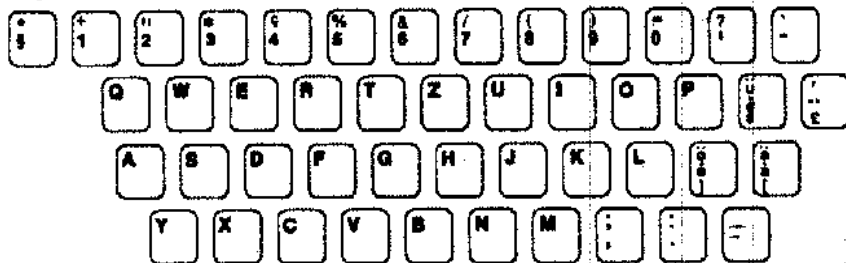

Keyboard ID 51 — Switzerland (German)

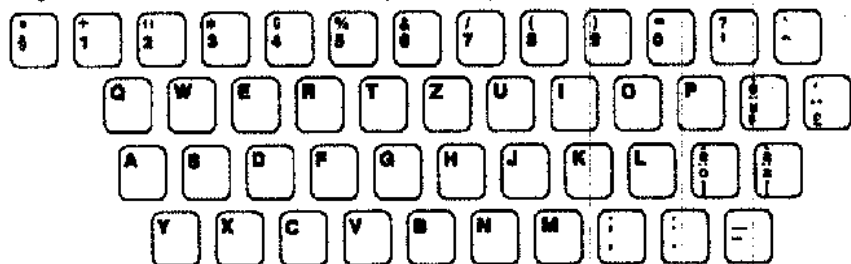

Keyboard ID 53 — Finland, Sweden

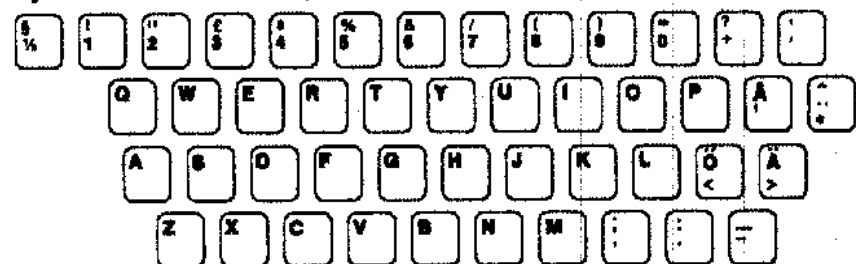

Keyboard ID 55 — Norway

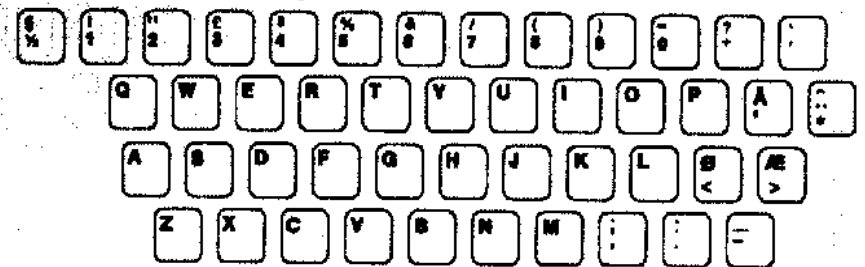

Keyboard ID 59 — Denmark

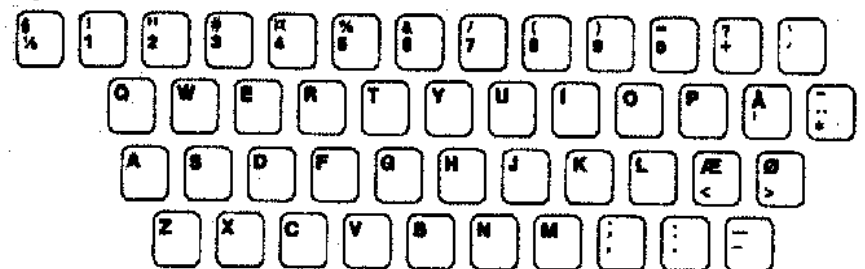

Keyboard ID 63 — Portugal

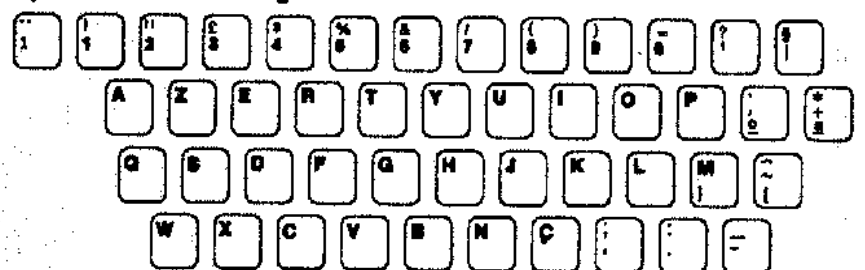

Keyboard ID 67 — United Kingdom

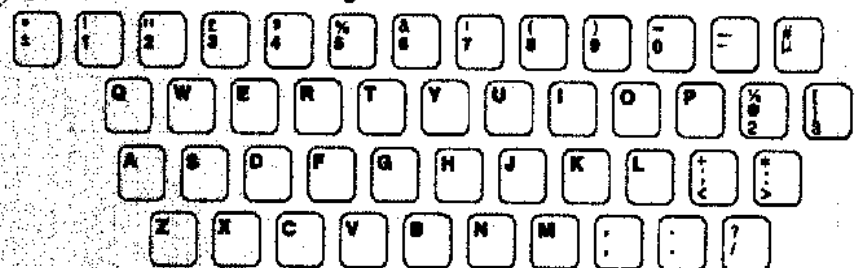

Keyboard ID 69 — Japan (English)

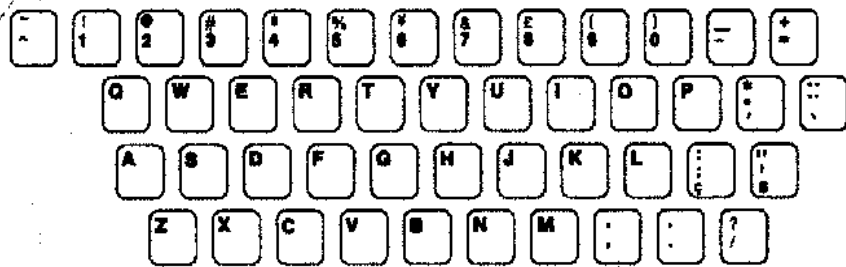

Keyboard ID 70 — Spain

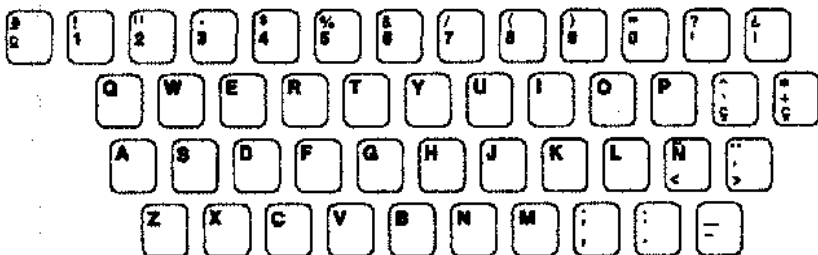

Keyboard ID 79 — Turkey

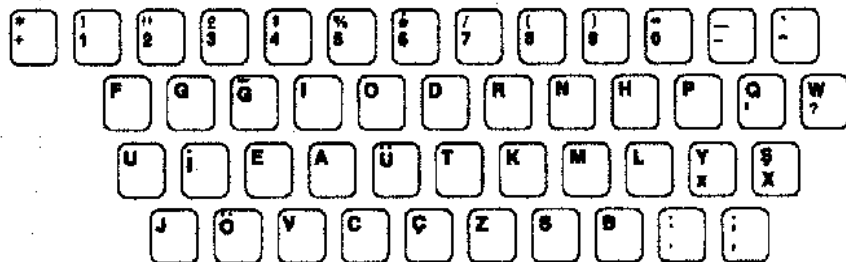

Keyboard ID 81 — South Africa

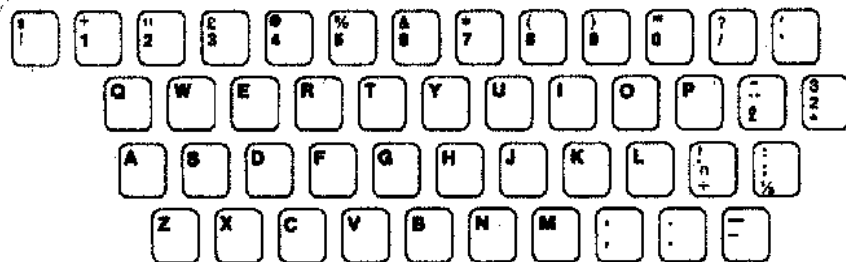

Keyboard ID 83 — Czechoslovakia (Czech)

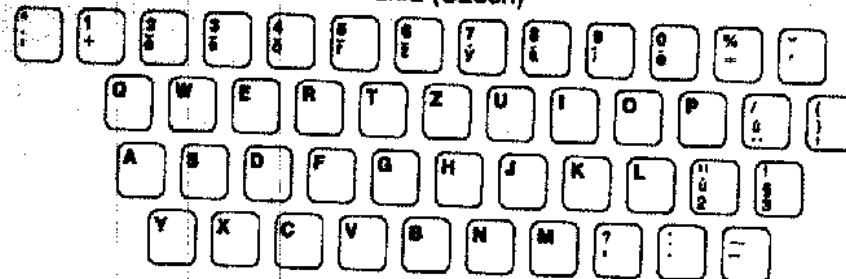

Keyboard ID 85 — Czechoslovakia (Slovak)

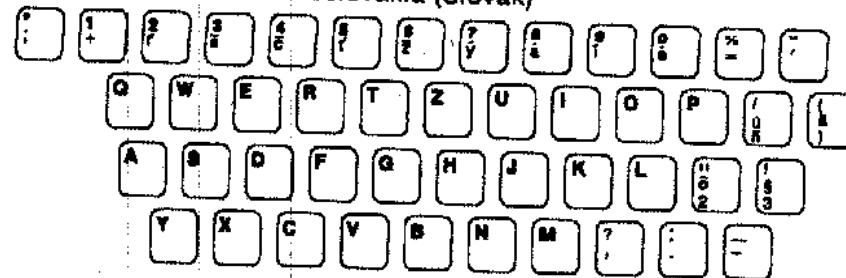

Keyboard ID 109 — Hungary

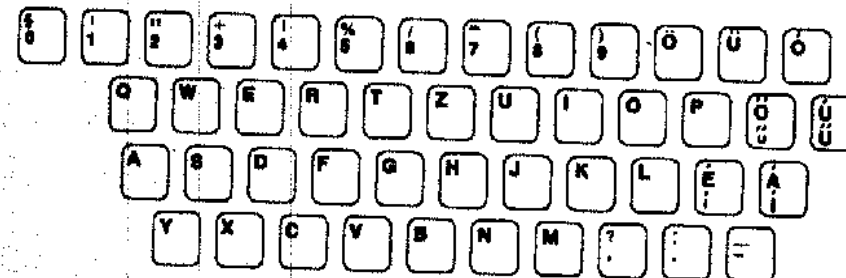

Keyboard ID 119 — Hong Kong

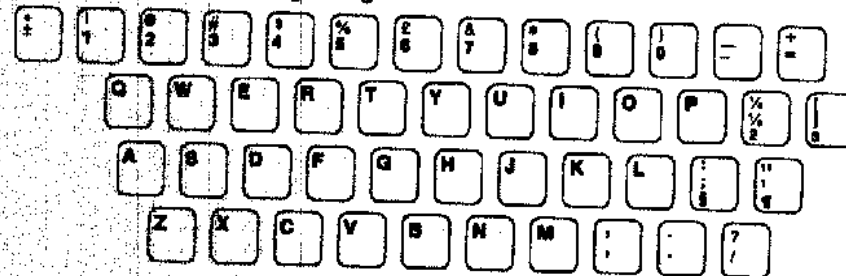

Keyboard ID 207 — Greece (Latin)

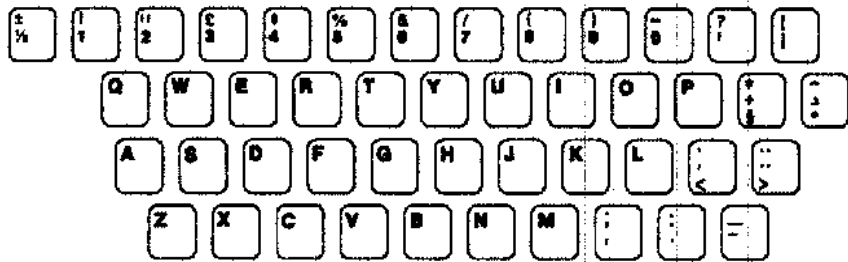

Keyboard ID 213 — Poland

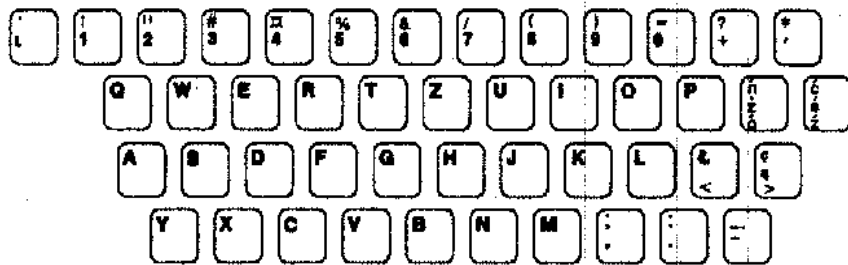

Keyboard ID 217 — Rumania

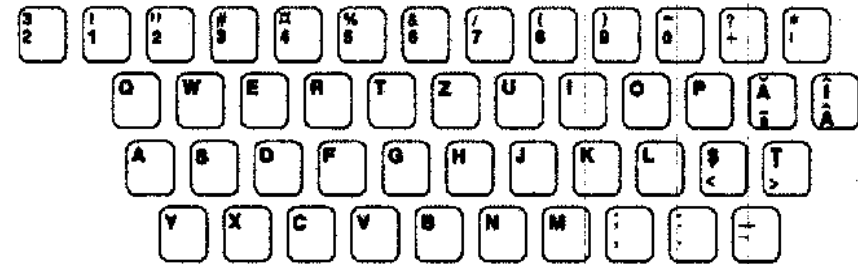

Keyboard ID 219 — Greece (Greek)

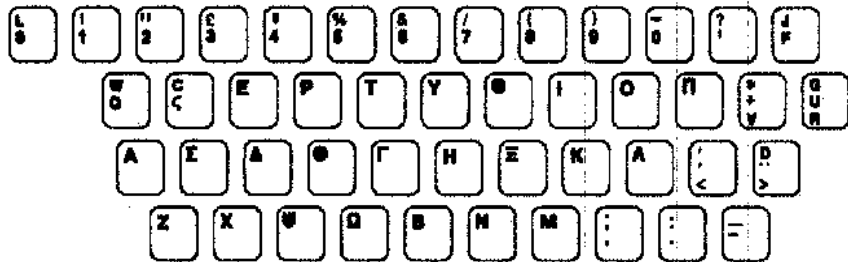

Keyboard ID 221 — Japan (Katakana)

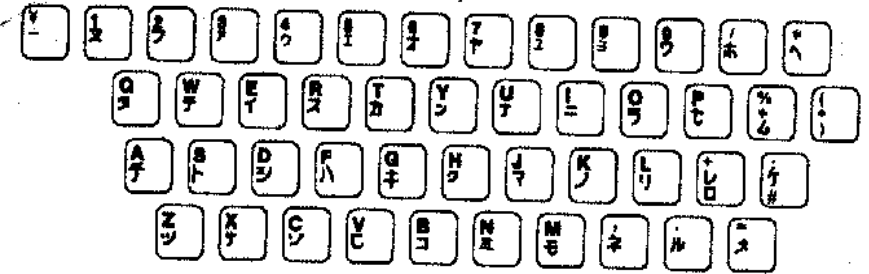

Keyboard ID 225 — Yugoslavia (Cyrillic)

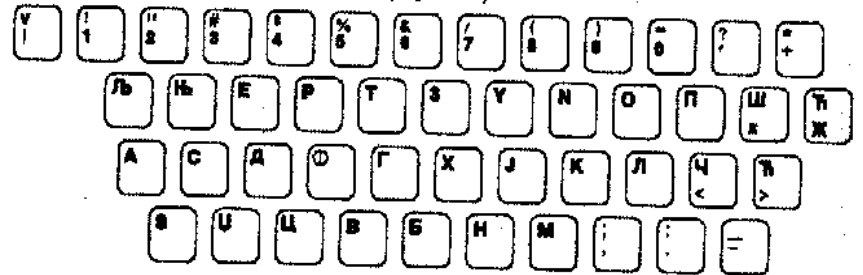

Keyboard 227 — Bulgaria

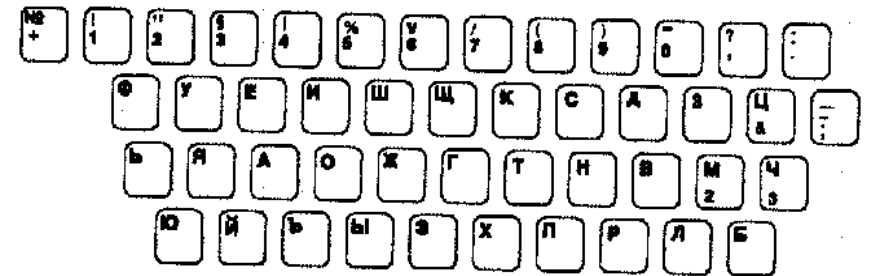

Keyboard ID 231 — USSR

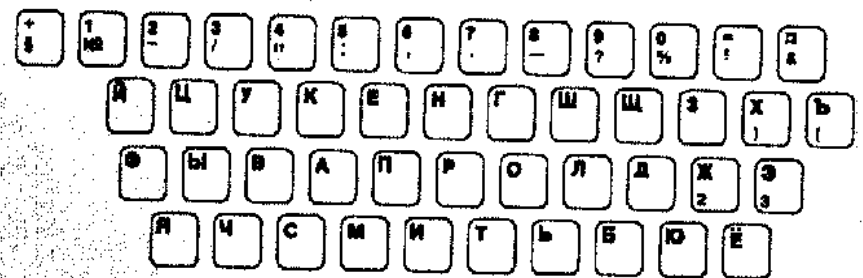



## **Problem Determination**

### **How to Use This Section**

If you have a problem while using your typewriter, use this section to help you solve the problem.

You may be able to correct the problem without help from a service representative and avoid unnecessary downtime and service costs.

Before you call for service:

1. Find your problem in the index on the next page.
2. Turn to the page referenced.
3. Complete as many steps as needed to correct the problem.
  - Try using the typewriter after completing each step.
4. If you cannot correct the problem or need help completing the steps, call your IBM Authorized Dealer.

## Problem Determination Index

Beeper and Light Signals	6-3
Beeper Signals Three Times	6-3
Beeper Signals Three Times and Line Space Lights Blink	
Continuously	6-3
Beeper Signals Three Times and the Store Light Blinks	6-3
Beeper Signals Each Time You Press a Key and the Store	
Light Blinks	6-4
Beeper Signals Six Times and One or More Lights Blink	6-4
All Lights Stay On	6-4
No Lights Come On	6-4
Erasing Problems	6-5
Correction Does Not Erase All of the Character or Character	
Leaves Shadows	6-5
Typewriter Problems	6-6
Typewriter Dead (No Lights Come On)	6-6
Typewriter Operates Hot	6-6
Typewriter Too Noisy	6-6
Print Quality Problems	6-7
Characters Do Not Print	6-7
Characters Print Too Lightly	6-7
Typing Problems	6-8
Line Spacing Aligns Incorrectly	6-8
Paper Feeds Incorrectly	6-8
Wrong Characters Print or Characters Space Incorrectly	6-8
Wrong Character Spacing or Breaks in Underline	6-8

## Beeper and Light Signals

### Beeper Signals Three Times

Wait until the typewriter stops printing, then continue typing. You were typing faster than the typewriter could accept your typing.

### Beeper Signals Three Times and Line Space Lights Blink Continuously

If the beeper signals three times and the **Line Space** lights blink continuously when you turn the typewriter on:

- The batteries are installed incorrectly, *or*
- No batteries are installed, *or*
- The batteries are weak, *or*
- The batteries are dead.

Check the following while the typewriter is on:

1. Make sure the battery holder wire plug is connected. (See page 7-12 in the Reference section.)
2. Look at the batteries for correct installation.
  - If the batteries are installed correctly, the batteries may be weak or dead.
3. Replace all three weak or dead batteries.
  - Do not turn the typewriter off while replacing the old batteries. If you turn the typewriter off without batteries installed, margins, tabs, and storage will be lost. Refer to "Batteries" on page 7-12 in the Reference section for correct installation, type and size of batteries.

### Beeper Signals Three Times and the Store Light Blinks

Do not continue to type. You must create more space if you want to store the remainder of the job. See "Storage Full Warning" on page 3-27. However, if you do not want to continue to store, press **Store**.

## **Beeper Signals Each Time You Press a Key and the Store Light Blinks**

Storage is full. Delete one or more storage areas or press **Store** to close storage. If you press **Store**, reposition the carrier to the last typing position and continue typing. See "Storage Full Warning" on page 3-27 for more information.

## **Beeper Signals Six Times and One or More Lights Blink**

1. Make sure the printwheel is installed correctly.
2. Make sure the ribbon and correction tape cassettes are installed correctly.
3. Turn the typewriter off, wait 30 seconds, then turn the typewriter on again. If the same thing happens, install another printwheel.
4. Turn the typewriter off, wait 30 seconds, then turn the typewriter on again. If the same thing happens, call for service.
  - Tell your service person which lights are blinking when you place the call.

## **All Lights Stay On**

Turn the typewriter off, wait 30 seconds, then turn the typewriter on again. If all the lights still stay on, call for service.

## **No Lights Come On**

1. Make sure the typewriter cord is plugged into the back of the typewriter.
2. Turn the typewriter off, wait 30 seconds, then turn the typewriter on again.
3. Make sure the typewriter is plugged into a wall outlet.
4. Make sure the extension cord, if you are using one, is plugged into the typewriter cord.
5. Look to see if any other equipment plugged into the same wall outlet operates.
6. Make sure the wall outlet does not turn off with the room lights.

## **Erasing Problems**

### **Correction Does Not Erase All of the Character or Character Leaves Shadows**

1. Make sure the ribbon and correction tape cassettes are fastened together correctly.
  - Make sure the center latch is latched securely. (See page 7-9 in the Reference section.)
  - Make sure the gray tabs are pressed in. (See pages 7-9 in the Reference section.)
2. Make sure the ribbon and correction tape cassettes are installed in the typewriter correctly. (See page 7-9 in the Reference section.)
3. Try plain bond paper.
4. Try a new correction tape.
5. Look for folds in the paper.
6. Make sure the typewriter is on a level surface.



## Typewriter Problems

### Typewriter Dead (No Lights Come On)

1. Make sure the typewriter cord is plugged into the back of the typewriter.
2. Turn the typewriter off, wait 30 seconds, then turn the typewriter on again.
3. Make sure the typewriter is plugged into a wall outlet.
4. Make sure the extension cord, if you are using one, is plugged into the typewriter cord.
5. Look to see if any other equipment plugged into the same wall outlet operates.
6. Make sure the wall outlet does not turn off with the room lights.

### Typewriter Operates Hot

1. Make sure nothing is blocking the top, rear, or bottom typewriter vents.
2. Make sure the typewriter is at least 75 mm (3 in) from the wall on all sides.
3. Make sure the typewriter is not near a heater.

### Typewriter Too Noisy

1. Make sure the cover and soundhood, if you have a soundhood, are closed tightly.
2. Move any objects touching the typewriter cover.
3. Look for objects in the typewriter.
4. Remove any material placed under the typewriter.
5. Check the typing table or desk. (Metal tables can make the typewriter sound noisy.)

## Print Quality Problems

### Characters Do Not Print

1. Turn the typewriter off, wait 30 seconds, then turn the typewriter on again.
  - Try typing again.
2. Make sure the ribbon is installed correctly.
3. Make sure the printwheel is installed correctly.
  - Look at the printwheel for broken parts.
4. Make sure the platen is latched down at both ends.
  - Pull the paper release lever all the way toward you.
  - Push down firmly on each end of the platen. Then push the paper release lever all the way back.

### Characters Print Too Lightly

1. Make sure the ribbon is installed correctly.
2. Look for folds in the ribbon.
3. Change the impression control. (Press Code + Q.)
4. Look for folds in the paper.
5. Try a new ribbon.
6. Try plain bond paper.
7. Try a new printwheel.

---

## Typing Problems

### Line Spacing Aligns Incorrectly

1. Look for objects inside the typewriter.
2. Look at the number of carbon copies being used (five maximum).
3. Make sure the paper release lever is pushed all the way back.

### Paper Feeds Incorrectly

1. Check the number of carbon copies being used (five maximum).
2. When inserting loose carbon copies, pull the paper release lever forward. Insert the copies, then push the lever all the way back.
3. Look for labels or paper caught under the platen.
4. Make sure the paper release lever is pushed all the way back.
5. Make sure the platen is latched down at both ends.
  - Pull the paper release lever all the way toward you.
  - Push down firmly on each end of the platen. Then push the paper release lever all the way back.

### Wrong Characters Print or Characters Space Incorrectly.

1. Turn the typewriter off, wait 30 seconds, then turn the typewriter on again.
2. Try typing again.
3. Make sure the Language light is off.
4. Try a new printwheel.
5. Look for objects in the path of the carrier.

### Wrong Character Spacing or Breaks in Underline

If you are playing back from storage, make sure you use the same pitch printwheel you used when you stored the job.

---

## Reference

Use this chapter to learn how to:

- Order IBM supplies for the typewriter.
- Remove and install the ribbon and printwheel in the typewriter.
- Change batteries.
- Take care of your typewriter.

This chapter also contains recommendations for ribbons and printwheels for various applications.

---

## Ordering Procedures for IBM Supplies

To order IBM supplies, contact an IBM Authorized Dealer or call IBM Direct at 1-800-IBM-2468. In Canada, call IBM Direct at 1-800-465-1234.

---

## Typestyle Samples

The IBM Cartridge Printwheel II is designed for use with IBM Wheelwriter® Typewriters and IBM Wheelprinters. The protective cartridge makes installation easy and protects the printwheel from damage. The wide variety of typestyles and sizes allows you to select one for readability, emphasis, or space requirements to make your work look the way you want.

The order number listed is for the American Standard Character Set. Personal computer, foreign language, and symbol character sets are also available.

- ▲ = 10 pitch
- △ = 12 pitch
- = 15 pitch
- = proportional spacing

**Note:** Because of the differences between printed and typewritten impressions, the typestyle samples on the following pages should be used only as a guide.

## Typestyle Samples and Pitches

### 10 Pitch

▲ Advocate 1353845	IBM's variety of attractive type
▲ Artisan 10 1353520	IBM's variety of attractive type
▲ Bookface Academic 1353844	IBM's variety of attractive type
▲ Courier 10 1353511	IBM's variety of attractive type
▲ Delegate 1353843	IBM's variety of attractive type
▲ Manifold 1353846	IBM'S VARIETY OF ATTRACTIVE TYPE
▲ OCR-A 1353248	IBM's variety of attractive type
▲ OCR-B 1353247	IBM's variety of attractive type
▲ Pica 1353829	IBM's variety of attractive type
▲ Presentor 1353015	IBM's variety of attractive type
▲ Prestige Pica 1353503	IBM's variety of attractive type
▲ P&P #3 OCR 1353054	IBM's variety of attractive type
▲ Rhetoric 1353736	IBM'S VARIETY OF ATTRACTIVE TYPE
▲ 1403 OCR 1353075	IBM'S VARIETY OF ATTRACTIVE TYPE

### 12 Pitch

△ Adjutant 1353047	IBM's variety of attractive typestyles suit
△ Artisan 12 1353050	IBM's variety of attractive typestyles suit
△ Auto Elite 1353080	IBM's variety of attractive typestyles suit
△ Courier 12 1353523	IBM's variety of attractive typestyles suit
△ Courier 12 Italic 1353880	IBM's variety of attractive typestyles suit
△ Dual Gothic 1353055	IBM's variety of attractive typestyles suit

### 12 Pitch (continued)

△ Elite 1353881	IBM's variety of attractive typestyles suit
△ Large Elite 1353017	IBM's variety of attractive typestyles suit
△ Letter Gothic 1353514	IBM's variety of attractive typestyles suit
△ Light Italic 1353784	IBM's variety of attractive typestyles suit
△ Olde World 1353875	IBM's variety of attractive typestyles suit
△ Prestige Elite 1353502	IBM's variety of attractive typestyles suit
△ Scribe 1353882	IBM's variety of attractive typestyles suit
△ Script 1353778	IBM's variety of attractive typestyles suit

### 15 Pitch

■ Courier 15 1353786	IBM's variety of attractive typestyles suit many
■ Gothic 15 1353719	IBM's variety of attractive typestyles suit many
■ Prestige 15 1353655	IBM's variety of attractive typestyles suit many

### Proportional Spacing

● Boldface * 1353504	IBM's variety of attractive typestyles suit
● Boldface Italic * 1353059	IBM's variety of attractive typestyles suit
● Essay * 1353528	IBM's variety of attractive typestyles suit
● Essay Italic * 1353130	IBM's variety of attractive typestyles suit
● Modern * 1353517	IBM's variety of attractive typestyles suit
● Thesis * 1353953	IBM's variety of attractive typestyles suit
● Title * 1353952	IBM's variety of attractive typestyles suit

\* For use on typewriters and printers with proportional spacing.

## Printwheel Application Recommendations

Typestyle	1-3 Carbon Copies	3-5 Carbon Copies	Stencils	Bold Print
<b>10 Pitch:</b>				
Advocate	A	A	A	C
Artisan 10	A	A	A	A
Bookface Academic	B	C	B	A
Courier 10	A	A	B	A
Delegate	A	A	B	B
Manifold	A	A	B	A
Pica	A	A	A	C
Prestige Pica	A	B	B	A
Rhetoric	B	C	B	A
Rhetoric Presentor	B	C	B	A
Symbol 10	B	C	C	B
<b>12 Pitch:</b>				
Adjutant	A	A	B	B
Artisan 12	A	A	B	A
Auto Elite	A	A	A	A
Courier 12	A	A	B	A
Courier 12 Italic	A	A	B	A
Dual Gothic	A	B	B	C
Elite	A	A	A	C
Large Elite	A	A	A	C
Letter Gothic	A	A	B	A
Light Italic	A	A	A	B
Olde World	A	C	NR	A
Prestige Elite	A	B	A	A
Scribe	A	A	A	B
Script	B	C	C	A
Symbol 12	C	C	C	B

Ratings:  
 A - Good; B - Fair; C - Marginal; NR - Not Recommended  
 (Based on proper selection of ribbon, carbon paper, and stencils)

Typestyle	1-3 Carbon Copies	3-5 Carbon Copies	Stencils	Bold Print
<b>15 Pitch:</b>				
Courier 15	A	B	B	A
Gothic 15	B	C	B	A
Prestige 15	A	B	A	C
Symbol 15	C	C	C	B
<b>PS Pitch:</b>				
Boldface	B	C	B	A
Boldface Italic	B	C	B	A
Essay	A	B	B	A
Essay Italic	A	B	B	A
Modern	A	B	B	A
Thesis	A	B	B	A
Title	A	B	B	A

Ratings:  
 A - Good; B - Fair; C - Marginal  
 (Based on proper selection of ribbon, carbon paper, and stencils)

**Note:** There are three symbol printwheels: Symbol 10, Symbol 12, and Symbol 15. For best results, use a symbol printwheel that matches the pitch of your regular printwheel. For example, use Symbol 15 with 15-pitch typestyles.

## Removing the Printwheel

### CAUTION

To prevent unwanted carrier motion, make sure the paper ball is against the platen.

1. Pull the print hammer all the way toward you and hold it.
2. While you are holding the print hammer, grasp the printwheel tab.
3. Lift the printwheel straight up and out of the slot. Be careful not to scratch the ribbon.
4. Release the print hammer.

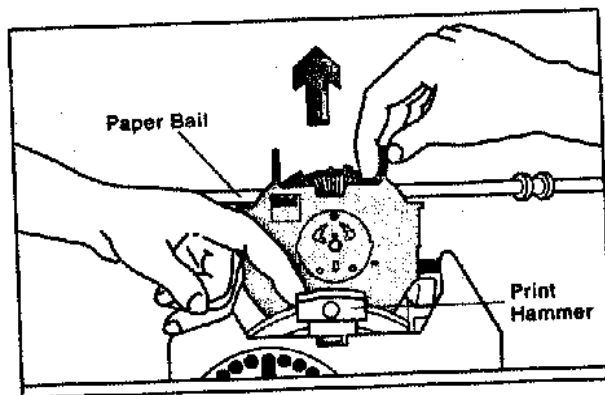
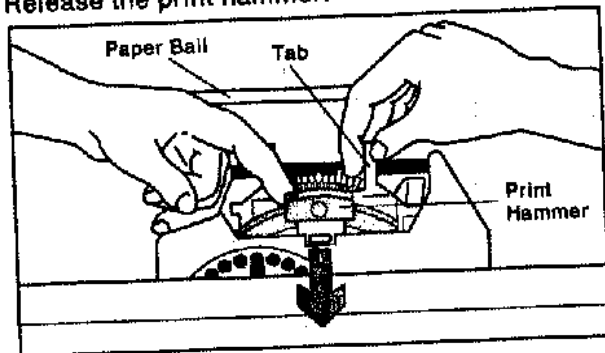

## Installing the Printwheel

**Important:** Remove the yellow shipping seal from the center of a new printwheel before you install it.

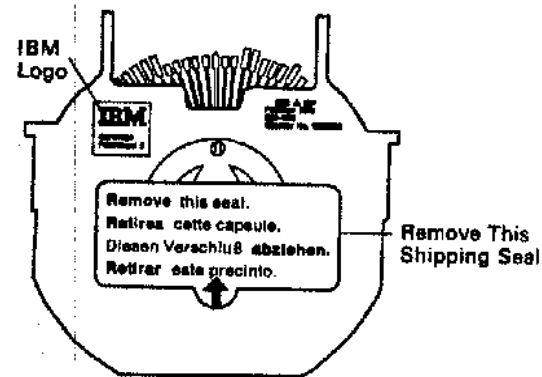

### CAUTION

To prevent unwanted carrier motion, make sure the paper ball is against the platen.

1. Hold the printwheel so the letters IBM are in the upper left corner.
2. Pull the print hammer all the way toward you and hold it.
3. While you are holding the print hammer, lower the printwheel into the slot. Be careful not to scratch the ribbon.
4. After the printwheel touches the bottom of the slot, release the print hammer.
5. Press the **Code** key:
  - The printwheel spins.

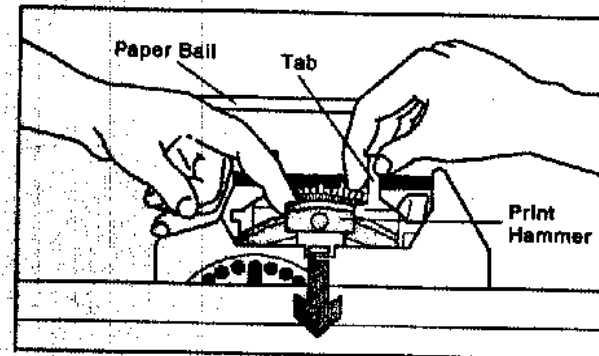

## Ribbon Cassette System

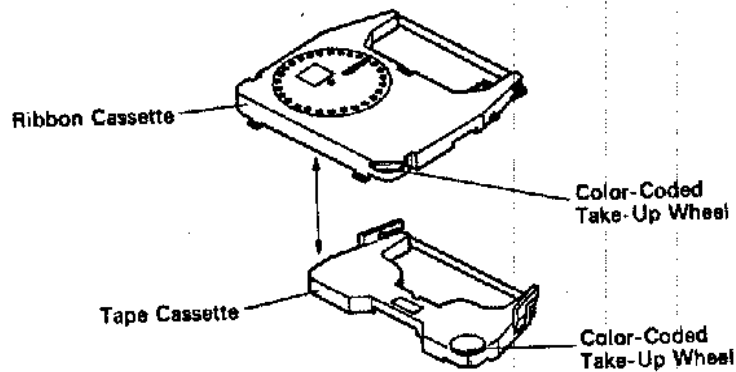

The ribbon and tape cassettes fasten together. Each type of ribbon and tape cassette has a color-coded take-up wheel. In most cases the wheel color helps you match the ribbon to the correction tape. (See "Ribbon Cassette Reorder Numbers" on page 7-11.) The color also tells you which type of ribbon you are using.

## Removing the Cassettes

1. Space or tab to the center of your typewriter.
2. Raise the typewriter cover.
3. Make sure the paper ball is against the platen.
4. Push the release lever until the cassettes release.
5. Lift the cassettes up and out of the typewriter.

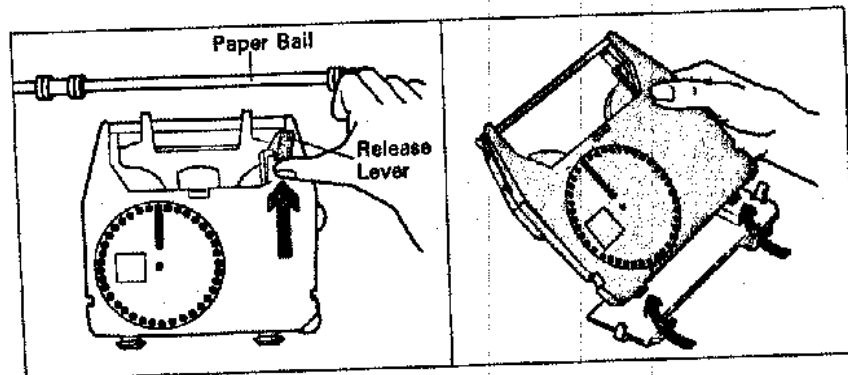

## Installing the Cassettes

1. After you remove the cassettes from your typewriter, press on the top of the center latch, slide the cassettes apart and throw away the used cassette.
2. Slide the ribbon cassette onto the tape cassette.
  - Be sure the center latch latches onto the correction tape.
3. Press the gray tabs (on both ends of the correction tape) to be sure the tape and ribbon cassettes are latched together.
4. Before installing the ribbon in the typewriter, tighten any slack in the ribbon by turning the take-up wheels to move the color-coded leaders past the center.
5. Install the cassettes in your typewriter.
6. Push down on the upper right corner of the ribbon cassette to snap it into place.

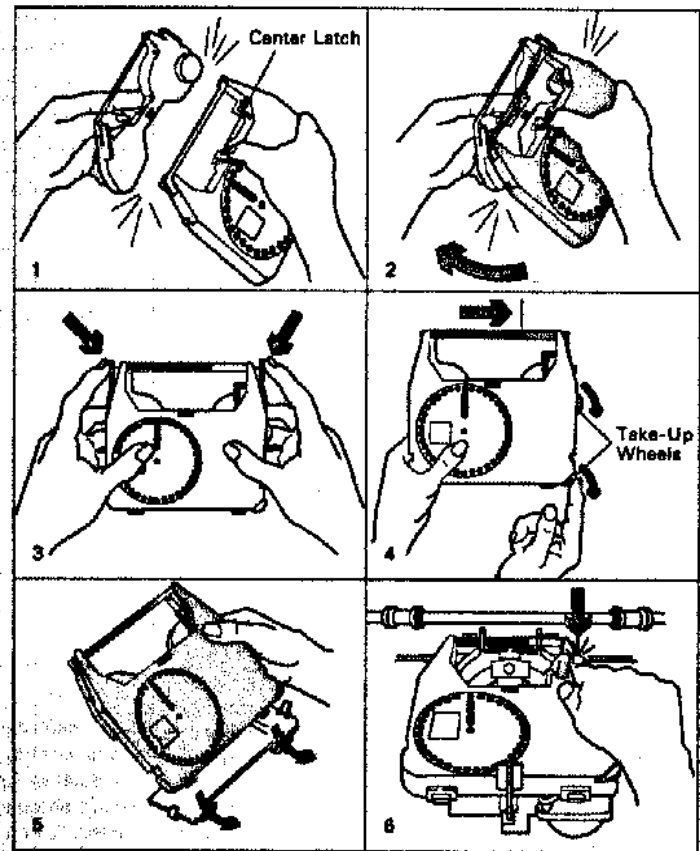

## Ribbon Application Recommendations

Typing Applications	Multi-purpose Ribbon Cassette	High Yield Correctable Ribbon Cassette	Fabric Ribbon Cassette	Superior Write Correctable Ribbon Cassette
Legal Correspondence	●	●	NR	●
Executive Correspondence	●	●	NR	●
General Correspondence	●	●	●	●
Hard-to-Image Originals <sup>1</sup>	●	NR	●	●
OCR	●	NR	NR	NR
Speech Writing <sup>2</sup>	●	NR	●	●
Negotiable Instruments — (checks, stocks, and so on)	●	NR	●	NR
Erasable Bond <sup>1</sup>	●	NR	NR	●
Quality of Original				
1 - 3 Carbons	Good	Good	Good	Good
3 - 5 Carbons	Fair	Marginal	Fair	Fair

● = Recommended

NR = Not Recommended

## Ribbon Cassette Reorder Numbers

Use the table below to find the reorder number for the matching cassettes you need.

Ribbon	Wheel Color	Correction Tape	Wheel Color
IBM Easystrike® High Yield Correctable Ribbon Cassette <sup>3</sup> Reorder Number: 1299845 (black only)	Orange	IBM Easystrike® Lift-Off Tape Cassette Reorder Number: 1337765	Orange
IBM Easystrike® Correctable Ribbon Cassette Reorder Numbers: 1337761 (black) 1337762 (brown) 1337763 (blue)	Orange	IBM Easystrike® Lift-Off Tape Cassette Reorder Number: 1337765	Orange
IBM Easystrike® Superior Write Correctable Ribbon Cassette <sup>4</sup> Reorder Number: 1380999 (black only)	Purple	IBM Easystrike® Lift-Off Tape Cassette Reorder Number: 1337765	Orange
IBM Easystrike® Multi-purpose Ribbon Cassette Reorder Number: 1337764 (black only)	Blue	IBM Easystrike® Cover-Up Tape Cassette Reorder Number: 1337766	Blue
IBM Easystrike® Fabric Ribbon Cassette Reorder Number: 1356000 (black only)	Red	None	None

<sup>1</sup> The receptivity of the surface of these materials varies widely and care must be used in the selection of a specific material to be typed on, typestyle, impression control and ribbon to produce the best result. The IBM Easystrike® Superior Write Correctable Ribbon is recommended for most hard-to-image applications. However, there are some special coated or treated surfaces where the multipurpose ribbon must be used. When in doubt, prepare samples first.

<sup>2</sup> Best results with Rhetoric and other large typestyle printwheels are obtained by using the IBM Easystrike® Multipurpose Ribbon.

<sup>3</sup> Long-life correctable film ribbon; recommended for general correspondence.

<sup>4</sup> Recommended for bold and dark print, especially on difficult-to-image papers.

## Batteries

Your typewriter uses three size AA alkaline batteries. These batteries are used to save margins, tabs and other settings when the typewriter is turned off. They must be installed correctly and changed at least once every year (before they run down).

When changing the batteries, use only size AA alkaline batteries (for example, Duracell<sup>®</sup> type MN 1500, Eveready<sup>®</sup> type E91, Ray-O-Vac<sup>®</sup> type 815, or equivalent). Do not use rechargeable batteries.

## Checking the Batteries

If the beeper signals three times and the **Line Space** lights blink continuously when you turn the typewriter on, check the following while the typewriter is on:

1. Look at the batteries for correct installation.
2. If the batteries are installed correctly, the batteries may be weak or dead.
3. Replace all three weak or dead batteries.
4. Do not turn the typewriter off while replacing the old batteries. If you turn the typewriter off without batteries installed, margins and other settings will be lost. (See page 7-14 for correct installation.)

### Notes:

1. The **Line Space** lights blink *alternately* indicating the battery is low, but you have not lost your settings.
2. The **Line Space** lights blink *continuously* indicating you have lost your settings.

<sup>5</sup> Trademark of Duracell, Inc.

<sup>6</sup> Trademark of the Union Carbide Corp.

<sup>7</sup> Trademark of the Ray-O-Vac Corp.

## Removing Old Batteries

**Warning:** Do not turn the typewriter off while replacing the old batteries. If you turn the typewriter off without batteries installed, margins and other settings will be lost.

1. Make sure the typewriter is turned on.
2. Raise the typewriter cover.
3. Locate the black plastic battery holder on the right front side of the typewriter.
4. Remove the holder by putting your finger under it and pushing up. Then carefully pull the holder out as far as it can go.
5. Push the batteries against the spring ends of the holder and pop them out.

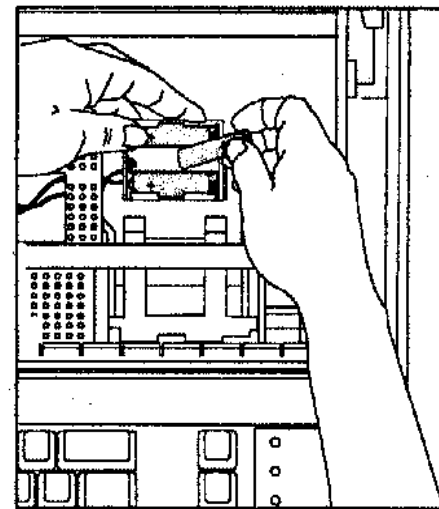
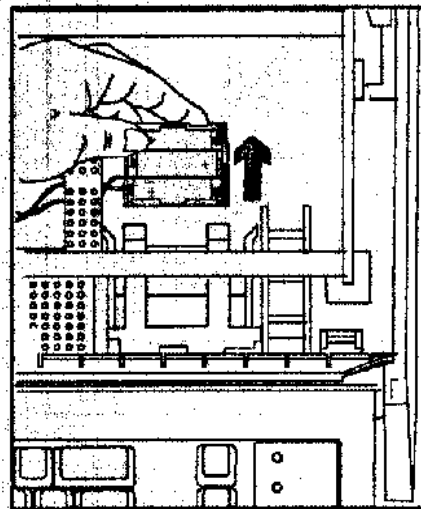



## Installing New Batteries

1. Install three (3) new batteries in the holder by placing the flat end of the batteries against the springs.
  - Make sure the plus (+) signs on the batteries match the plus signs inside the holder.
2. Place the battery holder back into the typewriter.

**Note:** The batteries will *not* save margins and other settings in the correction memory unless the plus sign on each battery matches the plus sign inside the holder.

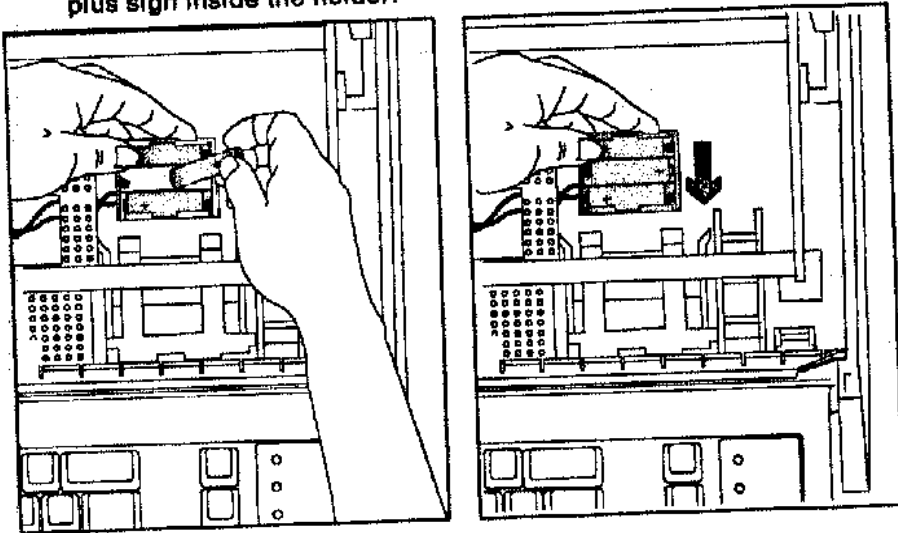

## Care and Maintenance

### Cleaning the Typewriter Cover

**Important:** Use only a damp cloth and mild detergent to clean the typewriter cover and keybuttons. Certain cleaning fluids may be harmful. *Do not use IBM cleaning fluid.*

### Serial Number

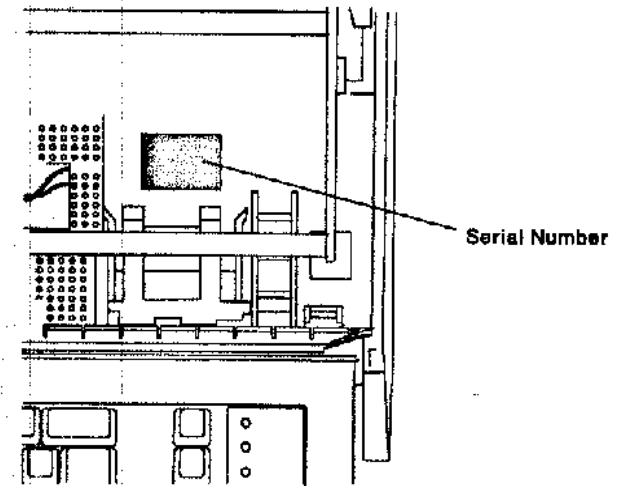

To locate the serial number on your typewriter, look on the right of the inside bottom cover. The serial number (S/N) is shown on the voltage label behind the batteries.

## Index

### A

- addressing envelopes 3-39
  - adjustments
    - keyboard 1-2
  - advanced revision
    - advancing all 4-31
    - advancing character 4-29
    - advancing line 4-29
    - advancing word 4-29
  - copying job into another storage area 4-32
  - definitions 4-35
  - deleting all 4-27
  - deleting to word(s) 4-25
  - playing all 4-23
  - playing character 4-21
  - playing line 4-21
  - playing to word(s) 4-22
  - playing word 4-21
  - repeat advance 4-31
  - terms 4-35
- advanced storage
- using 4-1
- Advno key 4-27
- aligning
- numbers in columns 2-19
  - paper 1-4
- alphabetic keyboard
- cross-reference 5-8
- alternate keyboards 5-8
- keyboard charts 5-8
  - special applications 5-7
  - using other alternate keyboards 5-3
- ARm
- during playback 3-5
  - while storing 3-2
- assistance 6-1
- automatic 2-1
- carrier return 2-1
  - centering 2-7
  - erase in proportional spacing 2-23
  - erase in 10, 12, or 15 pitch 1-18

automatic pitch selection 1-7

### B

- batteries
- checking 7-12
  - installing 7-14
  - removing 7-13
  - replacement recommendations 7-12
- beeper signals 6-3
- Bkap1 key 2-22
- to insert a character 2-22
- blinking light signals 6-3

### C

- Caps key 2-17
- cardholder 1-9
- care and maintenance 7-15
- carrier returns
- after a permanent hyphen 3-20
  - after a short line 2-2
  - after a syllable hyphen 3-20
  - erasing extra 1-24
- cassette, ribbon 7-8
- installing 7-9
  - ordering 7-11
  - removing 7-8
- centering 2-7
- at any point on the page 2-7
- centering marks 1-8
- changing
- batteries 7-13
  - printwheels 7-6
  - ribbon cassettes 7-8
- character storage capacity 3-1
- characters per horizontal inch 1-7
- checking the batteries 7-12
- cleaning the typewriter cover 7-15
- Code key 1-14
- combining stored jobs 3-35
- continuous underline 2-5

copying a job into another storage area 4-32  
correcting errors with storage open 3-22  
correction key 1-18  
correction memory 1-17  
Ctrl key 2-7

## D

decimal tabulation  
cancelling 2-20  
double underlining numbers in a column 2-20  
setting up and typing columns with decimals 2-18  
setting up and typing columns without decimals 2-19  
underlining numbers in a column 2-20  
Del key 3-26  
deleting 3-26  
all storage areas 3-26  
stop code 3-16  
to make space available 3-28  
to the end of storage 3-26  
Dir key 4-2  
double underline 2-20  
drawing vertical lines 1-9

## E

elite (12 pitch) 1-6  
erasing  
automatically in 10, 12, or 15 pitch 1-18  
center instruction 2-8  
character noticed immediately 1-18  
farther back on the same line 1-18  
in proportional spacing in 10, 12, or 15 pitch 2-23  
manually in proportional spacing 2-24

on previous lines 1-20  
problems 6-5  
stop code 3-18

## F

format storage 4-17  
saving 4-17  
using 4-17  
forms 4-4  
function keys 1-14

## H

hyphens 3-20

## I

Impression Control 2-12  
InCtrl key 2-14  
indent key 2-13  
indenting  
setting a temporary left margin 2-13  
inserting an extra character 2-22  
inserting paper 1-4  
installing  
new batteries 7-14  
printwheels 7-7  
ribbon cassettes 7-9

## J

job, definition of 3-2  
justification 4-11  
completing last line of each page 4-15  
Jatify key 4-11  
justifying parts of a job 4-12  
multipage jobs 4-13  
playback 4-11  
resuming playback 4-11  
stopping playback 4-11

## K

keyboard alphabetic cross-reference 5-6  
keyboard height adjust lever 1-2  
keyboard ID 5-1  
keyboards  
alternate 5-8  
charts 5-8  
keyboard height adjustment 1-2  
primary 5-1  
special applications 5-7

## L

language  
keyboard charts 5-8  
keyboard ID numbers 5-1  
language light 5-2  
latching the ribbon cassettes together 7-9  
left margin 1-10  
lever  
keyboard height adjust 1-2  
paper bail load 1-4  
paper release 1-4

## Lights

Lang 5-3  
Line Space 1-13  
Shift Lock 1-15  
Store 3-27  
line spacing  
lights 1-13  
line space key 1-13  
setting 1-13  
lines  
drawing vertical 1-9  
on cardholder 1-8  
per vertical inch 10, 12, 15, and PS pitch 1-7  
lines per vertical inch 1-7

LMar key 1-10  
Lock key 1-16  
log sheet 3-29

## M

maintenance and care 7-15  
making corrections in storage  
adding 3-7, 3-8  
removing 3-10, 3-12  
replacing 3-13, 3-15  
manual erase 2-24  
margin/pitch scale 1-8  
margins  
indenting the left 2-16  
releasing the left 1-10  
saving 1-11  
setting 1-10  
mark 4-4  
Mark key 4-4  
playing back form layout 4-8  
storing a form layout 4-6  
MarRel key 1-10  
Micro Down key 1-5  
micro elite (15 pitch) 1-6  
Micro Up key 1-5  
moving and removing paper 1-5  
moving forward through storage 4-27  
MRtn key 2-9  
multipage jobs 4-13  
justification 4-13  
playing back with stop codes 3-19  
storing 3-18  
multipage jobs, storing formats 4-13  
multiple word underline 2-5

## O

on/off switch 1-1  
one-unit backspace 2-22  
ordering procedures (supplies) 7-1

## P

- page end indicator 1-3
- page end scale 1-3
- paper
  - alignment 1-4
  - insertion 1-4
  - moving and removing 1-5
- paper bail load lever 1-4
- Paper Down** key 1-5
- paper edge indicator 1-4
- paper edge scale 1-4
- paper movement keys 1-5
- paper release lever 1-4
- Paper Up** key 1-5
- parts of the typewriter 1-1
- permanent hyphens 3-20
- pica (10 pitch) 1-6
- pitch
  - selection, automatic 1-7
  - sizes 1-6
- pitch symbols 1-8
- play 4-23
  - all 4-23
- Play** key 3-5
- playback 3-5
  - beginning 3-5
  - continuing 3-5
  - continuing after a stop code 3-16
  - one or more characters 3-5
  - revising during 3-7, 3-15
  - stopping 3-5
  - stored job 3-5
- playing back a multipage job with stop codes 3-19
- primary keyboard 5-1
- print hammer 7-6
- printwheel 7-6
  - applications 7-4
  - identification 1-6
  - installing 1-7, 7-7
  - pitch table 1-7
  - pointer 1-6, 1-9

- removing 7-6
- problem determination 6-1
  - assistance 6-1
  - erasing 6-5
  - how to use 6-1
  - index 6-2
  - print quality 6-7
  - typewriter 6-8
  - typing 6-8
- proportional spacing (PS), erasing in 2-23
  - automatically 2-23
  - manually 2-24
- proportional spacing defined 2-23

## R

- recommended batteries 7-12
- reference 7-1
- Reloc** key 1-18
- removing
  - batteries 7-13
  - printwheels 7-6
  - ribbon cassettes 7-8
- repeat (typematic) keys 1-16
- repeat advance 4-31
- repetitive letters 3-31
- required spaces 2-3
- revising a stored job 3-7, 3-15
  - adding a word 3-7
  - deleting to the end of storage 3-26
  - removing a word 3-10
  - replacing a word 3-13
- ribbon
  - cassette system 7-8
  - installing 7-9
  - latching cassettes together 7-9
  - removing 7-8
  - reorder numbers 7-11
  - take-up wheel color code 7-11
  - typing applications 7-10
- ribbon release lever 7-8
- RMAR** key 1-10

## S

- safety information iv
- samples, typestyles 7-1
- saving format settings 4-17
- saving margins 1-11
- saving tabs 1-12
- scale, margin/pitch 1-6
- serial number 7-15
- setting a temporary left margin 2-13
- Shift** and **Shift Lock** keys 1-15
- Shift** key 1-15
- single word underline 2-6
- spaces (required) 2-3
- special applications keyboards 5-7
- special characters 2-11
- stencils 7-4
- stop code 3-16
  - continuing after playback stops 3-16
  - erasing 3-16
  - letter 3-31
  - Stop** key 3-16
  - typing 3-16
- storage
  - advanced storage 4-1
  - closing 3-3
  - combining stored jobs 3-35, 3-38
  - deleting 3-26
  - finding jobs in 3-29
  - full 3-27
  - full warning 3-27
  - log 3-29
  - opening 3-2
  - playing back a stored job 3-5, 3-6
  - revising 3-7, 3-15
  - typing into 3-3
- storage capacity 3-1
- Store** key 3-2
- Store** light
  - blinking 3-27
  - on 3-2
- storing 3-1
  - deleting 3-26
  - indented jobs 3-24

- jobs 3-2
- paragraphs 3-37
  - using an alternate keyboard 3-17
  - with **ARtn** off 3-6
  - with **ARtn** on 3-6
  - with permanent hyphens 3-20
  - with syllable hyphens 3-20
  - with underlining 3-22
- storing formats
  - SavFm** key 4-17
  - UseFm** key 4-17
- storing formats, multipage jobs 4-13
- subscripts 2-10
- superscripts 2-10
- supplies, ordering procedures 7-1
- syllable hyphens 3-20

## T

- tabs
  - clearing all 1-12
  - saving 1-12
  - setting 1-12
- TClr** key 1-12
- temporary left margin
  - canceling 2-16
  - left of a temporary left margin 2-16
  - setting 2-14
- TSet** key 1-12
- type sizes (pitch) 1-6
- typematic (repeat) keys 1-16
- typestyle samples 7-1
- typewriter
  - care and maintenance 7-15
  - supplies 7-1

## U

- underlining
  - continuous 2-6
  - double underlining columns 2-20
  - multiple word 2-6
  - numbers in a column 2-20
  - using format settings 4-17

**V**

vertical lines, drawing 1-9

**W**warning, storage full 3-27  
Word key 4-21IBM Wheelwriter® 6 Series II Typewriter 6784  
Operator's Guide  
Order Number S544-4213-1**Reader's  
Comment  
Form**

You may use this form to communicate your comments about this publication, with the understanding that IBM may use or distribute whatever information you supply in any way it believes appropriate without incurring any obligation to you.

1. Did you find the book well organized?

Yes  No 

2. Was the content of the book accurate and complete?

Yes  No 

3. Was the book easy to use?

Yes  No 

4. What can we do to improve the book?

---

---

---

5. What is your job title?

---

Questions or comments about supplies, service, applications, and so on will slow response time considerably. Please refer those questions or comments to your IBM Authorized Dealer or IBM Direct.

*Note: Please direct all requests for copies of IBM publications to your IBM Authorized Dealer. Publications are not stocked at the location to which this form is addressed.*



NO POSTAGE  
NECESSARY  
IF MAILED  
IN THE  
UNITED STATES



# BUSINESS REPLY MAIL

FIRST CLASS PERMIT NO. 123 LEXINGTON, KY 40511

POSTAGE WILL BE PAID BY ADDRESSEE

International Business Machines Corporation  
Department F98, Building 962-3  
740 New Circle Road, N.W.  
Lexington, Kentucky 40511

Fold Here

Tape

Please Do Not Staple

Tape