



## 2600 Series User's Guide

**January 2009**

**[www.lexmark.com](http://www.lexmark.com)**

---

Machine type(s):

4433, 4445

Model(s):

Various, xxx, where "x" is any alphanumeric character

# Contents

<b>Safety information.....</b>	<b>5</b>
<b>Introduction.....</b>	<b>6</b>
Finding information about the printer.....	6
<b>Setting up the printer.....</b>	<b>9</b>
Bypassing security warnings during software installation.....	9
Setting up the printer as a copier only.....	9
Understanding the parts of the printer.....	14
Using the printer control panel.....	16
<b>Understanding the printer software.....</b>	<b>18</b>
Installing printer software.....	18
Installing the optional XPS driver (Windows Vista users only).....	18
Using the Windows printer software.....	19
Using the Macintosh printer software.....	20
<b>Loading paper and original documents.....</b>	<b>22</b>
Loading paper.....	22
Loading various paper types.....	22
Loading original documents on the scanner glass.....	25
<b>Printing.....</b>	<b>27</b>
Printing basic documents.....	27
Printing a document.....	27
Printing Web pages.....	27
Printing multiple copies of a document.....	28
Collating printed copies.....	28
Printing the last page first (reverse page order).....	29
Printing multiple pages on one sheet (N-Up).....	29
Pausing print jobs.....	30
Canceling print jobs.....	31
Printing specialty documents.....	32
Choosing compatible specialty paper types.....	32
Printing photos using printer software.....	32
Printing envelopes.....	33
Printing labels.....	34

Printing on custom-size paper.....	35
Printing other specialty documents .....	36
Saving and deleting print settings.....	36
<b>Copying.....</b>	<b>38</b>
Making a copy.....	38
Copying 4 x 6 photos.....	38
<b>Scanning.....</b>	<b>39</b>
Scanning original documents.....	39
Canceling scan jobs.....	39
<b>Faxing.....</b>	<b>41</b>
Sending a fax.....	41
Receiving a fax automatically.....	41
<b>Maintaining the printer.....</b>	<b>43</b>
Maintaining print cartridges.....	43
Installing print cartridges.....	43
Removing a used print cartridge .....	44
Refilling print cartridges.....	45
Using genuine Lexmark print cartridges.....	45
Cleaning the print cartridge nozzles.....	46
Wiping the print cartridge nozzles and contacts.....	46
Preserving the print cartridges .....	47
Cleaning the scanner glass.....	47
Cleaning the exterior of the printer.....	47
Ordering supplies.....	48
Ordering print cartridges .....	48
Ordering paper and other supplies.....	48
Recycling Lexmark products.....	49
<b>Troubleshooting.....</b>	<b>50</b>
Using the printer troubleshooting software (Windows only).....	50
Setup troubleshooting.....	50
Power button is not lit .....	50
Software did not install.....	51
Page does not print.....	52
Removing and reinstalling the software .....	54
Enabling the USB port in Windows .....	55
Solving printer power problems .....	56

**Notices.....57**  
Product information.....57  
Edition notice.....57  
Power consumption.....60

**Index.....73**

# Safety information

Use only the power supply and power supply cord provided with this product or the manufacturer's authorized replacement power supply and power supply cord.

Connect the power supply cord to an electrical outlet that is near the product and easily accessible.

 **CAUTION—POTENTIAL INJURY:** Do not twist, bind, crush, or place heavy objects on the power cord. Do not subject the power cord to abrasion or stress. Do not pinch the power cord between objects such as furniture and walls. If the power cord is misused, a risk of fire or electrical shock results. Inspect the power cord regularly for signs of misuse. Remove the power cord from the electrical outlet before inspecting it.

Refer service or repairs, other than those described in the user documentation, to a professional service person.

This product is designed, tested, and approved to meet strict global safety standards with the use of specific Lexmark components. The safety features of some parts may not always be obvious. Lexmark is not responsible for the use of other replacement parts.

 **CAUTION—SHOCK HAZARD:** Do not set up this product or make any electrical or cabling connections, such as the power supply cord or telephone, during a lightning storm.



 **CAUTION—SHOCK HAZARD:** To avoid the risk of electric shock when cleaning the exterior of the printer, unplug the power cord from the wall outlet and disconnect all cables from the printer before proceeding.

**SAVE THESE INSTRUCTIONS.**

# Introduction

## Finding information about the printer

### Publications

See the	For
<i>Quick Setup</i> sheet	Initial setup instructions.
Printed <i>Networking Guide / Fax Guide</i>	Additional setup instructions. <b>Note:</b> Your printer may not come with these publications.
Electronic <i>User's Guide</i>	Complete instructions for using the printer. The electronic version installs automatically with the printer software.
Windows Help	Additional instructions for using the printer software on a Windows operating system. The Help installs automatically with the programs. <ol style="list-style-type: none"><li>1 Do one of the following:<ul style="list-style-type: none"><li>• In Windows Vista, click .</li><li>• In Windows XP and earlier, click <b>Start</b>.</li></ul></li><li>2 Click <b>All Programs</b> or <b>Programs</b>, and then select the printer program folder from the list.</li><li>3 From the program, click <b>Help</b> to view the main page of the Help. Click  to view context-sensitive information.</li></ol>
Mac Help <b>Note:</b> Your printer may not have support for Macintosh and may not have this Help.	Additional instructions for using the printer software on a Macintosh operating system. The Help installs automatically with the applications. <ol style="list-style-type: none"><li>1 From the Finder desktop, double-click the printer folder.</li><li>2 Double-click the application.</li><li>3 From the application, click <b>Help</b> on the menu bar to view the main page of the Help. <b>Note:</b> If you have several applications open, then make sure that the application that you want to use is the active application. The correct menu bar does not appear if the application is not active. Click the main screen to make it the active application. Click  to view context-sensitive information.</li></ol>

## Customer support

Description	Where to find (North America)	Where to find (rest of world)
<b>Telephone support</b>	<p>Call us at</p> <ul style="list-style-type: none"> <li>• US: 1-800-332-4120               <ul style="list-style-type: none"> <li>– Monday–Friday (8:00 AM–11:00 PM ET), Saturday (Noon–6:00 PM ET)</li> </ul> </li> <li>• Canada: 1-800-539-6275               <ul style="list-style-type: none"> <li>– Support in English: Monday–Friday (8:00 AM–11:00 PM ET), Saturday (Noon–6:00 PM ET)</li> <li>– Support in French: Monday–Friday (9:00 AM–7:00 PM ET)</li> </ul> </li> <li>• Mexico: 01-800-253-9627               <ul style="list-style-type: none"> <li>– Monday–Friday (8:00 AM–8:00 PM ET)</li> </ul> </li> </ul> <p><b>Note:</b> Support numbers and times may change without notice. For the most recent telephone numbers available, see the printed warranty statement that came with your printer.</p>	<p>Telephone numbers and support hours vary by country or region.</p> <p>Visit our Web site at <a href="http://www.lexmark.com">www.lexmark.com</a>. Select a country or region, and then select the Customer Support link.</p> <p><b>Note:</b> For additional information about contacting Lexmark, see the printed warranty that came with your printer.</p>
<b>E-mail support</b>	<p>For e-mail support, visit our Web site: <a href="http://www.lexmark.com">www.lexmark.com</a>.</p> <ol style="list-style-type: none"> <li>1 Click <b>SUPPORT</b>.</li> <li>2 Click <b>Technical Support</b>.</li> <li>3 Select your printer family.</li> <li>4 Select your printer model.</li> <li>5 From the Support Tools section, click <b>e-Mail Support</b>.</li> <li>6 Complete the form, and then click <b>Submit Request</b>.</li> </ol>	<p>E-mail support varies by country or region, and may not be available in some instances.</p> <p>Visit our Web site at <a href="http://www.lexmark.com">www.lexmark.com</a>. Select a country or region, and then select the Customer Support link.</p> <p><b>Note:</b> For additional information about contacting Lexmark, see the printed warranty that came with your printer.</p>

## Limited Warranty

Description	Where to find (USA)	Where to find (rest of world)
<p>Limited Warranty Information</p> <p>Lexmark International, Inc. furnishes a limited warranty that this printer will be free of defects in materials and workmanship for a period of 12 months after the original date of purchase.</p>	<p>To view the limitations and conditions of this limited warranty, see the Statement of Limited Warranty included with this printer, or set forth at <a href="http://www.lexmark.com">www.lexmark.com</a>.</p> <ol style="list-style-type: none"> <li>1 Click <b>SUPPORT</b>.</li> <li>2 Click <b>Warranty Information</b>.</li> <li>3 Click <b>Statement of Limited Warranty for Inkjet &amp; All-In-One Printers</b>.</li> <li>4 Scroll through the Web page to view the warranty.</li> </ol>	<p>Warranty information varies by country or region. See the printed warranty that came with your printer.</p>

Record the following information (located on the store receipt and the back of the printer), and have it ready when you contact customer support so that they may serve you faster:

- Machine Type number
- Serial number

- Date purchased
- Store where purchased



# Setting up the printer

## Bypassing security warnings during software installation

Third-party applications, including antivirus, security, and firewall programs may alert you about the printer software being installed. For your printer to work properly, allow the printer software to be installed on your computer.

## Setting up the printer as a copier only

Use the following instructions if you do not want to connect the printer to a computer.

**Note:** If you want to connect the printer to a computer, use the setup documentation and the printer software CD that came with the printer.

- 1 Unpack the printer.

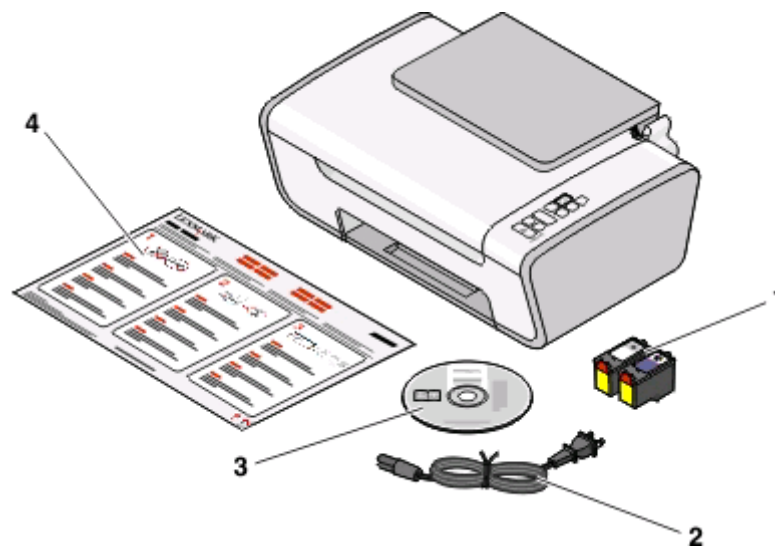

1	Print cartridges <b>Note:</b> Contents, such as the number of print cartridges, may vary.
2	Power cord
3	Printer software CD
4	Quick Setup sheet

2 Remove all tape and packing material from all areas of the printer.

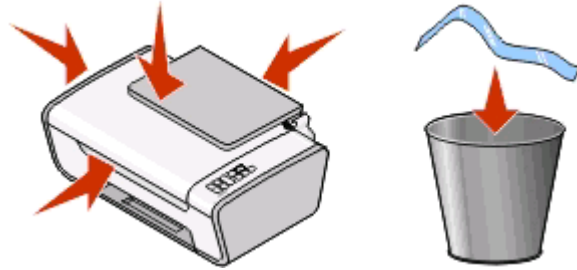

3 Extend the paper exit tray, and then raise the paper support.

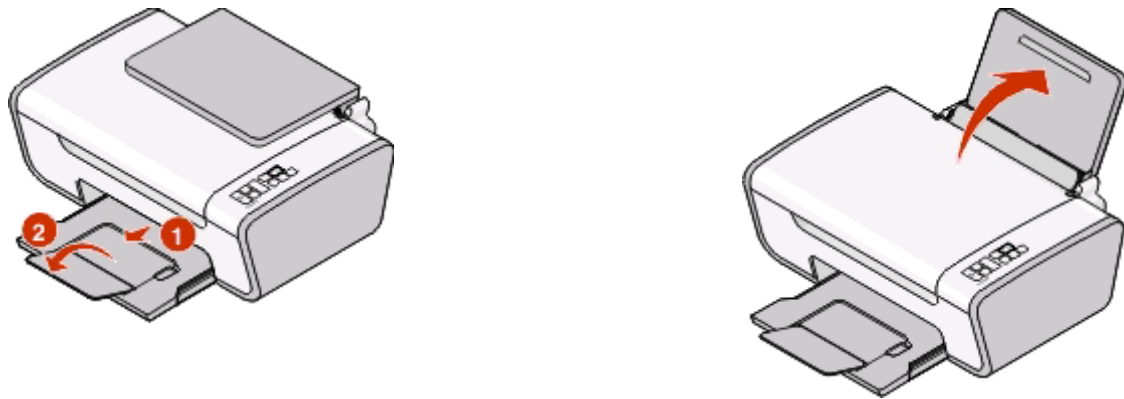

4 Extend the paper guides.

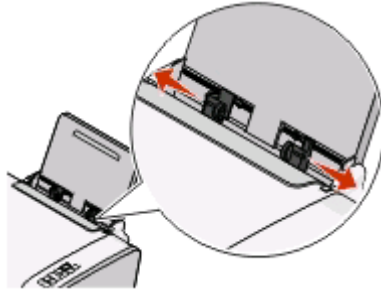

5 Connect the power cord, and then make sure the power is on.



6 Open the printer, and then press down on the levers.

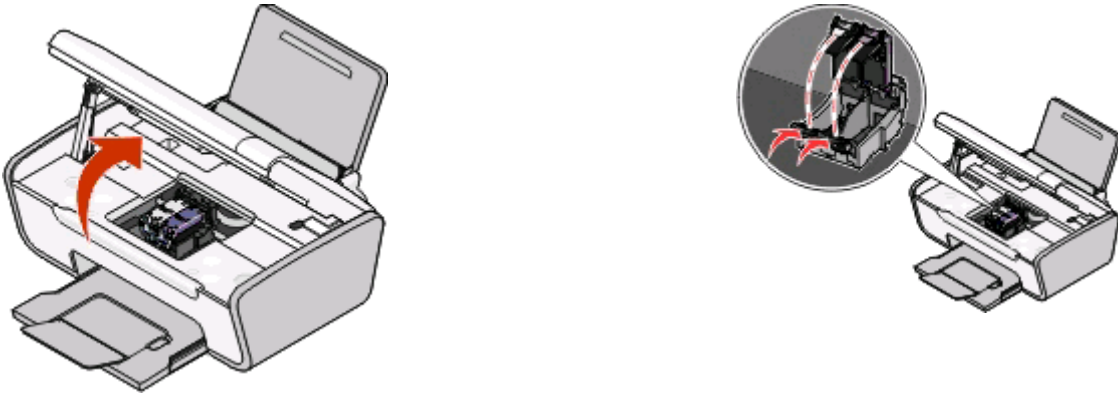

7 Remove the tape from the black cartridge, insert the cartridge in the left carrier, and then close the black cartridge carrier lid.

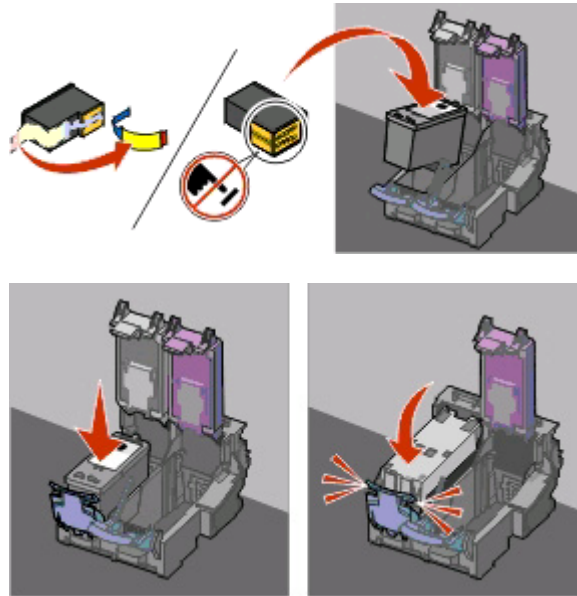

**8** Remove the tape from the color cartridge, insert the cartridge in the right carrier, and then close the color cartridge carrier lid.

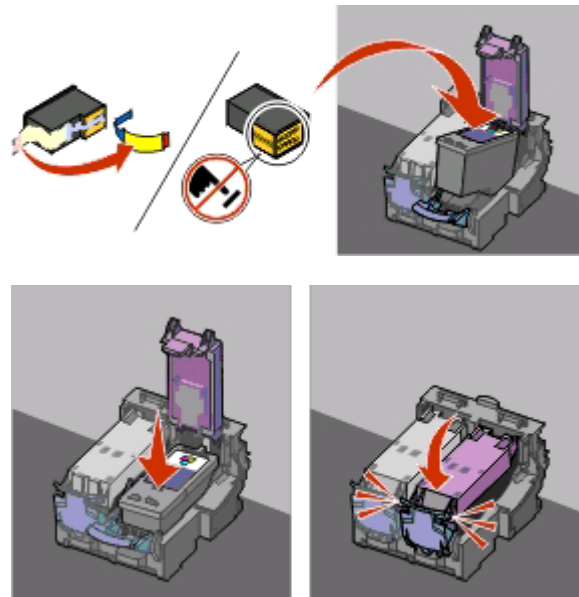

**9** Close the printer, and then load paper.



**10** Press and hold the  button for three seconds.

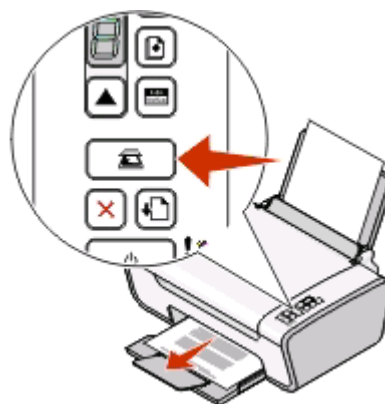



**Notes:**

- The alignment page may differ from the one shown.
- Streaks on the alignment page are normal, and do not indicate a problem.

## Understanding the parts of the printer

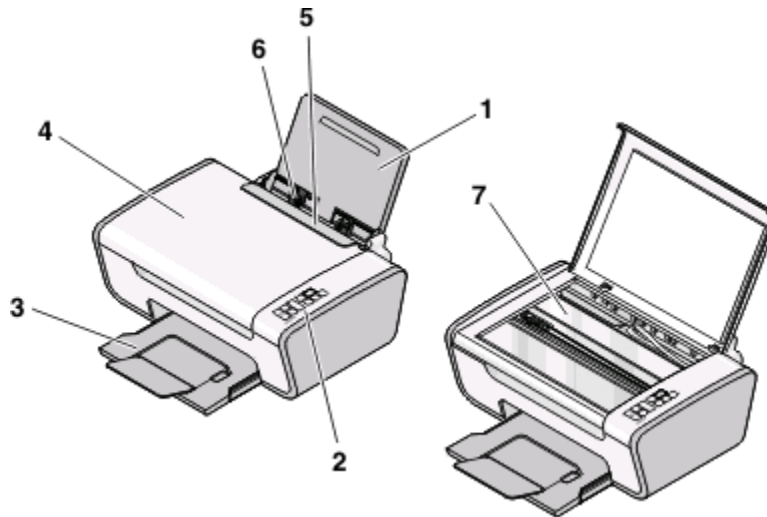



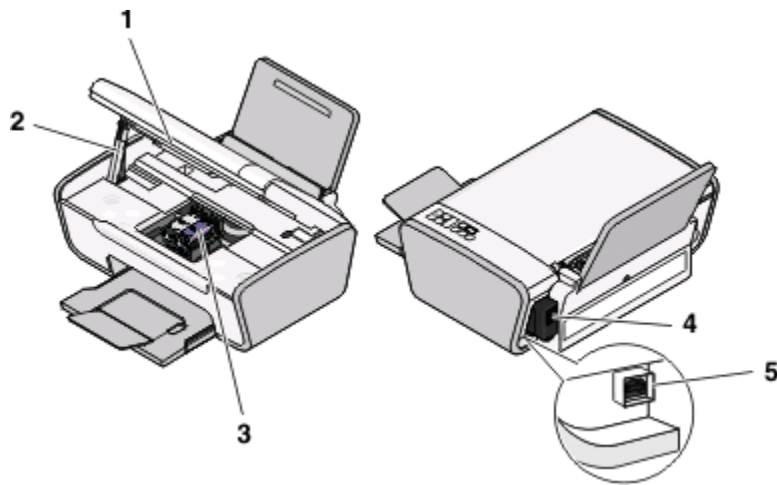



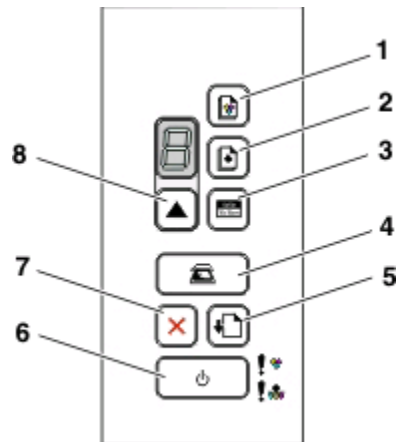

	Use the	To
<b>1</b>	Paper support	Load paper.
<b>2</b>	Printer control panel	Operate the printer.
<b>3</b>	Paper exit tray	Hold paper as it exits.
<b>4</b>	Top cover	Access the scanner glass.
<b>5</b>	Paper feed guard	Prevent small objects from falling inside the printer.
<b>6</b>	Paper guide	Keep paper straight when feeding.
<b>7</b>	Scanner glass	Copy, scan, fax, or remove an item.



	Use the	To
1	Scanner unit	Access the print cartridges.
2	Scanner support	Hold up the scanner unit.
3	Print cartridge carrier	Install, replace, or remove a print cartridge.
4	Power supply with port	Connect the printer to a power source.
5	USB port	Connect the printer to a computer using a USB cable. <b>Warning—Potential Damage:</b> Do not touch the USB port except when plugging in or removing a USB cable.



# Using the printer control panel



	Press	To
1		Start a color copy of a document or photo.
2		Start a black-and-white copy of a document or photo.
3		Start a 4 x 6-inch color photo copy.
4		Scan a document or photo to the computer.
5		Load or eject paper.
6		<ul style="list-style-type: none"> <li>• Turn the printer on or off.</li> <li>• Cancel a print, copy, or scan job in progress.</li> <li>• Reset the printer.</li> </ul>
7		Cancel a print, copy, or scan job in progress.
8		Set the number of copies.

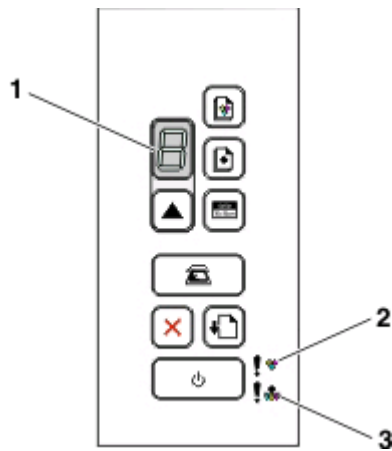



	Check	To
1	The display	Determine the number of copies to be printed.
2	 The light	<ul style="list-style-type: none"> <li>• Determine if the color print cartridge needs to be replaced.</li> <li>• Determine if the color print cartridge is missing or invalid.</li> </ul>
3	 The light	<ul style="list-style-type: none"> <li>• Determine if the black or photo print cartridge needs to be replaced.</li> <li>• Determine if the black or photo print cartridge is missing or invalid.</li> </ul>

# Understanding the printer software

## Installing printer software

### Using Windows

- 1 Close all open software programs.
- 2 Insert the printer software CD.
- 3 From the main installation screen, click **Install**.
- 4 Follow the instructions on the screens.

### Using Macintosh

- 1 Close all open software applications.
- 2 Insert the printer software CD.
- 3 From the Finder desktop, double-click the printer CD icon that automatically appears.
- 4 Double-click the **Install** icon.
- 5 Follow the instructions on the screens.

### Using the World Wide Web

- 1 Go to the Lexmark Web site at **www.lexmark.com**.
- 2 From the home page, navigate through the menu selection, and then click **Drivers & Downloads**.
- 3 Choose the printer and the printer driver for your operating system.
- 4 Follow the instructions on the screens to download the driver and install the printer software.

## Installing the optional XPS driver (Windows Vista users only)

The XML Paper Specification (XPS) driver is an optional printer driver designed to make use of the advanced XPS color and graphics features that are available only for Windows Vista users. To use XPS features, you must install the XPS driver as an additional driver after you install the regular printer software.

#### Notes:

- Before installing the XPS driver, you must install the printer on your computer.
- Before installing the XPS driver, you must install the Microsoft QFE Patch and then extract the driver files from the installation software CD. To install the patch, you must have administrator privileges on the computer.

To install the Microsoft QFE Patch and extract the driver:

- 1 Insert the installation software CD, and then click **Cancel** when the Setup Wizard appears.
- 2 Click  → **Computer**.
- 3 Double-click the CD or DVD drive icon, and then double-click **Drivers**.
- 4 Double-click **xps**, and then double-click the **setupxps** file.

XPS driver files are copied to your computer, and any required Microsoft XPS files are launched. Follow the instructions on the screen to finish installing the patch.

To install the XPS driver:

- 1 Click  → **Control Panel**.
- 2 Under Hardware and Sound, click **Printer**, and then click **Add a Printer**.
- 3 From the Add Printer dialog, click **Add a local printer**.
- 4 From the "Use an existing port" drop-down menu, select **Virtual printer port for USB**, and then click **Next**.
- 5 Click **Have disk**.

The Install From Disk dialog appears.

- 6 Click **Browse**, and then navigate to the XPS driver files on your computer:
  - a Click **Computer**, and then double-click **(C:)**.
  - b Double-click **Drivers**, and then double-click **Printer**.
  - c Double-click the folder that has your printer model number, and then double-click **Drivers**.
  - d Double-click **xps**, and then click **Open**.
  - e From the **Install From Disk** dialog, click **OK**.
- 7 Click **Next** on the two additional dialogs that appear.

For more information on the XPS driver, see the XPS **readme** file on the installation software CD. The file is located in the xps folder with the setupxps batch file (D:\Drivers\xps\readme).

## Using the Windows printer software

When you set up the printer using the installation software CD, all the necessary software was installed. You may have chosen to install some additional programs. The following table provides an overview of various software programs and what they can help you do.

If you did not install these additional programs during initial installation, then reinsert the installation software CD, run the installation software, and then select **Install Additional Software** from the Software Already Installed screen.

**Note:** Your printer may not come with some of these programs or some of the functions of these programs, depending on the features of the printer that you purchased.

Use the	To
Lexmark™ Productivity Studio or Lexmark FastPics	<ul style="list-style-type: none"><li>• Scan, copy, fax, e-mail, or print a photo or document.</li><li>• Transfer photos.</li><li>• Make photo greeting cards.</li><li>• Adjust settings for the printer.</li></ul>

Use the	To
Lexmark Fax Solutions Software	<ul style="list-style-type: none"> <li>• Send a fax.</li> <li>• Receive a fax</li> <li>• Add, edit, or delete contacts in the built-in phone book.</li> <li>• Access the Lexmark Fax Setup Utility. Use the Lexmark Fax Setup Utility to set the Speed Dial and Group Dial numbers, set Ringing and Answering, and print fax history and status reports.</li> </ul>
Printing Preferences	<p>When you select <b>File → Print</b> with a document open, a Printing Preferences dialog appears. The dialog lets you select options for the print job such as the following:</p> <ul style="list-style-type: none"> <li>• Select the number of copies to be printed.</li> <li>• Print two-sided copies.</li> <li>• Select the paper type.</li> <li>• Add a watermark.</li> <li>• Enhance images.</li> <li>• Save settings.</li> </ul>
Lexmark Wireless Setup Utility	<ul style="list-style-type: none"> <li>• Set up the wireless printer on a wireless network.</li> <li>• Change the wireless settings of the printer.</li> </ul>

## Using the Macintosh printer software

Use the	To
Print dialog	Adjust the print settings and schedule print jobs.
Printer Services dialog	<ul style="list-style-type: none"> <li>• Access the printer utility.</li> <li>• Troubleshoot.</li> <li>• Order ink or supplies.</li> <li>• Contact Lexmark.</li> <li>• Check the printer software version installed on the computer.</li> </ul>

Applications are also installed with the printer software during installation. These applications are saved in the printer folder that appears on the Finder desktop after installation.

- 1 From the Finder desktop, double-click the printer folder.
- 2 Double-click the icon of the application that you want to use.

Use the	To
Lexmark All-In-One Center	<ul style="list-style-type: none"> <li>• Scan photos and documents.</li> <li>• Customize settings for scan jobs.</li> </ul>
Lexmark Fax Setup Utility	<ul style="list-style-type: none"> <li>• Customize settings for fax jobs.</li> <li>• Create and edit the Speed Dial list.</li> </ul>

Use the	To
Lexmark Network Card Reader	<ul style="list-style-type: none"> <li>• View the contents of a memory device inserted into a network printer.</li> <li>• Transfer photos and documents from a memory device to the computer over a network.</li> </ul>
Lexmark Printer Utility	<ul style="list-style-type: none"> <li>• Get help with cartridge installation.</li> <li>• Print a test page.</li> <li>• Print an alignment page.</li> <li>• Clean the print cartridge nozzles.</li> <li>• Order ink or supplies.</li> <li>• Register the printer.</li> <li>• Contact customer support.</li> </ul>
Lexmark Wireless Setup Assistant	Set up the printer on a wireless network.

**Note:** Your printer may not come with these applications, depending on the features of the printer that you purchased.

# Loading paper and original documents

## Loading paper

- 1 Make sure:
  - You use paper designed for inkjet printers.
  - If you are using photo, glossy, or heavyweight matte paper, you load it with the glossy or printable side facing you. (If you are not sure which side is the printable side, see the instructions that came with the paper.)
  - The paper is not used or damaged.
  - If you are using specialty paper, you follow the instructions that came with it.
  - You do not force paper into the printer.
- 2 Before loading paper the first time, slide the paper guides out toward the edges of the paper support.
- 3 Load the paper vertically in the center of the paper support, and adjust the paper guides to rest against the edges of the paper.



**Note:** To avoid paper jams, make sure the paper does not buckle when you adjust the paper guides.

## Loading various paper types

Load up to	Make sure
100 sheets of plain paper	<ul style="list-style-type: none"><li>• The paper is designed for use with inkjet printers.</li><li>• The paper is loaded in the center of the paper support.</li><li>• The paper guides rest against the edges of the paper.</li></ul>
25 sheets of heavyweight matte paper 25 sheets of photo paper 25 sheets of glossy paper	<ul style="list-style-type: none"><li>• The glossy or printable side of the paper faces you. (If you are not sure which side is the printable side, then see the instructions that came with the paper.)</li><li>• The paper is loaded in the center of the paper support.</li><li>• The paper guides rest against the edges of the paper.</li></ul> <p><b>Note:</b> Photos require more drying time. Remove each photo as it exits, and then allow it to dry to avoid ink smudging.</p>

Load up to	Make sure
10 envelopes	<ul style="list-style-type: none"> <li>• The print side of the envelopes faces you.</li> <li>• The stamp location is in the upper left corner.</li> <li>• The envelopes are designed for use with inkjet printers.</li> <li>• The envelopes are loaded in the center of the paper support.</li> <li>• The paper guides rest against the edges of the envelopes.</li> </ul> <p><b>Warning—Potential Damage:</b> Do not use envelopes that have metal clasps, string ties, or metal folding bars.</p> <p><b>Notes:</b></p> <ul style="list-style-type: none"> <li>– Do not load envelopes with holes, perforations, cutouts, or deep embossing.</li> <li>– Do not use envelopes that have exposed flap adhesive.</li> <li>– Envelopes require more drying time. Remove each envelope as it exits, and then allow it to dry to avoid ink smudging.</li> </ul> 
25 sheets of labels	<ul style="list-style-type: none"> <li>• The print side of the label sheets faces you.</li> <li>• The top of the label sheets feeds into the printer first.</li> <li>• The adhesive on the labels does not extend to within 1 mm of the edge of the label sheets.</li> <li>• You use full label sheets. Partial sheets (with areas exposed by missing labels) may cause labels to peel off during printing, resulting in a paper jam.</li> <li>• The label sheets are loaded in the center of the paper support.</li> <li>• The paper guides rest against the edges of the label sheets.</li> </ul> <p><b>Note:</b> Labels require more drying time. Remove each sheet of labels as it exits, and then allow it to dry to avoid ink smudging.</p>
50 transparencies	<ul style="list-style-type: none"> <li>• The rough side of the transparencies faces you.</li> <li>• If the transparencies have a removable strip, each strip faces away from you and down toward the printer.</li> <li>• The transparencies are loaded in the center of the paper support.</li> <li>• The paper guides rest against the edges of the transparencies.</li> </ul> <p><b>Notes:</b></p> <ul style="list-style-type: none"> <li>• Transparencies with paper backing sheets are not recommended.</li> <li>• Transparencies require more drying time. Remove each transparency as it exits, and then allow it to dry to avoid ink smudging.</li> </ul>

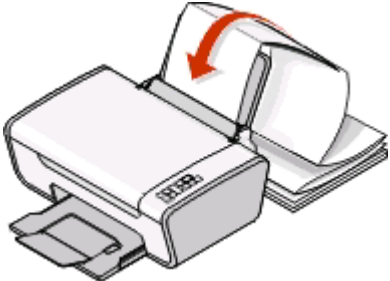
Load up to	Make sure
10 iron-on transfers	<ul style="list-style-type: none"> <li>• You follow the loading instructions that came with the iron-on transfers.</li> <li>• The print side of the transfers faces you.</li> <li>• The transfers are loaded in the center of the paper support.</li> <li>• The paper guides rest against the edges of the transfers.</li> </ul> <p><b>Note:</b> For best results, load transfers one at a time.</p>
25 greeting cards 25 index cards 25 photo cards 25 postcards	<ul style="list-style-type: none"> <li>• The print side of the cards faces you.</li> <li>• The cards are loaded in the center of the paper support.</li> <li>• The paper guides rest against the edges of the cards.</li> </ul>  <p><b>Note:</b> Photo cards require more drying time. Remove each photo card as it exits, and then allow it to dry to avoid ink smudging.</p>
custom-size paper	<ul style="list-style-type: none"> <li>• The print side of the paper faces you.</li> <li>• The paper size fits within these dimensions:                Width:                – 76.2–215.9 mm                – 3.0–8.5 inches                Length:                – 127.0–355.6 mm                – 5.0–17.0 inches</li> <li>• The paper is loaded in the center of the paper support.</li> <li>• The paper guides rest against the edges of the paper.</li> </ul>
banner paper	 <ul style="list-style-type: none"> <li>• You remove all the paper from the paper support before loading the banner paper.</li> <li>• You tear off only the number of pages needed to print the banner.</li> <li>• You place the required stack of banner paper behind the printer, and then feed in the first sheet.</li> <li>• The leading edge of the banner paper feeds into the printer first.</li> <li>• The paper is loaded in the center of the paper support.</li> <li>• The paper guides rest against the edges of the paper.</li> </ul>



# Loading original documents on the scanner glass

You can scan and then print photos, text documents, magazine articles, newspapers, and other publications. You can scan a document for faxing.

**Note:** The maximum scan area for the scanner glass is 216 x 297 mm (8.5 x 11.7 in.).

- 1 Open the top cover.

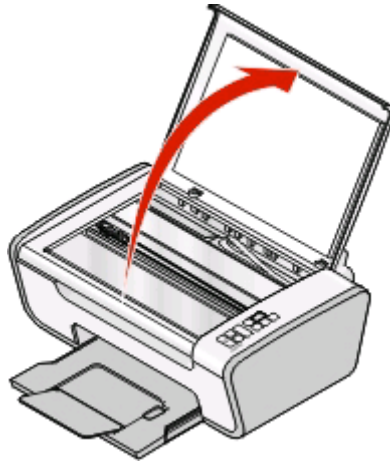

- 2 Place the original document or item facedown on the scanner glass in the lower right corner.

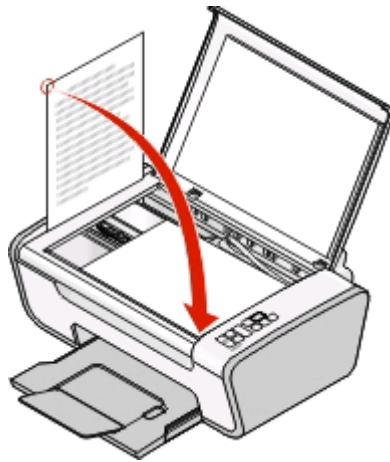

**Note:** Photos should be loaded as shown.

**3** Close the top cover to avoid dark edges on the scanned image.

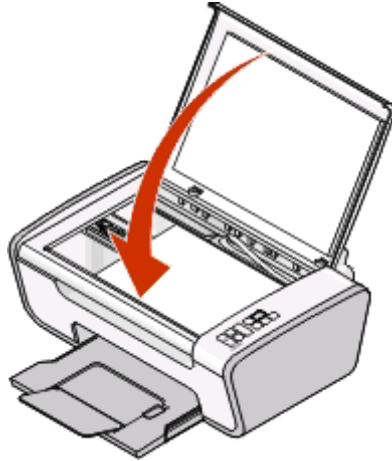

# Printing

## Printing basic documents

### Printing a document

- 1 Load the paper.



- 2 Do one of the following to print:

#### Using Windows

- a With a document open in a Windows program , click **File → Print**.
- b Click **Properties, Preferences, Options, or Setup**.
- c Select the print quality, the number of copies to print, the type of paper to be used, and how the pages should print.
- d Click **OK** to close any printer software dialogs.
- e Click **OK** or **Print**.

#### Using Macintosh

- a With a document open in a Macintosh application, click **File → Print**.
- b From the Printer pop-up menu, choose the printer.
- c From the print options pop-up menu, choose the print quality, the number of copies to print, the type of paper to be used, and how the pages should print.
- d Click **Print**.

### Printing Web pages

If you chose to install the Lexmark Toolbar software for your Web browser, then you can use it to create a printer-friendly version of any Web page.

#### Notes:

- For Windows, the software supports Microsoft Internet Explorer 5.5 or later or a compatible version of Firefox.
- For Macintosh, the software supports a compatible version of Firefox.

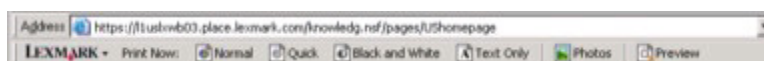

- 1 Load paper.
- 2 Open a Web page using a supported browser.
- 3 Select a print option to print the page.  
You can also adjust settings or preview the page before printing.

## Printing multiple copies of a document

### Using Windows

- 1 With a document open, click **File → Print**.
- 2 Click **Properties, Preferences, Options, or Setup**.
- 3 From the Copies section of the Print Setup tab, enter the number of copies that you want to print.
- 4 Click **OK** to close any printer software dialogs.
- 5 Click **OK** or **Print**.

### Using Macintosh

- 1 With a document open, click **File → Print**.
- 2 From the Printer pop-up menu, choose the printer.
- 3 In the Copies field, enter the number of copies that you want to print.
- 4 Click **Print**.

## Collating printed copies

If you print multiple copies of a document, you can choose to print each copy as a set (collated) or to print the copies as groups of pages (not collated).

### Collated



### Not collated



### Using Windows

- 1 With a document open, click **File → Print**.
- 2 Click **Properties, Preferences, Options, or Setup**.
- 3 From the Copies section of the Print Setup tab, enter the number of copies that you want to print, and then select **Collate Copies**.
- 4 Click **OK** to close any printer software dialogs.
- 5 Click **OK** or **Print**.

**Note:** The collate option is available only when you are printing multiple copies.

## Using Macintosh

- 1 With a document open, click **File → Print**.
- 2 In the Copies field, enter the number of copies that you want to print, and then select **Collated**.
- 3 Click **Print**.

**Note:** To prevent smudging when printing photos, remove each photo as it exits the printer, and then let it dry before stacking.

## Printing the last page first (reverse page order)

### Using Windows

- 1 With a document open, click **File → Print**.
- 2 Click **Properties, Preferences, Options, or Setup**.
- 3 From the Copies section of the Print Setup tab, select **Print Last Page First**.
- 4 Click **OK** to close any printer software dialogs.
- 5 Click **OK** or **Print**.

### Using Macintosh

- 1 With a document open, choose **File → Print**.
- 2 From the Printer pop-up menu, choose the printer.
- 3 From the print options pop-up menu, choose **Paper Handling**.
- 4 From the Paper Handling menu, or from the Page Order pop-up menu, select a page order:
  - To print the last page first, select **Reverse page order** or **Reverse**.
  - To print the first page first, clear the **Reverse page order** or **Reverse** check box.
- 5 Click **Print**.

## Printing multiple pages on one sheet (N-Up)

### Using Windows

- 1 With a document open, click **File → Print**.
- 2 Click **Properties, Preferences, Options, or Setup**.
- 3 From the **Advanced** tab, select **N-Up** under the Layout drop-down menu.
- 4 Select the number of page images to print on each page.  
If you want each page image to be surrounded by a border, then select **Print Page Borders**.
- 5 Click **OK** to close any printer software dialogs.
- 6 Click **OK** or **Print**.

## Using Macintosh

- 1 With a document open, choose **File → Print**.
- 2 From the Printer pop-up menu, choose the printer.
- 3 If necessary, click the disclosure triangle.
- 4 From the print options pop-up menu, choose **Copies & Pages**, and then click **Page Setup**.
- 5 From the Paper Size pop-up menu, choose a paper size.
- 6 Choose an orientation, and then click **OK**.
- 7 From the print options pop-up menu, choose **Layout**.
  - From the Pages per Sheet pop-up menu, choose the number of page images that you want to print on one sheet.
  - From the Layout Direction menu, choose a layout direction.
  - If you want to print a border around each page image, then choose an option from the Border pop-up menu.
- 8 Click **Print**.

## Pausing print jobs

### Using the printer folder in Windows

- 1 Do one of the following:

#### In Windows Vista

- a Click .
- b Click **Control Panel**.
- c Under **Hardware and Sound**, click **Printer**.

#### In Windows XP

- a Click **Start**.
- b Click **Printers and Faxes**.

#### In Windows 2000

- a Click **Start**.
- b Click **Settings → Printers**.

- 2 Right-click the printer, and then select **Pause Printing**.

### Using the taskbar in Windows

- 1 Double-click the printer icon in the taskbar.
- 2 Right-click the document name, and then select **Pause**.

## Using Macintosh

- 1 While the document is printing, click the printer icon in the Dock.  
The print queue dialog appears.
- 2 Do one of the following:
  - If you want to pause a particular print job, choose the document name, and then click **Hold**.
  - If you want to pause all print jobs in the queue, click **Pause Printer** or **Stop Jobs**, depending on the operating system version that you are using.

## Canceling print jobs

### Using the printer control panel

Press .

### Using the printing status window of the printer

The printing status window automatically opens at the bottom-right part of your screen when you send a print job. Click **Cancel Printing** to cancel the print job.

### Using the printer folder in Windows

- 1 Do one of the following:

#### In Windows Vista

- a Click .
- b Click **Control Panel**.
- c Under Hardware and Sound, click **Printer**.

#### In Windows XP

- a Click **Start**.
- b Click **Printers and Faxes**.

#### In Windows 2000

- a Click **Start**.
- b Click **Settings → Printers**.

- 2 Right-click the printer name, and then select **Open**.
- 3 Do one of the following:
  - If you want to cancel a particular print job, right-click the document name, and then select **Cancel**.
  - If you want to cancel all print jobs in the queue, click **Printer → Cancel All Documents**.

## Using the taskbar in Windows

- 1 Double-click the printer icon in the taskbar.
- 2 Do one of the following:
  - If you want to cancel a particular print job, right-click the document name, and then select **Cancel**.
  - If you want to cancel all print jobs in the queue, click **Printer → Cancel All Documents**.

## Using Macintosh

- 1 While the document is printing, click the printer icon in the Dock.
- 2 From the print queue dialog, choose the job that you want to cancel, and then click **Delete**.

# Printing specialty documents

## Choosing compatible specialty paper types

- **Heavyweight matte paper**—A photo paper with a matte finish used for printing high-quality graphics.
- **Photo/Glossy paper**—Photo paper with a special coating. It is used specifically for printing photos with crisp, sharp images.
- **Lexmark Photo Paper**—An outstanding "everyday" heavyweight inkjet photo paper designed for use with Lexmark printers, but compatible with all brands of inkjet printers. Although inexpensive, it offers excellent image quality and outstanding value.
- **Lexmark Premium Photo Paper**—A high-gloss, heavyweight quality photo paper specifically designed to work with Lexmark's evercolor™ inks for eye-catching, color-rich results. It is great for those special photos to be framed, placed in an album, or shared with friends and family.
- **Lexmark PerfectFinish™ Photo Paper**—A high-quality photo paper specifically designed for Lexmark inkjet printers, but compatible with all inkjet printers. It is used specifically for printing professional quality photos with a glossy finish. It is best when used with genuine Lexmark evercolor 2 ink, providing photos that are fade- and water-resistant.
- **Transparency**—A clear, plastic media primarily used for overhead projectors.
- **Card stock**—A very thick paper used for printing sturdier items, such as greeting cards.
- **Iron-On transfer**—A type of media that has a reverse image printed on it that can be ironed onto fabric.

## Printing photos using printer software

- 1 Load photo paper with the glossy or printable side facing you. (If you are not sure which side is the printable side, then see the instructions that came with the paper.)
- 2 Print the photo:

### Using Windows

- a Do one of the following:
  - In Windows Vista, click .
  - In Windows XP and earlier, click **Start**.
- b Click **All Programs** or **Programs**, and then select the printer program folder from the list.



- c** Select **Lexmark Productivity Studio**.

**Note:** This program may not appear in your printer program folder, depending on whether you chose to install it with the printer software during installation.

- d** Open the photo that you want to print.
- e** Follow the instructions on the computer screen to edit and print photos. You may also view the Help associated with the program.

## Using Macintosh

- a** With a photo open, choose **File → Print**.
- b** From the Printer pop-up menu, choose the printer you want to use.
- c** If necessary, click **Advanced**.
- d** From the print options pop-up menu, choose **Print Settings** or **Quality & Media**, depending on your operating system.
  - From the Paper Type pop-up menu, choose a paper type.
  - From the Print Quality menu, choose **Photo** or **Best**.
- e** From the print options pop-up menu, choose **Paper Handling**.
- f** From the “Destination Paper Size” section, select **Scale to fit paper size**.
- g** From the Paper Size pop-up menu, choose the paper size you want.
- h** Click **Print**.

## Printing envelopes

- 1** Load the envelopes in the printer.



- 2** Send the print job:

## Using Windows

- a** With a document open, click **File → Print**.
- b** Click **Properties, Preferences, Options, or Setup**.
- c** From the Media Type list of the Print Setup tab, select **Plain**.
- d** From the Paper Size list, select the envelope size.

**Note:** To print on a custom-size envelope, select **Custom Size**, and then specify the height and width of the envelope.
- e** Select **Portrait** or **Landscape** orientation.
- f** Click **OK** to close any printer software dialogs.
- g** Click **OK** or **Print**.

## Using Macintosh

- a** With a document open, choose **File → Print**.
- b** From the Printer pop-up menu, choose the printer.
- c** If necessary, click the disclosure triangle.
- d** From the print options pop-up menu, choose **Copies & Pages**, and then click **Page Setup**.
- e** From the Paper Size pop-up menu, choose the envelope size. If no size matches the size of the envelope, then set a custom size.
- f** Select an orientation, and then click **OK**.
- g** Click **Print**.

### Notes:

- Most envelopes use landscape orientation.
- Make sure the same orientation is also selected in the software application.

## Printing labels

- 1** Load the label sheets in the printer.
- 2** Send the print job:

## Using Windows

- a** With a document open, click **File → Print**.
- b** Click **Properties, Preferences, Options, or Setup**.
- c** From the Paper Size drop-down menu of the Print Setup tab, choose a paper size that matches the size of the label sheet. If no paper size matches the label sheet size, then set a custom size.  
If necessary, choose the appropriate type of paper from the Media Type drop-down menu.
- d** Click **OK** to close any printer software dialogs.
- e** Click **OK** or **Print**.

## Using Macintosh

- a** With a document open, choose **File → Print**.
- b** From the Printer pop-up menu, choose the printer.
- c** If necessary, click the disclosure triangle.
- d** From the print options pop-up menu, choose **Copies & Pages**, and then click **Page Setup**.
- e** From the Paper Size pop-up menu, choose a size that matches the size of the label sheet. If no paper size matches the label sheet size, then set a custom size.
- f** Choose an orientation, and then click **OK**.
- g** From the print options pop-up menu, choose **Print Settings** or **Quality & Media**, depending on your operating system.
  - From the Paper Type pop-up menu, choose the appropriate type of paper.
  - From the Print Quality menu, choose a print quality other than Quick Print.
- h** Click **Print**.

## Tips on loading label sheets

- Make sure the top of the label sheet feeds into the printer first.
- Make sure the adhesive on the labels does not extend to within 1 mm of the edge of the label sheet.
- Make sure the paper guide or paper guides rest against the edges of the label sheet.
- Use full label sheets. Partial sheets (with areas exposed by missing labels) may cause labels to peel off during printing, resulting in a paper jam.

**Note:** Labels require more drying time. Remove each label sheet as it exits, and then allow it to dry to avoid ink smudging.

## Printing on custom-size paper

Before beginning these instructions, load the custom-size paper in the printer. For more information, see the “Loading Paper” chapter.

### Using Windows

- 1 With a document open, click **File → Print**.
- 2 Click **Properties, Preferences, Options, or Setup**.  
The Print Setup tab appears.
- 3 In the Paper Options section, from the “Paper size” list, select **Custom Size**.  
The Define Custom Paper Size dialog appears.
- 4 Set the paper size.
- 5 Select the measurement units to use (inches or millimeters).
- 6 Click **OK** to close any printer software dialogs that are open.
- 7 Print the document.

### Using Macintosh

- 1 With a document open, choose **File → Print**.
- 2 From the printer pop-up menu, choose the printer.
- 3 If necessary, click the disclosure triangle.
- 4 From the print options pop-up menu, choose **Copies & Pages** and then click **Page Setup**.
- 5 From the Paper Size pop-up menu, choose **Manage Custom Sizes**.
- 6 Select a custom size:
  - a In the Page Size section, type the Width and Height of the paper.
  - b From the Printer Margins pop-up menu, choose the printer. The margins are set by the printer.  
If you want to set the margins, then choose **User defined**, and then type the margins in the Printer Margins section.
  - c From the custom sizes list on the left of the dialog, double-click **Untitled**, and then type a name for the custom paper size you set.
  - d Click **OK**.

- 7 Open the Paper Size pop-up menu again, and then choose the name of the custom paper size you added in step 6c.
- 8 Click **OK**.
- 9 Click **Print**.

## Printing other specialty documents

When you installed the printer driver, some printer software was installed that may help you print specialty documents such as booklets, posters, iron-on transfers, transparencies, and banners. For information about printing these documents, see the Help installed with the programs or applications you choose to use.

### Using Windows

- 1 Do one of the following:
  - In Windows Vista, click  → **All Programs**, and then select the printer program folder from the list.
  - In Windows XP, click **Start** → **Programs or All Programs**, and then select the printer program folder from the list.
- 2 Click the program that you want to use.

### Using Macintosh

- 1 From the Finder desktop, double-click the printer folder.  
If the printer folder is not found on the desktop:
  - a Go to the Mac OS X drive where the printer software was installed.
  - b Choose **Library** → **Printers** → **YYYY** → **Lexmark**, and then select your printer model.  
YYYY is the year that the printer was released.
- 2 Double-click the application that you want to use.

## Saving and deleting print settings

### Using Windows

- 1 With a document open, click **File** → **Print**.
- 2 Click **Properties**, **Preferences**, **Options**, or **Setup**.
- 3 Make adjustments to the settings.
- 4 Click **Profiles**, and then click **Save your current settings**.
- 5 Select an empty location for your setting, and then assign a name.  
**Note:** The first location contains Factory Default Settings, which cannot be changed or deleted.
- 6 Click **Save**.
- 7 Close all open software dialogs.

**Notes:**

- To retrieve your print settings, click **Profiles → Restore a Profile**, and then select the name of the profile that you want to use.
- To delete a setting, click **Profiles → Delete Profiles**. Select the setting that you want to delete, and then click **Delete**.



## Using Macintosh

The Presets pop-up menu lets you save the print settings you use often. When print settings are saved into a Preset, there is no need to adjust the print settings for every print job.

- 1** With a document open, click **File → Print**.
- 2** From the print options pop-up menu, choose and adjust the settings.
- 3** From the Presets pop-up menu, choose **Save As**.  
The Save Preset dialog appears.
- 4** Type a name for the Preset.
- 5** Click **OK**.

# Copying

## Making a copy

- 1 Load paper.
- 2 Load an original document facedown on the scanner glass.
- 3 If you want to print more than one copy, then press ▲ until the number of copies that you want appears on the display.
- 4 Press  to start a color copy or  to start a black-and-white copy.

## Copying 4 x 6 photos

- 1 Load a 4 x 6 in. (10 x 15 cm) photo card with the glossy or printable side facing you. (If you are not sure which side is the printable side, then see the instructions that came with the paper.)
- 2 Place a photo facedown on the scanner glass in the lower right corner.
- 3 If you want to print more than one copy, press ▲ until the number of copies that you want appears on the display.
- 4 Press .

# Scanning

## Scanning original documents

You can scan and then print photos, text documents, magazine articles, newspapers, and other publications. You can also scan a document for faxing.

- 1 Open the top cover, and then load an original document facedown on the scanner glass.

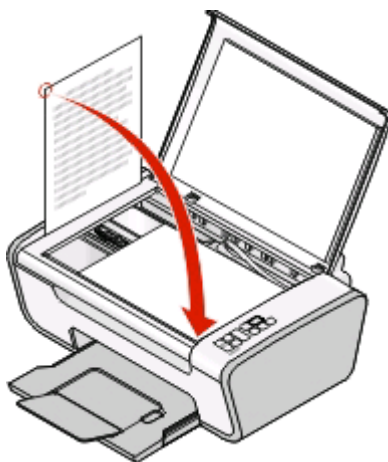

- 2 Close the top cover to avoid dark edges on the scanned image.
- 3 Make sure that the printer is connected to a computer, and that both the printer and the computer are on.
- 4 From the printer control panel, press .
- 5 If you are using a Macintosh operating system, click on the document or image preview and drag to select the part that you want to scan, and then click **Scan** from the Scan dialog on the computer screen.
- 6 If you want to save the scanned image, then from the software application, click **File → Save As**.
- 7 Enter the file name, format, and location where you want the scanned image saved.
- 8 Click **Save**.

## Canceling scan jobs

### Using the printer control panel

To cancel a job being scanned on the scanner glass, go to the printer control panel, and then press .

### Using Windows

To cancel a scan job started in the Lexmark Productivity Studio or Lexmark FastPics, open the software, and then follow the instructions on the screen.

## Using Macintosh

- 1 From the Finder desktop, double-click the printer folder.
- 2 Double-click the printer icon.
- 3 From the Progress dialog, click **Cancel**.



# Faxing

This chapter is applicable for **Windows users only**.

Before you send a fax, make sure:

- The printer is connected to a computer with an active fax modem, the computer is configured to fax, a phone line is connected to the computer, and both the printer and computer are on.
- The Lexmark Fax Solutions and Lexmark Productivity Studio software are installed on your computer. If you have not installed these additional programs during initial installation, reinsert the installation software CD, run the installation software, and then select **Install Additional Software** from the Software Already Installed screen.

## Sending a fax

- 1 Load an original document facedown on the scanner glass.
- 2 Do one of the following:
  - In Windows Vista, click  → **All Programs**, and then select the printer program folder.
  - In Windows XP, click **Start** → **Programs** or **All Programs**, and then select the printer program folder.
- 3 Click Lexmark **Productivity Studio**.
- 4 From the Welcome Screen, click **Fax**.
- 5 Select the **Document** option.
- 6 Click **Start**.
- 7 Enter the recipient information, and then click **Next**.

**Note:** A fax number can include up to 64 numbers, commas, periods, spaces, and/or these symbols: \* # + - ( ).
- 8 Enter the cover page information, and then click **Next**.
- 9 If there are any additional documents that you want to send with your fax, add these now, and then click **Next**.
- 10 To send your fax:
  - Immediately—Select the **Send now** option.
  - At a scheduled time:
    - a Select the **Delay sending until** option.
    - b Set a time and date.
- 11 If you want a paper copy of your fax, then select **Print a copy of your fax**.
- 12 Click **Send**.

## Receiving a fax automatically

- 1 Do one of the following:
  - In Windows Vista, click  → **All Programs**, and then select the printer program folder.
  - In Windows XP, click **Start** → **Programs** or **All Programs**, and then select the printer program folder.
- 2 Click Lexmark **Productivity Studio**.

- 3** From the Settings area in the left pane of the Welcome screen, click **Set up and manage faxes**.
- 4** From the "I Want To" menu, click **Adjust speed dial list and other fax settings**.
- 5** Click the **Ring and Answering** tab.
- 6** From the "Automatically answer incoming calls as a fax" area, select **On** from the Auto Answer drop-down list.
- 7** To turn the Auto Answer feature on and off at scheduled times, select the settings that you want from the drop-down lists.
- 8** To set the number of telephone rings before the printer automatically receives faxes, select a setting from the "Pick-up on the" drop-down list in the "Answering on your phone line type" area.
- 9** Click **OK** to save the settings.

# Maintaining the printer

## Maintaining print cartridges

### Installing print cartridges

- 1 Open the printer, and then press down on the cartridge carrier levers.

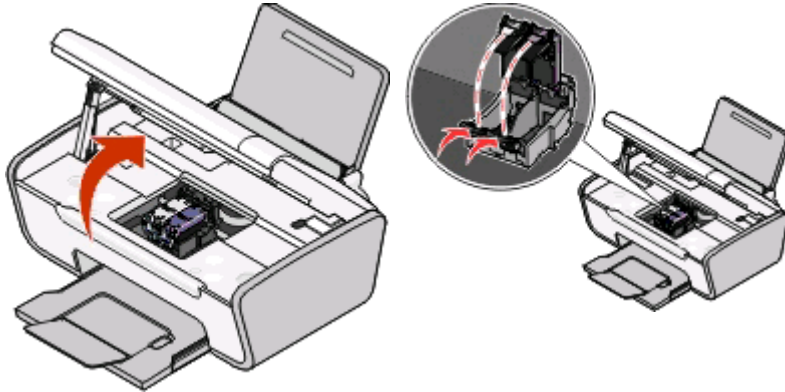

- 2 Remove the used print cartridge or cartridges.
- 3 If you are installing new print cartridges, remove the tape from the back and bottom of the black cartridge, insert the cartridge in the left carrier, and then close the black cartridge carrier lid.

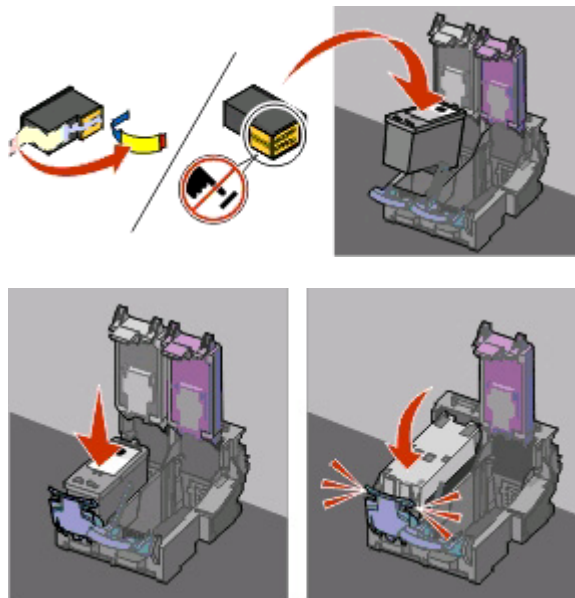

**Warning—Potential Damage:** Do *not* touch the gold contact area on the back or the metal nozzles on the bottom of the cartridge.

- 4 Remove the tape from the back and bottom of the color cartridge, insert the cartridge in the right carrier, and then close the color cartridge carrier lid.

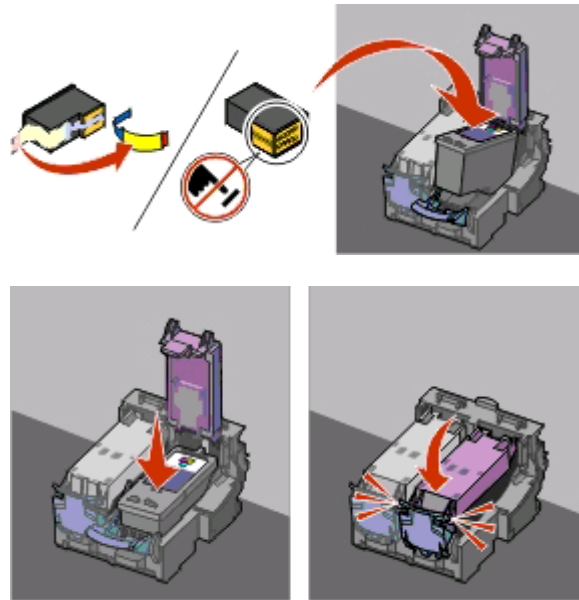

**Warning—Potential Damage:** Do *not* touch the gold contact area on the back or the metal nozzles on the bottom of the cartridge.

- 5 Close the printer, making sure to keep your hands out from underneath the scanner unit.

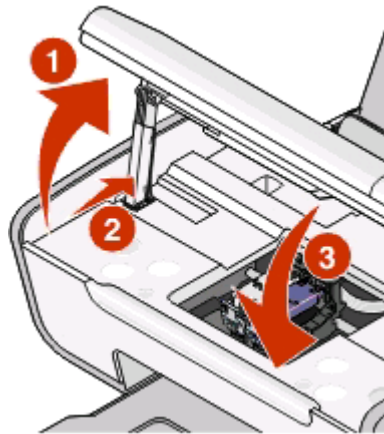

## Removing a used print cartridge

- 1 Make sure the printer is on.
- 2 Lift the scanner unit.

The print cartridge carrier moves and stops at the loading position, unless the printer is busy.

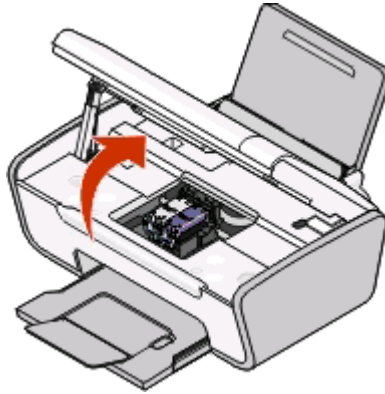

**3** Press down on the cartridge carrier latch to raise the cartridge carrier lid.

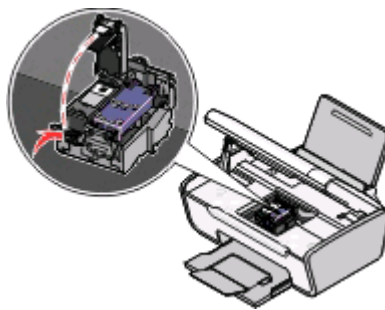

**4** Remove the used print cartridge.

**Note:** If you are removing both cartridges, repeat step 3 and step 4 for the second cartridge.

## Refilling print cartridges

The warranty does not cover repair of failures or damage caused by a refilled cartridge. Lexmark does not recommend use of a refilled cartridge. Refilling a cartridge can affect print quality and may cause damage to the printer. For best results, use Lexmark supplies.

## Using genuine Lexmark print cartridges

Lexmark printers, print cartridges, and photo paper are designed to perform together for superior print quality.

If you receive an **Out of Original Lexmark Ink** message, the original Lexmark ink in the indicated cartridge (s) has been depleted.

If you believe you purchased a new, genuine Lexmark print cartridge, but the **Out of Original Lexmark Ink** message appears:

- 1** Click **Learn More** on the message.
- 2** Click **Report a non-Lexmark print cartridge**.

To prevent the message from appearing again for the indicated cartridge(s):

- Replace your cartridge(s) with new Lexmark print cartridge(s).
- If you are printing from a computer, click **Learn more** on the message, select the check box, and then click **Close**.

- If you are using the printer without a computer, press **Cancel**.

Lexmark's warranty does not cover damage caused by non-Lexmark ink or print cartridges.

## Cleaning the print cartridge nozzles

### Using Windows

- 1 Load plain paper.
- 2 Do one of the following:
  - In Windows Vista, click .
  - In Windows XP and earlier, click **Start**.
- 3 Click **All Programs** or **Programs**, and then select the printer program folder from the list.
- 4 From the printer folder, click **Maintenance** → **Clean Cartridges**.
- 5 Click **Print**.  
A page prints, forcing ink through the print cartridge nozzles to clean them.
- 6 Print the document again to verify that the print quality has improved.

### Using Macintosh

- 1 Load plain paper.
- 2 From the Finder desktop, double click the printer folder.
- 3 Double-click the printer utility icon.
- 4 From the Maintenance tab, click **Clean Print Nozzles**.  
A page prints, forcing ink through the print cartridge nozzles to clean them.
- 5 Print the document again to verify that the print quality has improved.

If print quality has not improved, then try cleaning the nozzles up to two more times, or wipe the print cartridge nozzles and contacts.

## Wiping the print cartridge nozzles and contacts

- 1 Remove the print cartridge(s).
- 2 Dampen a clean, lint-free cloth with water, and then place the cloth on a flat surface.
- 3 Gently hold the nozzles against the cloth for about three seconds, and then wipe in the direction shown.



- Using another clean section of the cloth, gently hold the cloth against the contacts for about three seconds, and then wipe in the direction shown.

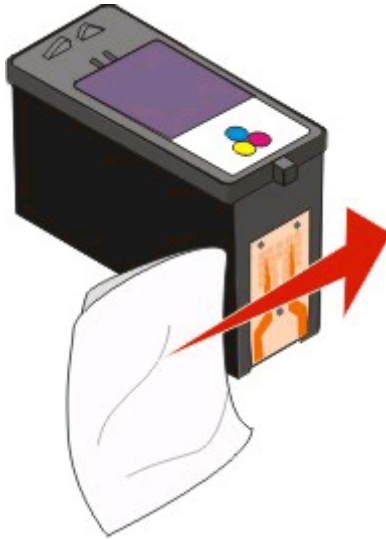

- With another clean section of the cloth, repeat step 3 and step 4, and then let the nozzles and contacts dry completely.
- Reinsert the print cartridge(s), and then print the document again.
- If the print quality does not improve, clean the print nozzles, and then try printing the document again.
- Repeat step 7 up to two more times.
- If print quality is still not satisfactory, replace the print cartridge(s).

## Preserving the print cartridges

- Keep new cartridges in their packaging until you are ready to install them.
- Do not remove a cartridge from the printer except to replace, clean, or store it in an airtight container. The cartridges do not print correctly if left exposed for an extended period of time.

## Cleaning the scanner glass

- Dampen a clean, lint-free cloth with water.
- Gently wipe the scanner glass clean.

**Note:** Make sure all ink or corrective fluid on a document is dry before placing the document on the scanner glass.

## Cleaning the exterior of the printer

- Make sure that the printer is turned off and unplugged from the wall outlet.

 **CAUTION—SHOCK HAZARD:** To avoid the risk of electric shock when cleaning the exterior of the printer, unplug the power cord from the wall outlet and disconnect all cables to the printer before proceeding.

- Remove paper from the paper support and paper exit tray.

3 Dampen a clean, lint-free cloth with water.

**Warning—Potential Damage:** Do not use household cleaners or detergents, as they may damage the finish of the printer.

4 Wipe only the outside of the printer, making sure to remove any ink residue that has accumulated on the paper exit tray.

**Warning—Potential Damage:** Using a damp cloth to clean the interior may cause damage to your printer.

5 Make sure the paper support and paper exit tray are dry before beginning a new print job.

## Ordering supplies

### Ordering print cartridges

Lexmark 2600 Series models

Item	Part number	Average cartridge standard page yield <sup>1</sup>
Black cartridge	14A	For page yield values, refer to <a href="http://www.lexmark.com/pageyields">www.lexmark.com/pageyields</a> .
Black cartridge <sup>2</sup>	14	
Color cartridge	15A	
Color cartridge <sup>2</sup>	15	
Photo cartridge	31	Not applicable

<sup>1</sup>Values obtained by continuous printing. Declared yield value in accordance with ISO/IEC 24711  
<sup>2</sup>Licensed Return Program Cartridge

Lexmark 2690 Series models

Item	Part number	Average cartridge standard page yield <sup>1</sup>
Black cartridge	4A	For page yield values, refer to <a href="http://www.lexmark.com/pageyields">www.lexmark.com/pageyields</a> .
Black cartridge <sup>2</sup>	4	
Color cartridge	5A	
Color cartridge <sup>2</sup>	5	
Photo cartridge	31	Not applicable

<sup>1</sup> Values obtained by continuous printing. Declared yield value in accordance with ISO/IEC 24711  
<sup>2</sup> Licensed Return Program Cartridge

### Ordering paper and other supplies

To purchase supplies or to locate a dealer near you, visit our Web site at [www.lexmark.com](http://www.lexmark.com).



For best results when printing photos or other high-quality images, use Lexmark Photo Paper or Lexmark PerfectFinish Photo Paper and Lexmark print cartridges.

Item	Description
Lexmark Photo Paper	<ul style="list-style-type: none"><li>• Letter</li><li>• A4</li><li>• 4 x 6 in.</li><li>• 10 x 15 cm</li></ul>
Lexmark PerfectFinish Photo Paper	<ul style="list-style-type: none"><li>• Letter</li><li>• A4</li><li>• 4 x 6 in.</li><li>• 10 x 15 cm</li><li>• L</li></ul>
USB cable	Part number 1021294

## Recycling Lexmark products

To return Lexmark products to Lexmark for recycling:

- 1 Visit our Web site at [www.lexmark.com/recycle](http://www.lexmark.com/recycle).
- 2 Follow the instructions on the computer screen.

# Troubleshooting

## Using the printer troubleshooting software (Windows only)

The Lexmark Service Center provides step-by-step troubleshooting help and contains links to printer maintenance tasks and customer support.

To open the Lexmark Service Center, use one of these methods:

Method 1	Method 2
If it appears on an error message dialog, click the <b>For additional assistance, use the Lexmark Service Center</b> link.	<ol style="list-style-type: none"><li>Do one of the following:<ul style="list-style-type: none"><li>In Windows Vista, click  → <b>All Programs</b>, and then select the printer program folder from the list.</li><li>In Windows XP, click <b>Start → Programs or All Programs</b>, and then select the printer program folder from the list.</li></ul></li><li>Select <b>Lexmark Service Center</b>.</li></ol>

## Setup troubleshooting



### Power button is not lit

These are possible solutions. Try one or more of the following:

#### PRESS POWER BUTTON

Make sure the printer is on by pressing .

#### DISCONNECT AND RECONNECT THE POWER CORD

- Press  to turn the printer off.
- Disconnect the power cord from the wall outlet, and then from the printer.
- Plug the cord all the way into the power supply on the printer.
- Plug the cord into an electrical outlet that other electrical devices have been using.
- Press  to turn the printer on.

## Software did not install

If you encountered problems while installing, or if your printer does not appear in the list in the Printers folder or as a printer option when sending a print job, you can try uninstalling and reinstalling the software.

These are some other possible solutions. Try one or more of the following:

### MAKE SURE YOUR OPERATING SYSTEM IS SUPPORTED



The following operating systems are supported: Windows Vista, Windows XP, Windows 2000 with Service Pack 3 or later, and Mac OS X version 10.3 or later.

### CHECK THAT YOUR COMPUTER MEETS THE MINIMUM SYSTEM REQUIREMENTS LISTED ON THE PRINTER BOX

### CHECK THE USB CONNECTION

- 1 Check the USB cable for any obvious damage. If the cable is damaged, use a new one.
- 2 Firmly plug the square end of the USB cable into the back of the printer.
- 3 Firmly plug the rectangular end of the USB cable into the USB port of the computer.  
The USB port is marked with the  USB symbol.

### RECONNECT THE POWER SUPPLY

- 1 Press  to turn the printer off.
- 2 Disconnect the power cord from the wall outlet.
- 3 Gently remove the power supply from the printer.
- 4 Reconnect the power supply to the printer.
- 5 Plug the power cord into the wall outlet.
- 6 Press  to turn the printer on.

### TEMPORARILY DISABLE SECURITY PROGRAMS IN WINDOWS BEFORE INSTALLING THE SOFTWARE

- 1 Close all open programs.
- 2 Disable any security programs.
- 3 Do one of the following:
  - In Windows Vista, click .
  - In Windows XP and earlier, click **Start**.
- 4 Click **Computer** or **My Computer**.
- 5 Double-click the CD or DVD drive icon.
- 6 If necessary, double-click **setup.exe**.

- 7 Follow the instructions on the computer screen to install the software.
- 8 When the installation is completed, enable the security software again.

## Page does not print

These are possible solutions. Try one or more of the following:

### CHECK MESSAGES

If an error message appears, then resolve the error before trying to print again.

### CHECK POWER

If the  light is not on, then make sure that the power cord is properly connected to the printer and plugged into a known working electrical outlet that other electrical devices have been using.

### REMOVE AND THEN RELOAD PAPER

### CHECK INK

Check the ink levels, and then install new print cartridges if necessary.

### CHECK CARTRIDGES

- 1 Remove the print cartridges.
- 2 Make sure the sticker and tape have been removed.

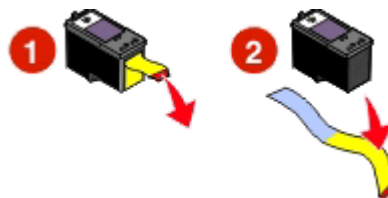

- 3 Reinsert the cartridges.

### CHECK PRINTER DEFAULT AND PAUSE SETTINGS

#### Using Windows

- 1 Do one of the following:

##### In Windows Vista

- a Click .
- b Click **Control Panel**.
- c Under Hardware and Sound, click **Printer**.

## In Windows XP

- a Click **Start**.
- b Click **Printers and Faxes**.

## In Windows 2000

- a Click **Start**.
  - b Click **Settings → Printers**.
- 2 Double-click the printer.
  - 3 Click **Printer**.
    - Make sure no check mark appears next to Pause Printing.
    - If a check mark does not appear next to Set As Default Printer, then you must select the printer for each file that you want to print.

## Using Macintosh

### For Mac OS X version 10.5 or later

- 1 From the Finder desktop, click  → **System Preferences → Print & Fax**.
- 2 From the Default Printer pop-up menu, check if the printer is the default printer.

If the printer is not the default printer, then you must select the printer for each file that you want to print.

If you want to set the printer as the default printer, then select the printer from the Default Printer pop-up menu.
- 3 Click **Open Print Queue**.

The print queue dialog appears.

Make sure that the print job is not on hold. If the print job is on hold:

  - If you want to resume a particular print job, choose the document name, and then click **Resume**.
  - If you want to resume all print jobs in the queue, then click **Resume Printer**.

### For Mac OS X version 10.4 and earlier

- 1 From the Finder desktop, click **Go → Utilities → Print Center** or **Printer Setup Utility**.

The Printer List dialog appears.
- 2 Double-click the printer.

The print queue dialog appears.

  - Make sure that the print job is not on hold.



If the print job is on hold:

    - If you want to resume a particular print job, choose the document name, and then click **Resume**.
    - If you want to resume all print jobs in the queue, then click **Start Jobs**.
  - If the printer is not in bold, then it is not the default printer. You must select the printer for each file that you want to print.

If you want to set the printer as the default printer:

    - a Go back to the Printer List dialog, and then select the printer.
    - b Click **Make Default**.

## DISCONNECT AND RECONNECT POWER SUPPLY

- 1 Press  to turn off the printer.
- 2 Disconnect the power cord from the wall outlet.
- 3 Remove the power supply from the printer.
- 4 Reconnect the power supply to the printer.
- 5 Plug the power cord into the wall outlet.
- 6 Press  to turn on the printer.

## REMOVE AND REINSTALL THE SOFTWARE

If you encountered problems while installing, or if your printer does not appear in the printers folder or as a printer option when sending a print job, then try uninstalling and reinstalling the software.

## Removing and reinstalling the software

If the printer is not functioning properly, or if a communications error message appears when you try to use the printer, you may need to remove and reinstall the printer software.

### Using Windows

- 1 Do one of the following:
  - In Windows Vista, click .
  - In Windows XP, click **Start**.
- 2 Click **Programs** or **All Programs**, and then select the printer program folder from the list.
- 3 Select **Uninstall**.
- 4 Follow the instructions on the computer screen to remove the printer software.
- 5 Restart the computer before reinstalling the printer software.
- 6 Click **Cancel** on all New Hardware Found screens.
- 7 Insert the installation CD, and then follow the instructions on the computer screen to reinstall the software.  
If the install screen does not appear automatically after you restart your computer, do one of the following:

#### In Windows Vista:

- a Click .
- b Locate the Start Search box.
- c Type **D:\setup.exe**, where **D** is the letter of your CD or DVD drive.

#### In Windows XP:

- a Click **Start → Run**.
- b Type **D:\setup.exe**, where **D** is the letter of your CD or DVD drive.

## Using Macintosh

- 1 Close all open software applications.
- 2 From the Finder desktop, double-click the printer folder.
- 3 Double-click the **Uninstaller** icon.
- 4 Follow the instructions on the computer screen to remove the printer software.
- 5 Restart the computer before reinstalling the printer software.
- 6 Insert the installation CD, and then follow the instructions on the computer screen to reinstall the software.

If the software still does not install correctly, visit our Web site at [www.lexmark.com](http://www.lexmark.com) to check for the latest software.

- 1 In all countries or regions except the United States, select your country or region.
- 2 Click the links for drivers or downloads.
- 3 Select your printer family.
- 4 Select your printer model.
- 5 Select your operating system.
- 6 Select the file that you want to download, and then follow the directions on the computer screen.

## Enabling the USB port in Windows

To confirm that the USB port is enabled on the computer:

- 1 Do one of the following:

### In Windows Vista

- a Click  → **Control Panel**.
- b Click **System and Maintenance** → **System**.
- c Click **Device Manager**.

### In Windows XP

- a Click **Start**.
- b Click **Control Panel** → **Performance and Maintenance** → **System**.
- c From the Hardware tab, click **Device Manager**.

### In Windows 2000

- a Click **Start**.
- b Click **Settings** → **Control Panel** → **System**.
- c From the Hardware tab, click **Device Manager**.

- 2 Click the plus sign (+) beside **Universal Serial Bus Controller**.

If USB Host Controller and USB Root Hub are listed, then the USB port is enabled.



For more information, see the computer documentation.

## Solving printer power problems

The printer and the computer cannot exchange data.

These are possible solutions. Try one or more of the following:

### **MAKE SURE THE PRINTER POWER SUPPLY IS ATTACHED CORRECTLY**

- 1 Press  to turn the printer off.
- 2 Disconnect the power cord from the wall outlet.
- 3 Remove the power supply from the printer.
- 4 Reconnect the power supply to the printer.
- 5 Plug the power cord into the wall outlet.
- 6 Press  to turn the printer on.

### **MAKE SURE THE PRINTER IS NOT IN SLEEP MODE**

If the power light is blinking on and off slowly, then the printer is in sleep mode. Press  to turn the printer on.



# Notices

## Product information

Product name:

Lexmark 2600 Series

Machine type:

4433, 4445

Model(s):

Various, xxx, where "x" is any alphanumeric character

## Edition notice

January 2009

**The following paragraph does not apply to any country where such provisions are inconsistent with local law:** LEXMARK INTERNATIONAL, INC., PROVIDES THIS PUBLICATION "AS IS" WITHOUT WARRANTY OF ANY KIND, EITHER EXPRESS OR IMPLIED, INCLUDING, BUT NOT LIMITED TO, THE IMPLIED WARRANTIES OF MERCHANTABILITY OR FITNESS FOR A PARTICULAR PURPOSE. Some states do not allow disclaimer of express or implied warranties in certain transactions; therefore, this statement may not apply to you.

This publication could include technical inaccuracies or typographical errors. Changes are periodically made to the information herein; these changes will be incorporated in later editions. Improvements or changes in the products or the programs described may be made at any time.

References in this publication to products, programs, or services do not imply that the manufacturer intends to make these available in all countries in which it operates. Any reference to a product, program, or service is not intended to state or imply that only that product, program, or service may be used. Any functionally equivalent product, program, or service that does not infringe any existing intellectual property right may be used instead. Evaluation and verification of operation in conjunction with other products, programs, or services, except those expressly designated by the manufacturer, are the user's responsibility.

For Lexmark technical support, visit [support.lexmark.com](http://support.lexmark.com).

For information on supplies and downloads, visit [www.lexmark.com](http://www.lexmark.com).

If you don't have access to the Internet, you can contact Lexmark by mail:

Lexmark International, Inc.  
Bldg 004-2/CSC  
740 New Circle Road NW  
Lexington, KY 40550  
USA

© 2009 Lexmark International, Inc.

All rights reserved.

# UNITED STATES GOVERNMENT RIGHTS

This software and any accompanying documentation provided under this agreement are commercial computer software and documentation developed exclusively at private expense.

## Trademarks

Lexmark and Lexmark with diamond design are trademarks of Lexmark International, Inc., registered in the United States and/or other countries.

Evercolor and PerfectFinish are trademarks of Lexmark International, Inc.

All other trademarks are the property of their respective owners.

## Licensing notices

The following documents can be viewed from the installation software CD.

Directory	File
\drivers\xps	ZOpen.3.08.pdf
\Pubs	FW_License.10.08.pdf
\Install\Licenses	Expat.txt Inst_lib.txt Instgui.txt/Instgui.zip

## Federal Communications Commission (FCC) compliance information statement

This product has been tested and found to comply with the limits for a Class B digital device, pursuant to Part 15 of the FCC Rules. Operation is subject to the following two conditions: (1) this device may not cause harmful interference, and (2) this device must accept any interference received, including interference that may cause undesired operation.

The FCC Class B limits are designed to provide reasonable protection against harmful interference when the equipment is operated in a residential installation. This equipment generates, uses, and can radiate radio frequency energy and, if not installed and used in accordance with the instructions, may cause harmful interference to radio communications. However, there is no guarantee that interference will not occur in a particular installation. If this equipment does cause harmful interference to radio or television reception, which can be determined by turning the equipment off and on, the user is encouraged to try to correct the interference by one or more of the following measures:

- Reorient or relocate the receiving antenna.
- Increase the separation between the equipment and receiver.
- Connect the equipment into an outlet on a circuit different from that to which the receiver is connected.
- Consult your point of purchase or service representative for additional suggestions.

The manufacturer is not responsible for radio or television interference caused by using other than recommended cables or by unauthorized changes or modifications to this equipment. Unauthorized changes or modifications could void the user's authority to operate this equipment.

**Note:** To assure compliance with FCC regulations on electromagnetic interference for a Class B computing device, use a properly shielded and grounded cable such as Lexmark part number 1021294 for USB attach. Use of a substitute cable not properly shielded and grounded may result in a violation of FCC regulations.

Any questions regarding this compliance information statement should be directed to:

Director of Lexmark Technology & Services  
Lexmark International, Inc.  
740 West New Circle Road  
Lexington, KY 40550  
(859) 232-3000

## Hinweis zum GS-Zeichen

Modell	Verschiedene, xxx, wobei "x" einem alphanumerischen Zeichen entspricht
Gerätetyp	4433, 4445
Postanschrift	Lexmark Deutschland GmbH Postfach 1560 63115 Dietzenbach
Adresse	Lexmark Deutschland GmbH Max-Planck-Straße 12 63128 Dietzenbach
Telefon	0180 - 564 56 44 (Produktinformationen)
Telefon	01805- 51 25 11 (Technischer Kundendienst)
E-mail	internet@lexmark.de

## Noise emission levels

The following measurements were made in accordance with ISO 7779 and reported in conformance with ISO 9296.

**Note:** Some modes may not apply to your product.

1-meter average sound pressure, dBA	
Printing	50
Scanning	34
Copying	44
Ready	inaudible

Values are subject to change. See [www.lexmark.com](http://www.lexmark.com) for current values.

## Temperature information

Ambient temperature	15–32° C (60–90° F)
Shipping temperature	-40–60° C (-40–140° F)
Storage temperature	1–60° C (34–140° F)

## Waste from Electrical and Electronic Equipment (WEEE) directive



The WEEE logo signifies specific recycling programs and procedures for electronic products in countries of the European Union. We encourage the recycling of our products. If you have further questions about recycling options, visit the Lexmark Web site at [www.lexmark.com](http://www.lexmark.com) for your local sales office phone number.

## Product disposal

Do not dispose of the printer or supplies in the same manner as normal household waste. Consult your local authorities for disposal and recycling options.

## ENERGY STAR

Any Lexmark product bearing the ENERGY STAR emblem on the product or on a start-up screen is certified to comply with Environmental Protection Agency (EPA) ENERGY STAR requirements as configured when shipped by Lexmark.



## Power consumption

### Product power consumption

The following table documents the power consumption characteristics of the product.

**Note:** Some modes may not apply to your product.

Mode	Description	Power consumption (Watts)
Printing	The product is generating hard-copy output from electronic inputs.	13.04 (ENERGY STAR-compliant X2600); 14.97 (non-ENERGY STAR-compliant X2600)
Copying	The product is generating hard-copy output from hard-copy original documents.	11.84 (ENERGY STAR-compliant X2600); 13.79 (non-ENERGY STAR-compliant X2600)
Scanning	The product is scanning hard-copy documents.	6.58 (ENERGY STAR-compliant X2600); 7.24 (non-ENERGY STAR-compliant X2600)
Ready	The product is waiting for a print job.	3.87 (ENERGY STAR-compliant X2600); 5.80 (non-ENERGY STAR-compliant X2600)
Power Saver	The product is in energy-saving mode.	2.21 (ENERGY STAR-compliant X2600); not applicable (non-ENERGY STAR-compliant X2600)
Off	The product is plugged into a wall outlet, but the power switch is turned off.	0.21 (ENERGY STAR-compliant X2600); 5.62 (non-ENERGY STAR-compliant X2600)

The power consumption levels listed in the previous table represent time-averaged measurements. Instantaneous power draws may be substantially higher than the average.

Values are subject to change. See [www.lexmark.com](http://www.lexmark.com) for current values.

## Power Saver

This product is designed with an energy-saving mode called Power Saver. The Power Saver Mode is equivalent to the EPA Sleep Mode. The Power Saver Mode saves energy by lowering power consumption during extended periods of inactivity. The Power Saver Mode is automatically engaged after this product is not used for a specified period of time, called the Power Saver Timeout.

Factory default Power Saver Timeout for this product (in minutes):	n/a
--	-----

## Off mode

If this product has an off mode which still consumes a small amount of power, then to completely stop product power consumption, disconnect the power supply cord from the wall outlet.

## Total energy usage

It is sometimes helpful to calculate the total product energy usage. Since power consumption claims are provided in power units of Watts, the power consumption should be multiplied by the time the product spends in each mode in order to calculate energy usage. The total product energy usage is the sum of each mode's energy usage.

# LEXMARK SOFTWARE LIMITED WARRANTY AND LICENSE AGREEMENTS

PLEASE READ CAREFULLY BEFORE USING THIS PRODUCT: BY USING THIS PRODUCT, YOU AGREE TO BE BOUND BY ALL THE TERMS AND CONDITIONS OF THIS SOFTWARE LIMITED WARRANTY AND LICENSE AGREEMENTS. IF YOU DO NOT AGREE WITH THE TERMS OF THIS SOFTWARE LIMITED WARRANTY AND LICENSE AGREEMENTS, PROMPTLY RETURN THE PRODUCT UNUSED AND REQUEST A REFUND OF THE AMOUNT YOU PAID. IF YOU ARE INSTALLING THIS PRODUCT FOR USE BY OTHER PARTIES, YOU AGREE TO INFORM THE USERS THAT USE OF THE PRODUCT INDICATES ACCEPTANCE OF THESE TERMS.

## PRINTER LICENSE AGREEMENT

I agree that this patented printer is licensed for, and designed to work with only genuine Lexmark ink cartridges for the life of the patented printer. I agree to: (1) use only genuine Lexmark ink cartridges with this printer (except I may use replacement cartridges made by Lexmark but sold without single use terms as described in the below cartridge license agreement), and (2) pass this printer license/agreement to any subsequent user of this printer.

## CARTRIDGE LICENSE AGREEMENT\*

I agree that the patented print cartridge(s) shipped with this printing device are sold subject to the following license/agreement: The patented print cartridge(s) contained inside is/are licensed for a single use only and is/are designed to stop working after delivering a fixed amount of ink. A variable amount of ink will remain in the cartridge when replacement is required. After this single use, the license to use the print cartridge terminates, and the used cartridge must be returned only to Lexmark for remanufacturing, refilling or recycling. If I buy another cartridge in the future that is sold subject to the above terms, I accept such terms as to that cartridge. If you do not accept the terms of this single use license/agreement; return this product in its original packaging to your point of purchase. A replacement cartridge sold without these terms is available at [www.lexmark.com](http://www.lexmark.com).

## LEXMARK SOFTWARE LICENSE AGREEMENT

This Software License Agreement ("License Agreement") is a legal agreement between you (either an individual or a single entity) and Lexmark International, Inc. ("Lexmark") that, to the extent your Lexmark product or Software Program is not otherwise subject to a written software license agreement between you and Lexmark or its suppliers, governs your use of any Software Program installed on or provided by Lexmark for use in connection with your Lexmark product. The term "Software Program" includes machine-readable instructions, audio/visual content (such as images and recordings), and associated media, printed materials and electronic documentation, whether incorporated into, distributed with or for use with your Lexmark product.

- 1 STATEMENT OF SOFTWARE LIMITED WARRANTY.** Lexmark warrants that the media (e.g., diskette or compact disk) on which the Software Program (if any) is furnished is free from defects in materials and workmanship under normal use during the warranty period. The warranty period is ninety (90) days and commences on the date the Software Program is delivered to the original end-user. This limited warranty applies only to Software Program media purchased new from Lexmark or an Authorized Lexmark Reseller or Distributor. Lexmark will replace the Software Program should it be determined that the media does not conform to this limited warranty.
- 2 DISCLAIMER AND LIMITATION OF WARRANTIES.** EXCEPT AS PROVIDED IN THIS SOFTWARE LICENSE AGREEMENT AND TO THE MAXIMUM EXTENT PERMITTED BY APPLICABLE LAW, LEXMARK AND ITS SUPPLIERS PROVIDE THE SOFTWARE PROGRAM "AS IS" AND HEREBY DISCLAIM ALL OTHER WARRANTIES AND CONDITIONS, EITHER EXPRESS OR IMPLIED, INCLUDING, BUT NOT LIMITED TO, TITLE, NON-INFRINGEMENT, MERCHANTABILITY AND FITNESS FOR A PARTICULAR PURPOSE, AND ABSENCE OF VIRUSES, ALL WITH REGARD TO THE SOFTWARE PROGRAM. TO THE EXTENT LEXMARK CANNOT BY LAW DISCLAIM ANY COMPONENT OF THE IMPLIED WARRANTIES OF MERCHANTABILITY OR FITNESS FOR A PARTICULAR PURPOSE, LEXMARK LIMITS THE DURATION OF SUCH WARRANTIES TO THE 90-DAY TERM OF THE EXPRESS SOFTWARE LIMITED WARRANTY. This Agreement is to be read in conjunction with certain statutory provisions, as that may be in force from time to time, that imply warranties or conditions or impose obligations on Lexmark that cannot be excluded or modified. If any such provisions apply, then to the extent Lexmark is able, Lexmark hereby limits its liability for breach of those provisions to one of the following: providing you a replacement copy of the Software Program or reimbursement of the price paid for the Software Program.

The Software Program may include internet links to other software applications and/or internet web pages hosted and operated by third parties unaffiliated with Lexmark. You acknowledge and agree that Lexmark is not responsible in any way for the hosting, performance, operation, maintenance, or content of, such software applications and/or internet web pages.

**3 LIMITATION OF REMEDY.** TO THE MAXIMUM EXTENT PERMITTED BY APPLICABLE LAW, ANY AND ALL LIABILITY OF LEXMARK UNDER THIS SOFTWARE LICENSE AGREEMENT IS EXPRESSLY LIMITED TO THE GREATER OF THE PRICE PAID FOR THE SOFTWARE PROGRAM AND FIVE U.S. DOLLARS (OR THE EQUIVALENT IN LOCAL CURRENCY). YOUR SOLE REMEDY AGAINST LEXMARK IN ANY DISPUTE UNDER THIS SOFTWARE LICENSE AGREEMENT SHALL BE TO SEEK TO RECOVER ONE OF THESE AMOUNTS, UPON PAYMENT OF WHICH LEXMARK SHALL BE RELEASED AND DISCHARGED OF ALL FURTHER OBLIGATIONS AND LIABILITY TO YOU.

IN NO EVENT WILL LEXMARK, ITS SUPPLIERS, SUBSIDIARIES, OR RESELLERS BE LIABLE FOR ANY SPECIAL, INCIDENTAL, INDIRECT, EXEMPLARY, PUNITIVE, OR CONSEQUENTIAL DAMAGES (INCLUDING BUT NOT LIMITED TO LOST PROFITS OR REVENUES, LOST SAVINGS, INTERRUPTION OF USE OR ANY LOSS OF, INACCURACY IN, OR DAMAGE TO, DATA OR RECORDS, FOR CLAIMS OF THIRD PARTIES, OR DAMAGE TO REAL OR TANGIBLE PROPERTY, FOR LOSS OF PRIVACY ARISING OUT OR IN ANY WAY RELATED TO THE USE OF OR INABILITY TO USE THE SOFTWARE PROGRAM, OR OTHERWISE IN CONNECTION WITH ANY PROVISION OF THIS SOFTWARE LICENCE AGREEMENT), REGARDLESS OF THE NATURE OF THE CLAIM, INCLUDING BUT NOT LIMITED TO BREACH OF WARRANTY OR CONTRACT, TORT (INCLUDING NEGLIGENCE OR STRICT LIABILITY), AND EVEN IF LEXMARK, OR ITS SUPPLIERS, AFFILIATES, OR REMARKETERS HAVE BEEN ADVISED OF THE POSSIBILITY OF SUCH DAMAGES, OR FOR ANY CLAIM BY YOU BASED ON A THIRD-PARTY CLAIM, EXCEPT TO THE EXTENT THIS EXCLUSION OF DAMAGES IS DETERMINED LEGALLY INVALID. THE FOREGOING LIMITATIONS APPLY EVEN IF THE ABOVE-STATED REMEDIES FAIL OF THEIR ESSENTIAL PURPOSE.

**4 U.S.A. STATE LAWS.** This Software Limited Warranty gives you specific legal rights. You may also have other rights that vary from state to state. Some states do not allow limitations on how long an implied warranty lasts or the exclusion of limitation of incidental or consequential damages, so the above limitations may not apply to you.

**5 LICENSE GRANT.** Lexmark grants you the following rights provided you comply with all terms and conditions of this License Agreement:

- a Use.** You may Use one (1) copy of the Software Program. The term "Use" means storing, loading, installing, executing, or displaying the Software Program. If Lexmark has licensed the Software Program to you for concurrent use, you must limit the number of authorized users to the number specified in your agreement with Lexmark. You may not separate the components of the Software Program for use on more than one computer. You agree that you will not Use the Software Program, in whole or in part, in any manner that has the effect of overriding, modifying, eliminating, obscuring, altering or de-emphasizing the visual appearance of any trademark, trade name, trade dress or intellectual property notice that appears on any computer display screens normally generated by, or as a result of, the Software Program.
- b Copying.** You may make one (1) copy of the Software Program solely for purposes of backup, archiving, or installation, provided the copy contains all of the original Software Program's proprietary notices. You may not copy the Software Program to any public or distributed network.
- c Reservation of Rights.** The Software Program, including all fonts, is copyrighted and owned by Lexmark International, Inc. and/or its suppliers. Lexmark reserves all rights not expressly granted to you in this License Agreement.
- d Freeware.** Notwithstanding the terms and conditions of this License Agreement, all or any portion of the Software Program that constitutes software provided under public license by third parties ("Freeware") is licensed to you subject to the terms and conditions of the software license agreement accompanying such Freeware, whether in the form of a discrete agreement, shrink-wrap license, or electronic license terms at the time of download. Use of the Freeware by you shall be governed entirely by the terms and conditions of such license.

- 6 TRANSFER.** You may transfer the Software Program to another end-user. Any transfer must include all software components, media, printed materials, and this License Agreement and you may not retain copies of the Software Program or components thereof. The transfer may not be an indirect transfer, such as a consignment. Prior to the transfer, the end-user receiving the transferred Software Program must agree to all these License Agreement terms. Upon transfer of the Software Program, your license is automatically terminated. You may not rent, sublicense, or assign the Software Program except to the extent provided in this License Agreement, and any attempt to do so shall be void.
- 7 UPGRADES.** To Use a Software Program identified as an upgrade, you must first be licensed to the original Software Program identified by Lexmark as eligible for the upgrade. After upgrading, you may no longer use the original Software Program that formed the basis for your upgrade eligibility.
- 8 LIMITATION ON REVERSE ENGINEERING.** You may not alter, decrypt, reverse engineer, reverse assemble, reverse compile or otherwise translate the Software Program, except as and to the extent expressly permitted to do so by applicable law for the purposes of inter-operability, error correction, and security testing. If you have such statutory rights, you will notify Lexmark in writing of any intended reverse engineering, reverse assembly, or reverse compilation. You may not decrypt the Software Program unless necessary for the legitimate Use of the Software Program.
- 9 ADDITIONAL SOFTWARE.** This License Agreement applies to updates or supplements to the original Software Program provided by Lexmark unless Lexmark provides other terms along with the update or supplement.
- 10 TERM.** This License Agreement is effective unless terminated or rejected. You may reject or terminate this license at any time by destroying all copies of the Software Program, together with all modifications, documentation, and merged portions in any form, or as otherwise described herein. Lexmark may terminate your license upon notice if you fail to comply with any of the terms of this License Agreement. Upon such termination, you agree to destroy all copies of the Software Program together with all modifications, documentation, and merged portions in any form.
- 11 TAXES.** You agree that you are responsible for payment of any taxes including, without limitation, any goods and services and personal property taxes, resulting from this Agreement or your Use of the Software Program.
- 12 LIMITATION ON ACTIONS.** No action, regardless of form, arising out of this Agreement may be brought by either party more than two years after the cause of action has arisen, except as provided under applicable law.
- 13 APPLICABLE LAW.** This Agreement is governed by the laws of the Commonwealth of Kentucky, United States of America. No choice of law rules in any jurisdiction shall apply. The UN Convention on Contracts for the International Sale of Goods shall not apply.
- 14 UNITED STATES GOVERNMENT RESTRICTED RIGHTS.** The Software Program has been developed entirely at private expense. Rights of the United States Government to use the Software Program is as set forth in this Agreement and as restricted in DFARS 252.227-7014 and in similar FAR provisions (or any equivalent agency regulation or contract clause).
- 15 CONSENT TO USE OF DATA.** You agree that Lexmark, its affiliates, and agents may collect and use information you provide in relation to support services performed with respect to the Software Program and requested by you. Lexmark agrees not to use this information in a form that personally identifies you except to the extent necessary to provide such services.
- 16 EXPORT RESTRICTIONS.** You may not (a) acquire, ship, transfer, or reexport, directly or indirectly, the Software Program or any direct product therefrom, in violation of any applicable export laws or (b) permit the Software Program to be used for any purpose prohibited by such export laws, including, without limitation, nuclear, chemical, or biological weapons proliferation.
- 17 AGREEMENT TO CONTRACT ELECTRONICALLY.** You and Lexmark agree to form this License Agreement electronically. This means that when you click the "Agree" or "Yes" button on this page or use this product, you acknowledge your agreement to these License Agreement terms and conditions and that you are doing so with the intent to "sign" a contract with Lexmark.



**18 CAPACITY AND AUTHORITY TO CONTRACT.** You represent that you are of the legal age of majority in the place you sign this License Agreement and, if applicable, you are duly authorized by your employer or principal to enter into this contract.

**19 ENTIRE AGREEMENT.** This License Agreement (including any addendum or amendment to this License Agreement that is included with the Software Program) is the entire agreement between you and Lexmark relating to the Software Program. Except as otherwise provided for herein, these terms and conditions supersede all prior or contemporaneous oral or written communications, proposals, and representations with respect to the Software Program or any other subject matter covered by this License Agreement (except to the extent such extraneous terms do not conflict with the terms of this License Agreement, any other written agreement signed by you and Lexmark relating to your Use of the Software Program). To the extent any Lexmark policies or programs for support services conflict with the terms of this License Agreement, the terms of this License Agreement shall control.

\* Products within the XX90 Series (including but not limited to models Z2390, Z2490, X2690, X3690, and X4690) are not subject to the Cartridge License Agreement. This Cartridge License Agreement does not apply to cartridges included within the printer boxes of XX75 Series products (including but not limited to models X4975 and X7675). It applies to replacement cartridges that are sold subject to these terms and conditions, however. Replacement cartridges sold without these terms are available through [www.lexmark.com](http://www.lexmark.com).

## MICROSOFT CORPORATION NOTICES

- 1 This product may incorporate intellectual property owned by Microsoft Corporation. The terms and conditions upon which Microsoft is licensing such intellectual property may be found at <http://go.microsoft.com/fwlink/?LinkId=52369>.
- 2 This product is based on Microsoft Print Schema technology. You may find the terms and conditions upon which Microsoft is licensing such intellectual property at <http://go.microsoft.com/fwlink/?LinkId=83288>.

## ADOBE SYSTEMS INCORPORATED NOTICE

Contains Flash®, Flash® Lite™ and/or Reader® technology by Adobe Systems Incorporated

This Product contains Adobe® Flash® player software under license from Adobe Systems Incorporated, Copyright © 1995-2007 Adobe Macromedia Software LLC. All rights reserved. Adobe, Reader and Flash are trademarks of Adobe Systems Incorporated.

## European Community (EC) directives conformity

This product is in conformity with the protection requirements of EC Council directives 2004/108/EC and 2006/95/EC on the approximation and harmonization of the laws of the Member States relating to electromagnetic compatibility and safety of electrical equipment designed for use within certain voltage limits.

A declaration of conformity with the requirements of the directives has been signed by the Director of Manufacturing and Technical Support, Lexmark International, Inc., S.A., Boigny, France.

This product satisfies the Class B limits of EN 55022 and safety requirements of EN 60950.

## Industry Canada compliance statement

This Class B digital apparatus meets all requirements of the Canadian Interference-Causing Equipment Standard ICES-003.

## Avis de conformité aux normes de l'industrie du Canada

Cet appareil numérique de classe B est conforme aux exigences de la norme canadienne relative aux équipements pouvant causer des interférences NMB-003.

## Regulatory notices for telecommunication terminal equipment

This section contains regulatory information pertaining to products that contain telecommunication terminal equipment such as facsimile.

### Notice to users of the US telephone network: FCC requirements

This equipment complies with Part 68 of the FCC rules and the requirements adopted by the Administrative Council for Terminal Attachments (ACTA). On the back of this equipment is a label that contains, among other information, a product identifier in the format US:AAAEQ##TXXXX. If requested, this number must be provided to your telephone company.

This equipment uses the RJ-11C Universal Service Order Code (USOC) jack.

A plug and jack used to connect this equipment to the premises' wiring and telephone network must comply with the applicable FCC Part 68 rules and requirements adopted by the ACTA. A compliant telephone cord and modular plug is provided with this product. It is designed to be connected to a compatible modular jack that is also compliant. See your setup documentation for more information.

The Ringer Equivalence Number (REN) is used to determine the number of devices that may be connected to a telephone line. Excessive RENs on a telephone line may result in the devices not ringing in response to an incoming call. In most but not all areas, the sum of RENs should not exceed five (5.0). To be certain of the number of devices that may be connected to a line, as determined by the total RENs, contact your local telephone company. For products approved after July 23, 2001, the REN for this product is part of the product identifier that has the format US:AAAEQ##TXXXX. The digits represented by ## are the REN without a decimal point (for example, 03 is a REN of 0.3). For earlier products, the REN is shown separately on the label.

If this equipment causes harm to the telephone network, the telephone company will notify you in advance that temporary discontinuance of service may be required. If advance notice is not practical, the telephone company will notify the customer as soon as possible. You will also be advised of your right to file a complaint with the FCC.

The telephone company may make changes in its facilities, equipment, operations or procedures that could affect the operation of this equipment. If this happens, the telephone company will provide advance notice in order for you to make necessary modifications to maintain uninterrupted service.

If you experience trouble with this equipment, for repair or warranty information, contact Lexmark International, Inc. at [www.lexmark.com](http://www.lexmark.com) or your Lexmark representative. If the equipment is causing harm to the telephone network, the telephone company may request that you disconnect the equipment until the problem is resolved.

This equipment contains no user serviceable parts. For repair and warranty information, contact Lexmark International, Inc. See the previous paragraph for contact information.

Connection to party line service is subject to state tariffs. Contact the state public utility commission, public service commission, or corporation commission for information.

If your home has specially wired alarm equipment connected to the telephone line, ensure the installation of this equipment does not disable your alarm equipment. If you have questions about what will disable alarm equipment, consult your telephone company or a qualified installer.

Telephone companies report that electrical surges, typically lightning transients, are very destructive to customer terminal equipment connected to AC power sources. This has been identified as a major nationwide problem. It is recommended that the customer install an appropriate AC surge arrester in the AC outlet to which this device is connected. An appropriate AC surge arrester is defined as one that is suitably rated, and certified by UL (Underwriter's Laboratories), another NRTL (Nationally Recognized Testing Laboratory), or a recognized safety certification body in the country/region of use. This is to avoid damage to the equipment caused by local lightning strikes and other electrical surges.

The Telephone Consumer Protection Act of 1991 makes it unlawful for any person to use a computer or other electronic device, including fax machines, to send any message unless said message clearly contains in a margin at the top or bottom of each transmitted page or on the first page of the transmission, the date and time it is sent and an identification of the business or other entity, or other individual sending the message, and the telephone number of the sending machine or such business, other entity, or individual. (The telephone number provided may not be a 900 number or any other number for which charges exceed local or long-distance transmission charges.)

See your user documentation in order to program this information into your fax machine.

## **South Africa telecommunications notice**

This modem must be used in conjunction with an approved surge protection device when connected to the PSTN.

## **Notice to users of the Canadian telephone network**

This product meets the applicable Industry Canada technical specifications. The Ringer Equivalence Number (REN) is an indication of the maximum number of terminals allowed to be connected to a telephone interface. The terminus of an interface may consist of any combination of devices, subject only to the requirement that the sum of the RENs of all the devices does not exceed five. The modem REN is located on the rear of the equipment on the product labeling.

Telephone companies report that electrical surges, typically lightning transients, are very destructive to customer terminal equipment connected to AC power sources. This has been identified as a major nationwide problem. It is recommended that the customer install an appropriate AC surge arrester in the AC outlet to which this device is connected. An appropriate AC surge arrester is defined as one that is suitably rated, and certified by UL (Underwriter's Laboratories), another NRTL (Nationally Recognized Testing Laboratory), or a recognized safety certification body in the country/region of use. This is to avoid damage to the equipment caused by local lightning strikes and other electrical surges.

This equipment uses CA11A telephone jacks.

## **Avis réservé aux utilisateurs du réseau téléphonique du Canada**

Ce produit est conforme aux spécifications techniques d'Industrie Canada. Le numéro REN (ringer equivalence number : numéro d'équivalence de sonnerie) fournit une indication du nombre maximum de terminaux pouvant être connectés à l'interface téléphonique. En bout de ligne, le nombre d'appareils qui peuvent être connectés n'est pas directement limité, mais la somme des REN de ces appareils ne doit pas dépasser cinq. Le numéro REN du modem est indiqué sur l'étiquette produit située à l'arrière de l'équipement.

Les compagnies de téléphone constatent que les surtensions électriques, en particulier celles dues à la foudre, entraînent d'importants dégâts sur les terminaux privés connectés à des sources d'alimentation CA. Il s'agit-là d'un problème majeur d'échelle nationale. En conséquence, il vous est recommandé de brancher un parasurtenseur dans la prise de courant à laquelle l'équipement est connecté. Utilisez un parasurtenseur répondant à des caractéristiques nominales satisfaisantes et certifié par le laboratoire d'assureurs UL (Underwriter's Laboratories), un autre laboratoire agréé de type NRTL (Nationally Recognized Testing Laboratory) ou un organisme de certification agréé dans votre région ou pays. Ceci prévient tout endommagement de l'équipement causé par les orages et autres surtensions électriques.

Cet équipement utilise des prises de téléphone CA11A.

## **Notice to users of the New Zealand telephone network**

The following are special conditions for the Facsimile User Instructions. The grant of a telepermit for any item of terminal equipment indicates only that Telecom has accepted that the item complies with minimum conditions for connection to its network. It indicates no endorsement of the product by Telecom, nor does it provide any sort of warranty. Above all, it provides no assurance that any item will work correctly in all respects with another item of telepermitted equipment of a different make or model, nor does it imply that any product is compatible with all of Telecom's network services.

This equipment shall not be set up to make automatic calls to the Telecom's 111 Emergency Service.

This equipment may not provide for the effective hand-over of a call to another device connected to the same line.

This equipment should not be used under any circumstances that may constitute a nuisance to other Telecom customers.

Some parameters required for compliance with Telecom's telepermit requirements are dependent on the equipment associated with this device. The associated equipment shall be set to operate within the following limits for compliance to Telecom's specifications:

- There shall be no more than 10 call attempts to the same number within any 30 minute period for any single manual call initiation, and
- The equipment shall go on-hook for a period of not less than 30 seconds between the end of one attempt and the beginning of the next call attempt.
- The equipment shall be set to ensure that automatic calls to different numbers are spaced such that there is not less than 5 seconds between the end of one call attempt and the beginning of another.

## **Using this product in Switzerland**

This product requires a Swiss billing tone filter (Lexmark part number 14B5109 or 80D1877) to be installed on any line which receives metering pulses in Switzerland. The Lexmark filter must be used, as metering pulses are present on all analog telephone lines in Switzerland.

## **Utilisation de ce produit en Suisse**

Cet appareil nécessite l'utilisation d'un filtre de tonalité de facturation suisse (n° de référence Lexmark : 14B5109 ou 80D1877) devant être installé sur toute ligne recevant des impulsions de comptage en Suisse. Ce filtre doit être utilisé pour toute installation car ces impulsions existent sur toutes les lignes téléphoniques suisses.

## Verwendung dieses Produkts in der Schweiz

Für dieses Produkt muss ein schweizerischer Billing Tone Filter zur Zählzeichenübertragung (Lexmark Teilenummer 14B5109 oder 80D1877) für jede Leitung installiert werden, über die in der Schweiz Zeitsteuertakte übertragen werden. Die Verwendung des Lexmark Filters ist obligatorisch, da in allen analogen Telefonleitungen in der Schweiz Zeitsteuertakte vorhanden sind.

## Uso del prodotto in Svizzera

Questo prodotto richiede un filtro toni Billing svizzero, (codice Lexmark 14B5109 o 80D1877) da installare su tutte le linee che ricevono impulsi remoti in Svizzera. È necessario utilizzare il filtro Lexmark poiché gli impulsi remoti sono presenti su tutte le linee analogiche in Svizzera.

## Notice to Users in the European Union

Products bearing the CE mark are in conformity with the protection requirements of EC Council directives 2004/108/EC, 2006/95/EC, and 1999/5/EC on the approximation and harmonization of the laws of the Member States relating to electromagnetic compatibility, safety of electrical equipment designed for use within certain voltage limits and on radio equipment and telecommunications terminal equipment.

Compliance is indicated by the CE marking.



A declaration of conformity with the requirements of the directives is available from the Director of Manufacturing and Technical Support, Lexmark International, S. A., Boigny, France.

Refer to the table at the end of the Notices section for further compliance information.

## Regulatory notices for wireless products

This section contains the following regulatory information pertaining to wireless products that contain transmitters, for example, but not limited to, wireless network cards or proximity card readers.

## Exposure to radio frequency radiation

The radiated output power of this device is far below the radio frequency exposure limits of the FCC and other regulatory agencies. A minimum separation of 20 cm (8 inches) must be maintained between the antenna and any persons for this device to satisfy the RF exposure requirements of the FCC and other regulatory agencies.

## Notice to users in Brazil

Este equipamento opera em caráter secundário, isto é, não tem direito a proteção contra interferência prejudicial, mesmo de estações do mesmo tipo, e não pode causar interferência a sistemas operando em caráter primário. (Res. ANATEL 282/2001).

## Industry Canada (Canada)

This device complies with Industry Canada specification RSS-210. Operation is subject to the following two conditions: (1) this device may not cause interference, and (2) this device must accept any interference, including interference that may cause undesired operation of the device.

This device has been designed to operate only with the antenna provided. Use of any other antenna is strictly prohibited per regulations of Industry Canada.

To prevent radio interference to the licensed service, this device is intended to be operated indoors and away from windows to provide maximum shielding. Equipment (or its transmit antenna) that is installed outdoors is subject to licensing.

The installer of this radio equipment must ensure that the antenna is located or pointed such that it does not emit RF fields in excess of Health Canada limits for the general population; consult Safety Code 6, obtainable from Health Canada's Web site [www.hc-sc.gc.ca/rpb](http://www.hc-sc.gc.ca/rpb).

The term "IC:" before the certification/registration number only signifies that the Industry Canada technical specifications were met.

## Industry Canada (Canada)

Cet appareil est conforme à la norme RSS-210 d'Industry Canada. Son fonctionnement est soumis aux deux conditions suivantes :

(1) cet appareil ne doit pas provoquer d'interférences et (2) il doit accepter toute interférence reçue, y compris celles risquant d'altérer son fonctionnement.

Cet appareil a été conçu pour fonctionner uniquement avec l'antenne fournie. L'utilisation de toute autre antenne est strictement interdite par la réglementation d'Industry Canada.

En application des réglementations d'Industry Canada, l'utilisation d'une antenne de gain supérieur est strictement interdite.

Pour empêcher toute interférence radio au service faisant l'objet d'une licence, cet appareil doit être utilisé à l'intérieur et loin des fenêtres afin de garantir une protection optimale.

Si le matériel (ou son antenne d'émission) est installé à l'extérieur, il doit faire l'objet d'une licence.

L'installateur de cet équipement radio doit veiller à ce que l'antenne soit implantée et dirigée de manière à n'émettre aucun champ HF dépassant les limites fixées pour l'ensemble de la population par Santé Canada. Reportez-vous au Code de sécurité 6 que vous pouvez consulter sur le site Web de Santé Canada [www.hc-sc.gc.ca/rpb](http://www.hc-sc.gc.ca/rpb).

Le terme « IC » précédant le numéro de d'accréditation/inscription signifie simplement que le produit est conforme aux spécifications techniques d'Industry Canada.

## Taiwan NCC RF notice statement

### NCC型式認證設備注意事項 台灣低功率射頻電機設備之使用注意事項

經型式認證合格之低功率射頻電機，非經許可，公司、商號或使用者均不得擅自變更頻率、加大功率或變更原設計之特性及功能。

低功率射頻電機之使用不得影響飛航安全及干擾合法通信；經發現有干擾現象時，應立即停用，並改善至無干擾時方得繼續使用。前項合法通信，指依電信規定作業之無線電信。低功率射頻電機須忍受合法通信或工業、科學及醫療用電波輻射性電機設備之干擾。

## Notice to users in the European Union

Products bearing the CE mark are in conformity with the protection requirements of EC Council directives 2004/108/EC, 2006/95/EC, and 1999/5/EC on the approximation and harmonization of the laws of the Member States relating to electromagnetic compatibility, safety of electrical equipment designed for use within certain voltage limits and on radio equipment and telecommunications terminal equipment.

Compliance is indicated by the CE marking.



A declaration of conformity with the requirements of the directives is available from the Director of Manufacturing and Technical Support, Lexmark International, S. A., Boigny, France. Refer to the table at the end of the Notices section for further compliance information.

Products equipped with 2.4GHz Wireless LAN option are in conformity with the protection requirements of EC Council directives 2004/108/EC, 2006/95/EC, and 1999/5/EC on the approximation and harmonization of the laws of the Member States relating to electromagnetic compatibility, safety of electrical equipment designed for use within certain voltage limits and on radio equipment and telecommunications terminal equipment.

Compliance is indicated by the CE marking.



Operation is allowed in all EU and EFTA countries, but is restricted to indoor use only.

A declaration of conformity with the requirements of the directives is available from the Director of Manufacturing and Technical Support, Lexmark International, S. A., Boigny, France. Refer to the table at the end of the Notices section for further compliance information.

Česky	Společnost Lexmark International, Inc. tímto prohlašuje, že výrobek tento výrobek je ve shodě se základními požadavky a dalšími příslušnými ustanoveními směrnice 1999/5/ES.
Dansk	Lexmark International, Inc. erklærer herved, at dette produkt overholder de væsentlige krav og øvrige relevante krav i direktiv 1999/5/EF.
Deutsch	Hiermit erklärt Lexmark International, Inc., dass sich das Gerät dieses Gerät in Übereinstimmung mit den grundlegenden Anforderungen und den übrigen einschlägigen Bestimmungen der Richtlinie 1999/5/EG befindet.
Ελληνική	ΜΕ ΤΗΝ ΠΑΡΟΥΣΑ Η LEXMARK INTERNATIONAL, INC. ΔΗΛΩΝΕΙ ΟΤΙ ΑΥΤΟ ΤΟ ΠΡΟΪΟΝ ΣΥΜΜΟΡΦΩΝΕΤΑΙ ΠΡΟΣ ΤΙΣ ΟΥΣΙΩΔΕΙΣ ΑΠΑΙΤΗΣΕΙΣ ΚΑΙ ΤΙΣ ΛΟΙΠΕΣ ΣΧΕΤΙΚΕΣ ΔΙΑΤΑΞΕΙΣ ΤΗΣ ΟΔΗΓΙΑΣ 1999/5/ΕΚ.
English	Hereby, Lexmark International, Inc., declares that this type of equipment is in compliance with the essential requirements and other relevant provisions of Directive 1999/5/EC.
Español	Por medio de la presente, Lexmark International, Inc. declara que este producto cumple con los requisitos esenciales y cualesquiera otras disposiciones aplicables o exigibles de la Directiva 1999/5/CE.
Eesti	Käesolevaga kinnitab Lexmark International, Inc., et seade see toode vastab direktiivi 1999/5/EÜ põhinõuetele ja nimetatud direktiivist tulenevatele muudele asjakohastele sätetele.

Suomi	Lexmark International, Inc. vakuuttaa täten, että tämä tuote on direktiivin 1999/5/EY oleellisten vaatimusten ja muiden sitä koskevien direktiivin ehtojen mukainen.
Français	Par la présente, Lexmark International, Inc. déclare que l'appareil ce produit est conforme aux exigences fondamentales et autres dispositions pertinentes de la directive 1999/5/CE.
Magyar	Alulírott, Lexmark International, Inc. nyilatkozom, hogy a termék megfelel a vonatkozó alapvető követelményeknek és az 1999/5/EC irányelv egyéb előírásainak.
Íslenska	Hér með lýsir Lexmark International, Inc. yfir því að þessi vara er í samræmi við grunnkröfur og aðrar kröfur, sem gerðar eru í tilskipun 1999/5/EC.
Italiano	Con la presente Lexmark International, Inc. dichiara che questo prodotto è conforme ai requisiti essenziali ed alle altre disposizioni pertinenti stabilite dalla direttiva 1999/5/CE.
Latviski	Ar šo Lexmark International, Inc. deklarē, ka šis izstrādājums atbilst Direktīvas 1999/5/EK būtiskajām prasībām un citiem ar to saistītajiem noteikumiem.
Lietuvių	Šiuo Lexmark International, Inc. deklaruoja, kad šis produktas atitinka esminius reikalavimus ir kitas 1999/5/EB direktyvos nuostatas.
Malti	Bil-preżenti, Lexmark International, Inc., jiddikjara li dan il-prodott huwa konformi mal-ħtiġijiet essenzjali u ma dispożizzjonijiet oħrajn relevanti li jinsabu fid-Direttiva 1999/5/KE.
Nederlands	Hierbij verklaart Lexmark International, Inc. dat het toestel dit product in overeenstemming is met de essentiële eisen en de andere relevante bepalingen van richtlijn 1999/5/EG.
Norsk	Lexmark International, Inc. erklærer herved at dette produktet er i samsvar med de grunnleggende krav og øvrige relevante krav i direktiv 1999/5/EF.
Polski	Niniejszym Lexmark International, Inc. oświadcza, że niniejszy produkt jest zgodny z zasadniczymi wymogami oraz pozostałymi stosownymi postanowieniami Dyrektywy 1999/5/EC.
Português	A Lexmark International Inc. declara que este produto está conforme com os requisitos essenciais e outras disposições da Diretiva 1999/5/CE.
Slovensky	Lexmark International, Inc. týmto vyhlasuje, že tento produkt spĺňa základné požiadavky a všetky príslušné ustanovenia smernice 1999/5/ES.
Slovensko	Lexmark International, Inc. izjavlja, da je ta izdelek v skladu z bistvenimi zahtevami in ostalimi relevantnimi določili direktive 1999/5/ES.
Svenska	Härmed intygar Lexmark International, Inc. att denna produkt står i överensstämmelse med de väsentliga egenskapskrav och övriga relevanta bestämmelser som framgår av direktiv 1999/5/EG.



# Index

## Numerics

4 x 6 color copy button 38

## B

banner paper, loading 24

buttons, control panel

4 x 6 color copy 38

buttons, printer control panel

4 x 6 Copy 16

Black Copy 16

Cancel 16

Color Copy 16

Paper Feed 16

Power 16

Scan 16

Up arrow 16

## C

canceling

print jobs 31

scan job 39

cards

loading 24

cartridges, print

cleaning 46

installing 43

ordering 48

preserving 47

removing 44

using genuine Lexmark 45

wiping 46

cleaning exterior of the printer 47

cleaning print cartridge nozzles 46

copying 38

4 x 6 photos 38

custom-size paper, loading 24, 35

custom-size paper, printing 35

## D

document

multiple copies, printing 28

documents

loading on scanner glass 39

loading on the scanner glass 25

printing 27

scanning using the printer control panel 39

## E

emission

notices 58, 59, 65, 69, 70, 71

envelopes

loading 23, 33

printing 33

exterior of the printer

cleaning 47

## F

fax

modem 41

receiving 41

FCC notices 58, 66, 69

finding

information 6

publications 6

Web site 6

## G

glossy and photo paper,

loading 27

glossy paper, loading 22

greeting cards

loading 24

## H

heavyweight matte paper,

loading 22

## I

index cards

loading 24

information, finding 6

installing

print cartridges 43

printer software 18, 54

iron-on transfers, loading 24

## L

labels, loading 23

labels, printing 34

last page first, printing 29

loading

banner paper 24

custom-size paper 24, 35

documents on the scanner

glass 25, 39

envelopes 23, 33

glossy and photo paper 27

glossy paper 22

greeting cards 24

heavyweight matte paper 22

index cards 24

iron-on transfers 24

labels 23

paper 22, 27

photo cards 24

photo paper 22

photos on the scanner glass 25

postcards 24

transparencies 23

## M

Mac printer software

using 20

magazine articles, loading on the

scanner glass 25

modem

fax 41

multiple copies, printing 28

## N

newspapers, loading on the scanner

glass 25

noise emission levels 59

notices 58, 59, 60, 61, 65, 66, 67, 68

, 69, 70, 71

N-up feature 29

## O

ordering paper and other

supplies 48

## P

page does not print 52

paper

choosing specialty 32

paper and other supplies

ordering 48

paper exit tray 14

paper guide 14

paper support 14

- paper, loading 22, 27
- parts
  - paper exit tray 14
  - paper guide 14
  - paper support 14
  - power supply port 15
  - print cartridge carrier 15
  - printer control panel 14
  - scanner glass 14
  - scanner support 15
  - scanner unit 15
  - top cover 14
  - USB port 15
- photo cards, loading 24
- photo paper, loading 22
- photos
  - copying 4 x 6 photos 38
  - loading on the scanner glass 25
  - printing photos using FastPics or Productivity Studio 32
- postcards
  - loading 24
- power button is not lit 50
- power supply port 15
- print cartridge carrier 15
- print cartridge nozzles, cleaning 46
- print cartridges
  - cleaning 46
  - installing 43
  - ordering 48
  - preserving 47
  - refilling 45
  - removing 44
  - using genuine Lexmark 45
  - wiping 46
- print jobs, canceling 31
- print settings
  - saving and deleting 36
- printer
  - setting up without a computer 9
- printer control panel 14
  - using 16
- printer software
  - installing 18
  - reinstalling 54
  - removing 54
- printing
  - collate 28
  - custom-size paper 35
  - documents 27
  - envelopes 33

- labels 34
- last page first 29
- multiple copies 28
- multiple pages on one sheet 29
- photos using FastPics or Productivity Studio 32
- reverse page order 29
- specialty documents 36
- Web page 27
- publications, finding 6

## R

- receiving a fax 41
- recycling
  - Lexmark products 49
  - WEEE statement 60
- refilling print cartridges 45
- removing print cartridges 44
- reverse page order 29

## S

- safety information 5
- saving and deleting print settings 36
- scanner glass 14
  - cleaning 47
  - loading documents 25, 39
- scanner support 15
- scanner unit 15
- scanning
  - canceling a scan 39
  - using the printer control panel 39
- security information 9
- Service Center 50
- setup troubleshooting
  - page does not print 52
  - power button is not lit 50
  - software did not install 51
- setup, printer 9
- software
  - removing and reinstalling 54
  - Service Center 50
  - XPS driver 18
- software did not install 51
- solving printer communication problems 56
- specialty documents, printing 36

## T

- telecommunication notices 66, 67, 68, 69
- Toolbar
  - printing a Web page 27
- top cover 14
- transparencies
  - loading 23
- troubleshooting
  - printer communication problems 56
  - Service Center 50
- troubleshooting, setup
  - page does not print 52
  - power button is not lit 50
  - software did not install 51

## U

- USB port 15
  - enabling 55
- using
  - Mac printer software 20

## W

- Web page
  - printing 27
- Web site
  - finding 6
- Windows software
  - FastPics 19
  - Fax Setup Utility 20
  - Fax Solutions Software 20
  - Printing Preferences 20
  - Productivity Studio 19
  - Wireless Setup Utility 20

## X

- XPS driver
  - installing 18