



Lexmark™ X46x Maintenance Guide

Contents

Maintaining the printer.....	3
Cleaning the exterior of the printer.....	3
Cleaning the scanner glass.....	3
Cleaning the ADF separator rollers.....	4
Adjusting scanner registration.....	5
Storing supplies.....	6
Checking the status of supplies.....	7
Checking the status of supplies from the printer control panel.....	7
Checking the status of supplies from a network computer.....	7
Ordering supplies.....	8
Ordering toner cartridges.....	8
Ordering a photoconductor kit.....	8
Ordering ADF replacement parts.....	9
Moving the printer to another location.....	9
Shipping the printer.....	10

Maintaining the printer

Periodically, certain tasks are required to maintain optimum print quality.

Cleaning the exterior of the printer

- 1 Make sure that the printer is turned off and unplugged from the wall outlet.

 **CAUTION—SHOCK HAZARD:** To avoid the risk of electric shock when cleaning the exterior of the printer, unplug the power cord from the wall outlet and disconnect all cables to the printer before proceeding.

- 2 Remove all paper from the printer.
- 3 Dampen a clean, lint-free cloth with water.

Warning—Potential Damage: Do not use household cleaners or detergents, as they may damage the finish of the printer.

- 4 Wipe only the outside of the printer.

Warning—Potential Damage: Using a damp cloth to clean the interior may cause damage to your printer.

- 5 Make sure all areas of the printer are dry before beginning a new print job.

Cleaning the scanner glass

If you encounter print quality problems, such as streaks on copied or scanned images, clean the areas shown.

- 1 Slightly dampen a soft, lint-free cloth or paper towel with water.
- 2 Open the scanner cover.

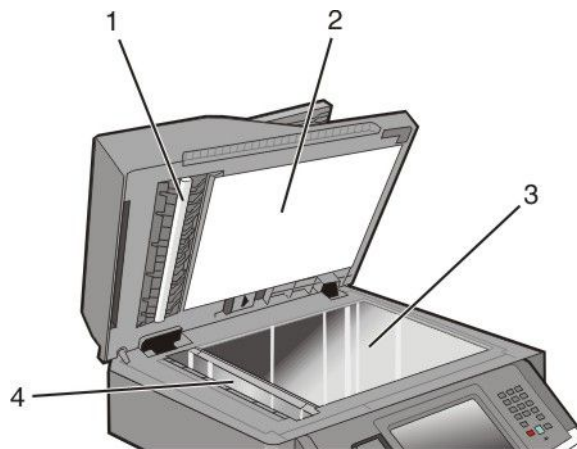

1	White underside of the ADF cover
2	White underside of the scanner cover
3	Scanner glass
4	ADF glass

- 3 Wipe the areas shown and let them dry.
- 4 Close the scanner cover.

Cleaning the ADF separator rollers

After you have copied over 50,000 copies using the ADF, clean the ADF separator rollers.

- 1 Open the ADF cover.

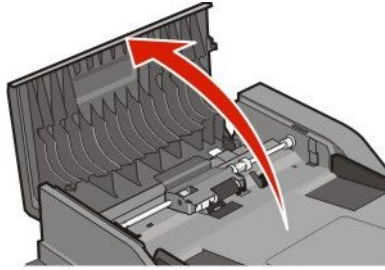

- 2 Unlock the separator roll.

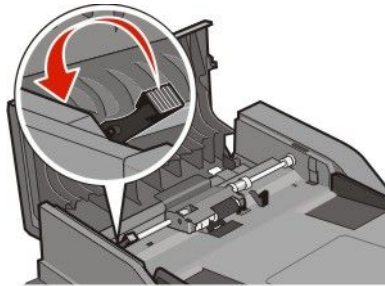

- 3 Remove the separator roll.

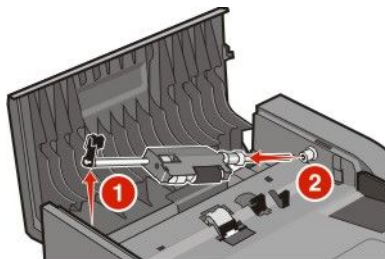

- 4 Use a clean, lint-free cloth dampened with water to wipe the separator rollers.

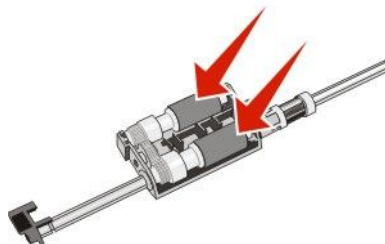

5 Reinstall the separator roll.

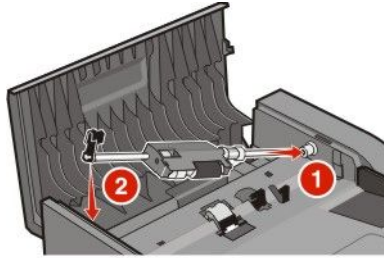

6 Lock the separator roll.

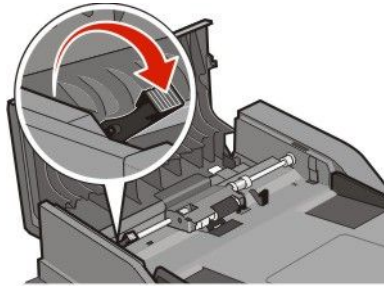

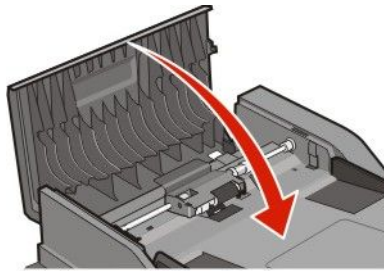

7 Close the ADF cover.



Adjusting scanner registration

Scanner Registration is a process to align the scan area with the paper location. To manually adjust the scanner registration:

- 1 Turn the printer off.
- 2 Clean the scanner glass and backing material.
- 3 Hold down  and  while turning the printer on.
- 4 Release the buttons when the screen with the progress bar appears.
The printer performs a power-on sequence, and then the Configuration menu appears.
- 5 Touch the down arrow until **Scanner Manual Registration** appears.
- 6 Touch **Scanner Manual Registration**.
- 7 Touch **Print Quick Test** to print a registration page.
- 8 Choose the section of the scanner to align.

To align the scanner glass (flatbed):

- a Place the Quick Test page facedown on the scanner glass.

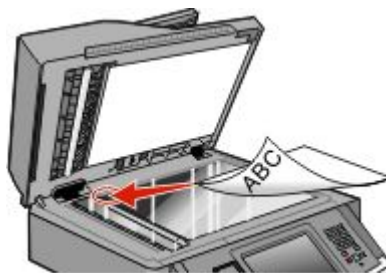

- b Touch **Copy Quick Test**.
The scanner prints a copy of the Quick Test page.
- c Touch **Flatbed**.
- d Use the copy of the Quick Test page to adjust the Left Margin and Top Margin settings.
- e Touch **Submit**.
- f Touch **Copy Quick Test** and compare the new copy to the original.
Repeat the flatbed alignment steps until the position on the page of the Quick Test copy closely matches the original.

To align the ADF:

- a Do one of the following:
 - To align the ADF front: place the Quick Test page faceup, short edge first into the ADF.
 - To align the ADF back: place the Quick Test page facedown, short edge first into the ADF.
- b Touch **Copy Quick Test**.
The scanner prints a copy of the Quick Test page.
- c Touch **ADF Front** or **ADF Back**.
- d Use the copy of the Quick Test page to adjust the Horizontal Adjust and Top Margin settings.
- e Touch **Submit**.
- f Touch **Copy Quick Test** and compare the new copy to the original.
Repeat the ADF alignment steps until the position on the page of the Quick Test copy closely matches the original.

9 Touch **Back**.

10 Touch **Exit Configuration**.

Storing supplies

Choose a cool, clean storage area for the printer supplies. Store supplies right side up in their original packing until you are ready to use them.

Do not expose supplies to:

- Direct sunlight
- Temperatures above 35°C (95°F)
- High humidity above 80%
- Salty air

- Corrosive gases
- Heavy dust

Checking the status of supplies

A message appears on the display when a replacement supply item is needed or when maintenance is required.

Checking the status of supplies from the printer control panel

1 Make sure the printer is on and **Ready** appears.

2 On the home screen, touch **Status/Supplies**.

Note: If **Status/Supplies** is not on the home screen, then print a menu settings page to review the status of the supplies.

3 Touch **View supplies**.

The View supplies screen appears, showing a summary of supply levels.

Note: The Black Cartridge gauge is only an estimate of how much toner is left in your cartridge.

Checking the status of supplies from a network computer

Note: The computer must be connected to the same network as the printer.

1 Type the printer IP address into the address field of your Web browser.

Note: If you do not know the IP address of the printer, print a network setup page and locate the IP address in the TCP/IP section.

2 Click **Device Status**. The Device Status page appears, displaying a summary of supply levels.

Ordering supplies

To order supplies in the U.S., contact Lexmark at 1-800-539-6275 for information about Lexmark authorized supplies dealers in your area. In other countries or regions, visit the Lexmark Web Site at www.lexmark.com or contact the place where you purchased the printer.

Warning—Potential Damage: Damage caused by the use of a supply or replacement item not produced by the manufacturer of this printer is not covered under warranty. Degraded print quality may result from using supplies or replacement items not produced by the manufacturer of this printer.

Note: All life estimates for printer supplies assume printing on letter- or A4-size plain paper.

Ordering toner cartridges

When **88 Cartridge low** appears or when the print becomes faded:

- 1 Remove the toner cartridge.
- 2 Firmly shake the cartridge side-to-side and front-to-back several times to redistribute toner.

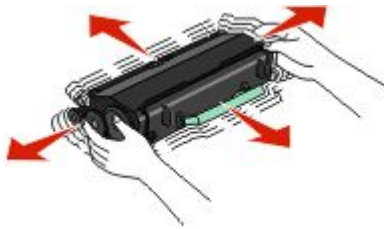

- 3 Reinsert the cartridge and continue printing.

Note: Repeat this procedure multiple times until the print remains faded, and then replace the cartridge.

Recommended toner cartridges and part numbers

Part name	Lexmark Return Program Cartridge	Regular cartridge
Toner Cartridge	X463A11G	X463A21G
High Yield Toner Cartridge	X463H11G	X463H21G
Extra High Yield Toner Cartridge	X463X11G	X463X21G

Ordering a photoconductor kit

Depending on your printer model, the printer issues a message or a light sequence to let you know the photoconductor kit is near its end of life. At this time, order a photoconductor kit. You can also see the status of the photoconductor kit by printing a network setup page.

Part name	Part number
Photoconductor kit	E260X22G

Ordering ADF replacement parts

Order ADF replacement parts if you experience problems with paper double-feeding or failing to feed through the Automatic Document Feeder.

Part name	Part number
ADF input tray	40X5470
ADF separator pad	40X5472
ADF separator roll	40X5471

Moving the printer to another location

Warning—Potential Damage: Damage to the printer caused by improper moving is not covered by the printer warranty.

CAUTION—POTENTIAL INJURY: The printer weight is greater than 18 kg (40 lb) and requires two or more trained personnel to move it safely.



CAUTION—POTENTIAL INJURY: Follow these guidelines to avoid personal injury or printer damage:

- Turn the printer off using the power switch, and then unplug the power cord from the wall outlet.
- Disconnect all cords and cables from the printer before moving it.
- Use the handholds located on both sides of the printer to lift it.
- Make sure your fingers are not under the printer when you set it down.
- Before setting up the printer, make sure there is adequate clearance around it. For more information, see the *User's Guide*.

The printer and options can be safely moved to another location by following these precautions:

- Any cart used to move the printer must be able to support its weight and have a large enough surface to support the full footprint of the printer.
- Keep the printer in an upright position.
- Avoid severe jarring movements.

Shipping the printer

When shipping the printer, use the original packaging or call the place of purchase for a relocation kit.